

HALLIS HUDSON

arc





PRECISE DESIGN MADE IN BRITAIN

Dedicated to bringing you stylish designs made to the highest of standards, we have worked with skilled artisans here on home soil, to design a collection which thanks to its simplicity, is both elegant and enduring.

Made in Britain using the finest materials, skilled craftsmen breathe life into the Arc Collection; high grade, mild steel metalwork is transformed into exquisitely finished pieces, with an inner strength thanks to its heavy gauge for unrivalled quality. Products are carefully prepared by hand and finished in an attractive palette of satin and metallic powder coated finishes, for superior resilience and durability without compromising on style.

A truly bespoke collection, Arc may be purchased as complete sets or individual components for greater flexibility, with the option to have your pole cut to your exact requirements for an easy, tailor made solution via our Cut Down Service. In addition, our made to measure bay pole service, guarantees a premium custom-made product for the perfect fit.



IT'S ALL IN THE DETAIL

Transform interior spaces with the simple lines and distinctive silhouettes of Arc. Available in a choice of 4 modern finial designs and 10 contemporary colours, Arc poles complement relaxed or refined drapes, whilst remaining minimal and discreet.

A true classic, the Ball finial is the definition of refined simplicity, with timeless appeal. The streamline Disc finial is the perfect choice to give your interior a clean, modern finish. Our Hammered Disc evokes vintage forged ironwork in a contemporary shape, with its artisanal finish and character. A simple elegantly understated style, the Stud is the perfect space-saving choice for tighter spaces.

Available as a refined 25mm pole, the Arc collection showcases the beauty and durability of powder coating finishes and allows the colour to shine through. A choice of satin tones or subtle metallic hues enhance the decorative appeal of this collection.



SOFT SILVER

A subtle shimmer gives Soft Silver its light appearance and an element of luxury, the perfect shade for any modern home, requiring a touch of opulence.



Ball

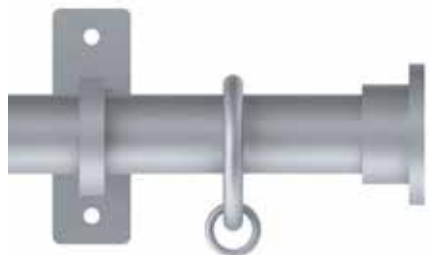

Disc

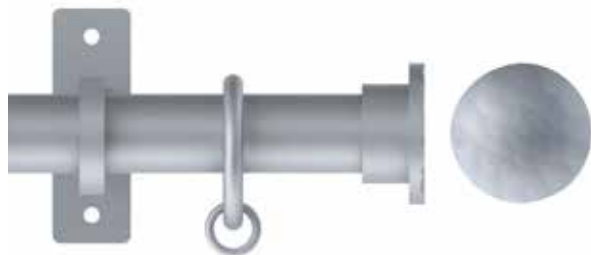

Hammered
Disc



Stud

SOFT BRASS

A lustrous shade, which will create impact whilst adding depth and dimension to the window. Pair with paler neutrals for understated glamour or with darker hues for intrigue and drama.

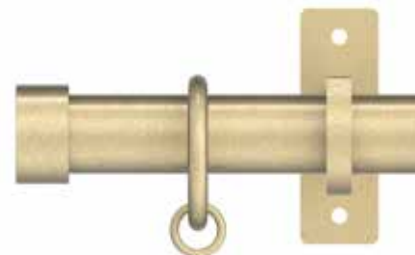
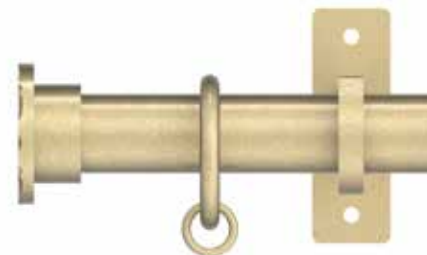
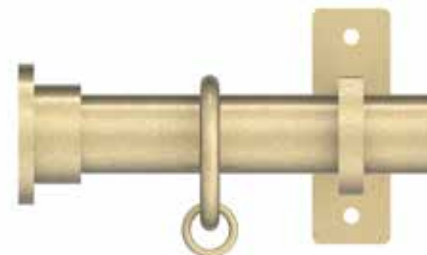
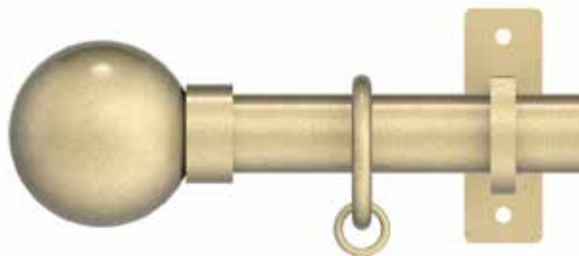

CHINA WHITE

A soft versatile white, for fresh, laid back interiors. Blend into your wall colour for a clean look, or contrast with stronger tones, for a more graphic style.



Ball

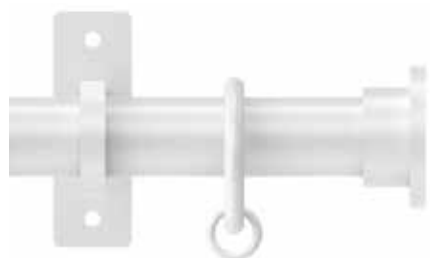

Disc

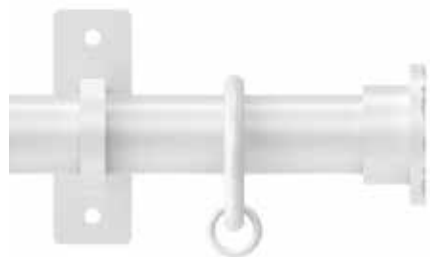

**Hammered
Disc**

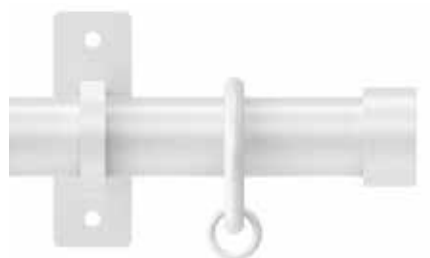

Stud

LINEN

A hushed and calm colour, our Linen shade is perfect when a warmer tone is required.



WARM GREY

A timeless grey, versatile and understated. Warm Grey works brilliantly in any setting.



Ball



Disc



Hammered
Disc



Stud

LEAD

This contemporary grey is the perfect neutral shade and the ideal complement to modern window and door frames.

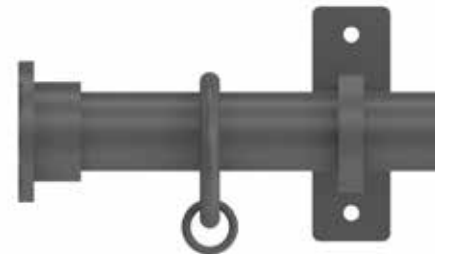
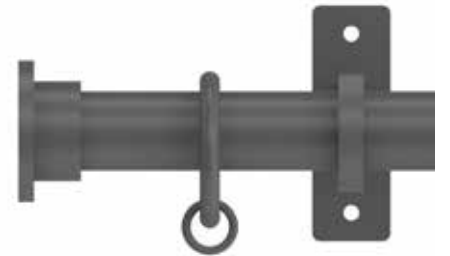

GUNMETAL

A moody hue with a modern feel, Gunmetal Grey is perfect for adding depth and dimension to any scheme.



Ball



Disc



Hammered
Disc



Stud

SOFT BLACK

Sleek satin black acts as the perfect complement to neutral colour palettes or looks chic in a more luxurious setting.



MOCHA

Deep, warm, and inviting, the Mocha shade looks good in a contemporary setting, adding richness and depth.



Ball

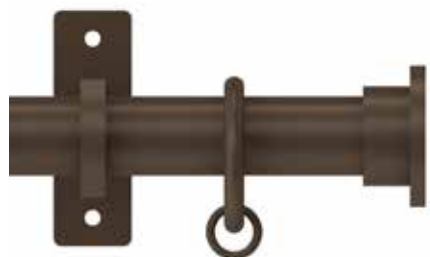

Disc



Hammered
Disc



Stud

BRONZE

A sophisticated look for timeless interiors, the subtle sheen of Bronze takes on a luxurious feel, for added lustre and glamour.

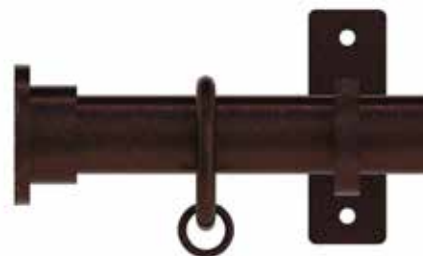
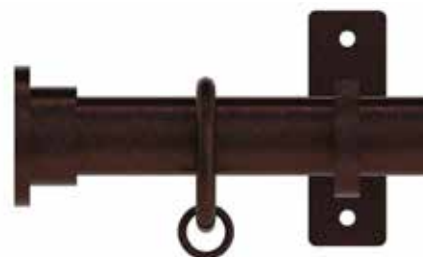







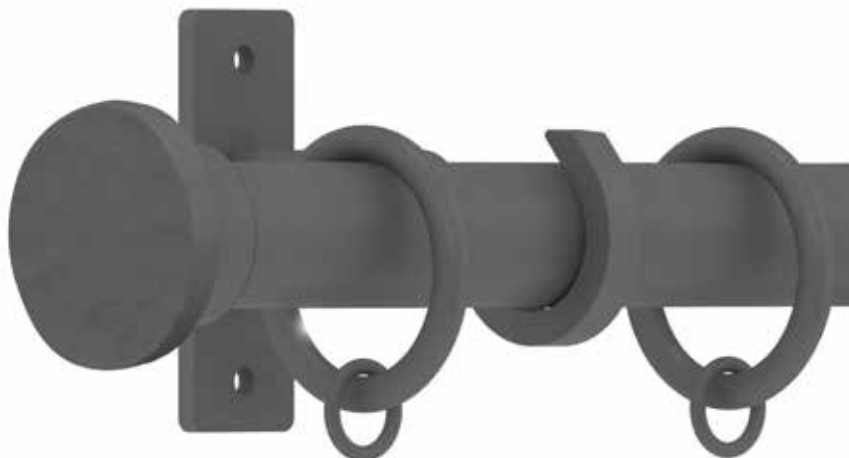





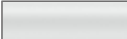

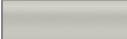
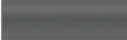
COMPLETE POLE SETS

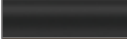
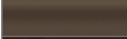
25mm
diameter



		Ball	Disc	Hammered Disc	Stud
					
	China White	AR25CWHR01/SIZE	AR25CWHR02/SIZE	AR25CWHR04/SIZE	AR25CWHR03/SIZE
	Linen	AR25LINR01/SIZE	AR25LINR02/SIZE	AR25LINR04/SIZE	AR25LINR03/SIZE
	Warm Grey	AR25WGRR01/SIZE	AR25WGRR02/SIZE	AR25WGRR04/SIZE	AR25WGRR03/SIZE
	Lead	AR25LEDR01/SIZE	AR25LEDR02/SIZE	AR25LEDR04/SIZE	AR25LEDR03/SIZE
	Gunmetal	AR25GNMR01/SIZE	AR25GNMR02/SIZE	AR25GNMR04/SIZE	AR25GNMR03/SIZE
	Soft Black	AR25SBLR01/SIZE	AR25SBLR02/SIZE	AR25SBLR04/SIZE	AR25SBLR03/SIZE
	Mocha	AR25MOCR01/SIZE	AR25MOCR02/SIZE	AR25MOCR04/SIZE	AR25MOCR03/SIZE
	Bronze	AR25BRZR01/SIZE	AR25BRZR02/SIZE	AR25BRZR04/SIZE	AR25BRZR03/SIZE
	Soft Silver	AR25SSLR01/SIZE	AR25SSLR02/SIZE	AR25SSLR04/SIZE	AR25SSLR03/SIZE
	Soft Brass	AR25SBRR01/SIZE	AR25SBRR02/SIZE	AR25SBRR04/SIZE	AR25SBRR03/SIZE

Complete Pole Sets available in lengths **150cm | 200cm | 250cm | 300cm | 400cm | 500cm | 600cm**

Poles Sets 300cm and above are supplied in two pieces with a joiner.

All Pole Sets can be personalised to your exact pole length via our Cut Down Service.

Poles of 250cm, 300cm and 400cm are supplied with 3 brackets (2 End and 1 Centre Bracket). Poles of 500cm and 600cm are supplied with 5 brackets (2 End, 2 Passing and 1 Centre Bracket).









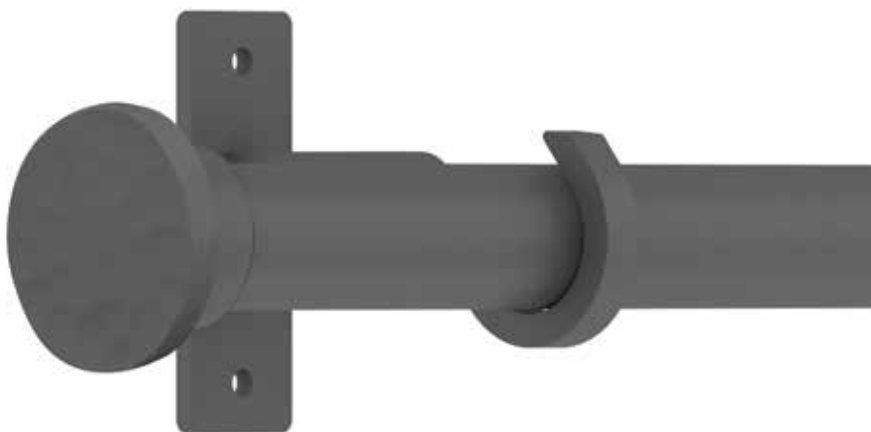

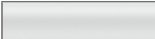

10 Rings are supplied per metre. All poles supplied with an even number of rings.

Note poles of 500cm and 600cm are supplied with passing rings, due to bracket configuration.

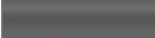

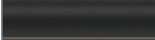
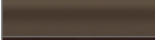
EYELET POLE SETS



		Ball	Disc	Hammered Disc	Stud
					
	China White	AR25CWHE01/SIZE	AR25CWHE02/SIZE	AR25CWHE04/SIZE	AR25CWHE03/SIZE
	Linen	AR25LINES01/SIZE	AR25LINES02/SIZE	AR25LINES04/SIZE	AR25LINES03/SIZE
	Warm Grey	AR25WGRES01/SIZE	AR25WGRES02/SIZE	AR25WGRES04/SIZE	AR25WGRES03/SIZE
	Lead	AR25LEDES01/SIZE	AR25LEDES02/SIZE	AR25LEDES04/SIZE	AR25LEDES03/SIZE
	Gunmetal	AR25GNMES01/SIZE	AR25GNMES02/SIZE	AR25GNMES04/SIZE	AR25GNMES03/SIZE
	Soft Black	AR25SBLES01/SIZE	AR25SBLES02/SIZE	AR25SBLES04/SIZE	AR25SBLES03/SIZE
	Mocha	AR25MOCES01/SIZE	AR25MOCES02/SIZE	AR25MOCES04/SIZE	AR25MOCES03/SIZE
	Bronze	AR25BRZES01/SIZE	AR25BRZES02/SIZE	AR25BRZES04/SIZE	AR25BRZES03/SIZE
	Soft Silver	AR25SSLES01/SIZE	AR25SSLES02/SIZE	AR25SSLES04/SIZE	AR25SSLES03/SIZE
	Soft Brass	AR25SBRES01/SIZE	AR25SBRES02/SIZE	AR25SBRES04/SIZE	AR25SBRES03/SIZE

Eyelet Pole Sets available in lengths **150cm | 200cm | 250cm | 300cm | 400cm**

Poles sets 300cm and above are supplied in two pieces with a joiner.

All Eyelet Pole Sets can be personalised to your exact pole length via our Cut Down Service.

Poles of 250cm and above are supplied with 3 brackets (2 End and 1 Centre Bracket).



A PERFECT FIT

Bay windows are a stunning feature in a room but can present a challenge. Our Arc Bay Poles offer an elegant, made to measure solution to suit a variety of bay window configurations, and are available in lengths of up to 5m for angled bay poles or curved poles.

Your curtain pole will be professionally bent to your exact specification, then powder coated to ensure a superior, unfurnished finish. Select up to 4 Internal bends or 1 curve and up to 2 reverse bends per pole, for a perfect fit.

To order your Arc Bay Pole use item no. **ARC/MTM**.

All bracket styles are suitable for use with bay poles and passing brackets will be supplied to support the bends. Due to the quality and thickness of the high-grade steel pole, one passing bracket per side is usually sufficient, although you may wish to request additional passing brackets for heavier applications. Where return bends are requested, an additional passing bracket is supplied per reverse bend.

Bay poles are supplied with passing rings to allow drapes to move freely along the pole. The rings are supplied at 10 per metre as standard, but the option to request 12, 14 or 16 rings per metre is available.

CURVE APPEAL

Our carefully engineered bay poles follow the curves of your window, to create a refined, custom made solution for most bay pole configurations. The simple diagrams below illustrate the various shapes you can achieve to help you find the perfect solution, for your needs.

Single Internal Bend with or without return



Two internal bends - Square or splayed, with or without returns



Four Internal Bends, with or without returns

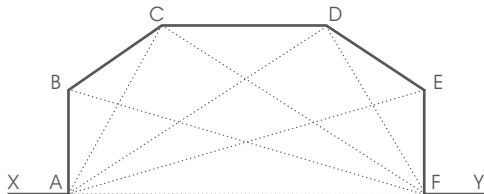

Gradual Curve, with or without returns

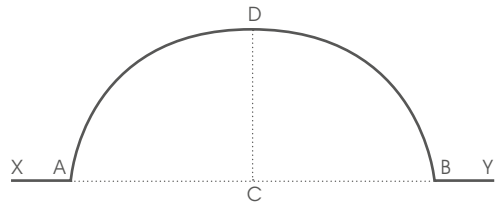

Diagrams are for representation purposes and intended as a guide to the options available only.



Internal and Reverse Bends (shown with Passing and End Brackets)



Centre Bracket



Passing Rings



Passing Bracket



INDIVIDUAL COMPONENTS & ACCESSORIES

For greater flexibility, the Arc Collection is available as individual components. Tailor the options to suit you and request poles cut to your exact lengths via our Cut Down Service, for a personalised solution.

POLE ONLY

		150cm	200cm	250cm	300cm
	China White	AR25CWH/150	AR25CWH/200	AR25CWH/250	AR25CWH/300
	Linen	AR25LIN/150	AR25LIN/200	AR25LIN/250	AR25LIN/300
	Warm Grey	AR25WGR/150	AR25WGR/200	AR25WGR/250	AR25WGR/300
	Lead	AR25LED/150	AR25LED/200	AR25LED/250	AR25LED/300
	Gunmetal	AR25GNM/150	AR25GNM/200	AR25GNM/250	AR25GNM/300
	Soft Black	AR25SBL/150	AR25SBL/200	AR25SBL/250	AR25SBL/300
	Mocha	AR25MOC/150	AR25MOC/200	AR25MOC/250	AR25MOC/300
	Bronze	AR25BRZ/150	AR25BRZ/200	AR25BRZ/250	AR25BRZ/300
	Soft Silver	AR25SSL/150	AR25SSL/200	AR25SSL/250	AR25SSL/300
	Soft Brass	AR25SBR/150	AR25SBR/200	AR25SBR/250	AR25SBR/300

Please note 300cm sets are supplied with the pole in 2 pieces and a joiner, however when sold separately as the pole only component, the pole comes in one piece.

Whilst the individual pole components do come in set lengths, you may request your exact measurements via our Cut Down Service.





INDIVIDUAL COMPONENTS & ACCESSORIES

FINIALS

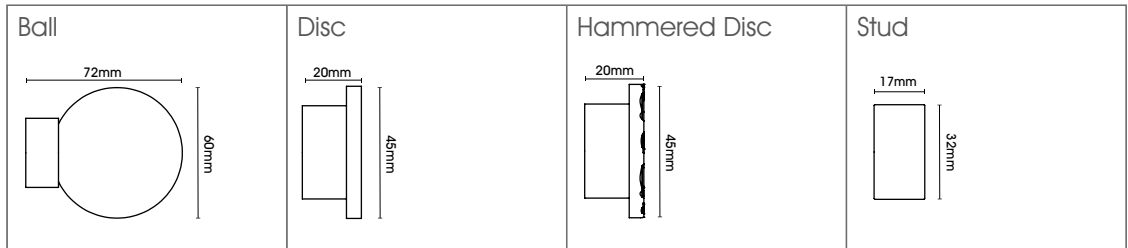

	China White	AR25CWH01	AR25CWH02	AR25CWH04	AR25CWH03
	Linen	AR25LIN01	AR25LIN02	AR25LIN04	AR25LIN03
	Warm Grey	AR25WGR01	AR25WGR02	AR25WGR04	AR25WGR03
	Lead	AR25LED01	AR25LED02	AR25LED04	AR25LED03
	Gunmetal	AR25GNM01	AR25GNM02	AR25GNM04	AR25GNM03
	Soft Black	AR25SBL01	AR25SBL02	AR25SBL04	AR25SBL03
	Mocha	AR25MOC01	AR25MOC02	AR25MOC04	AR25MOC03
	Bronze	AR25BRZ01	AR25BRZ02	AR25BRZ04	AR25BRZ03
	Soft Silver	AR25SSL01	AR25SSL02	AR25SSL04	AR25SSL03
	Soft Brass	AR25SBR01	AR25SBR02	AR25SBR04	AR25SBR03

All finials sold as singles.

INDIVIDUAL COMPONENTS & ACCESSORIES

BRACKETS

Please note curtain eyelets cannot be used with passing brackets.

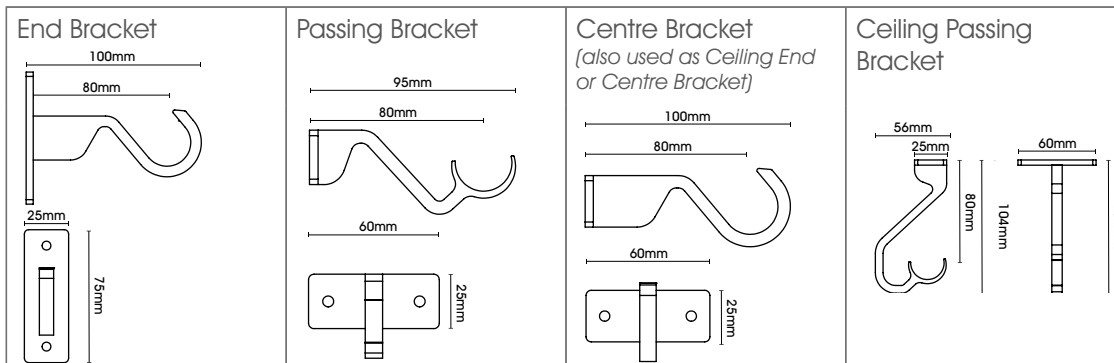

China White	AR25CWHAC10	AR25CWHAC35	AR25CWHAC14	AR25CWHAC36
Linen	AR25LINAC10	AR25LINAC35	AR25LINAC14	AR25LINAC36
Warm Grey	AR25WGRAC10	AR25WGRAC35	AR25WGRAC14	AR25WGRAC36
Lead	AR25LEDAC10	AR25LEDAC35	AR25LEDAC14	AR25LEDAC36
Gunmetal	AR25GNMAC10	AR25GNMAC35	AR25GNMAC14	AR25GNMAC36
Soft Black	AR25SBLAC10	AR25SBLAC35	AR25SBLAC14	AR25SBLAC36
Mocha	AR25MOCAC10	AR25MOCAC35	AR25MOCAC14	AR25MOCAC36
Bronze	AR25BRZAC10	AR25BRZAC35	AR25BRZAC14	AR25BRZAC36
Soft Silver	AR25SSLAC10	AR25SSLAC35	AR25SSLAC14	AR25SSLAC36
Soft Brass	AR25SBRAC10	AR25SBRAC35	AR25SBRAC14	AR25SBRAC36

All brackets sold as singles.

SINGLE POLE SYSTEMS

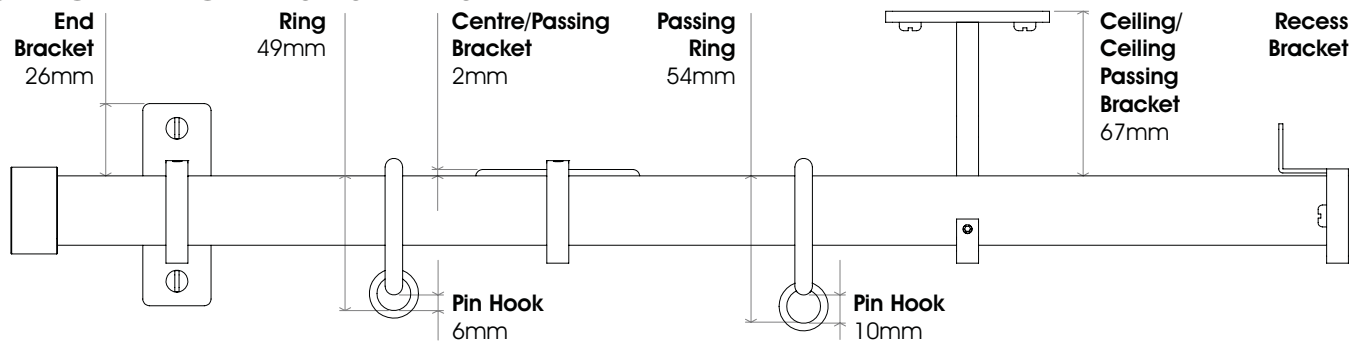

The single and double pole system diagrams below shows the relationship between the pole, the different brackets and rings, to help make calculating curtain drops easier. Please note the diagrams are for illustrative purposes only and not a normal configuration.

BRACKETS

Please note curtain eyelets cannot be used with passing brackets.

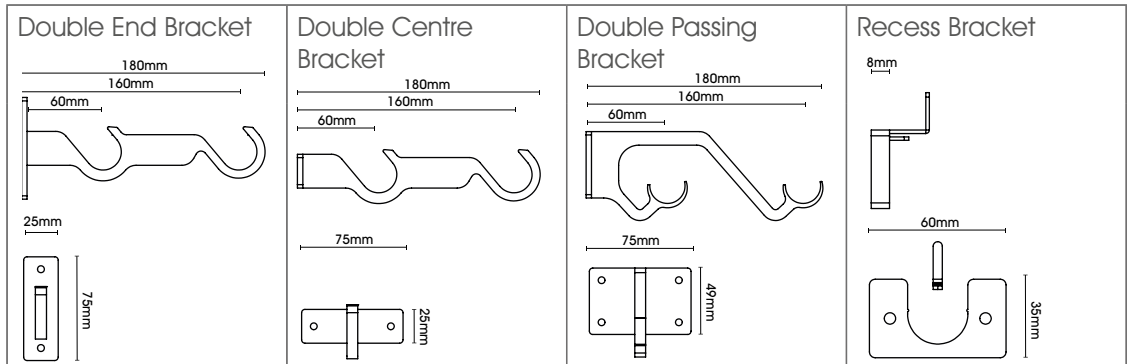

	China White	AR25CWHAC16	AR25CWHAC37	AR25CWHAC38	AR25CWHAC17
	Linen	AR25LINAC16	AR25LINAC37	AR25LINAC38	AR25LINAC17
	Warm Grey	AR25WGRAC16	AR25WGRAC37	AR25WGRAC38	AR25WGRAC17
	Lead	AR25LEDAC16	AR25LEDAC37	AR25LEDAC38	AR25LEDAC17
	Gunmetal	AR25GNMAC16	AR25GNMAC37	AR25GNMAC38	AR25GNMAC17
	Soft Black	AR25SBLAC16	AR25SBLAC37	AR25SBLAC38	AR25SBLAC17
	Mocha	AR25MOCAC16	AR25MOCAC37	AR25MOCAC38	AR25MOCAC17
	Bronze	AR25BRZAC16	AR25BRZAC37	AR25BRZAC38	AR25BRZAC17
	Soft Silver	AR25SSLAC16	AR25SSLAC37	AR25SSLAC38	AR25SSLAC17
	Soft Brass	AR25SBRAC16	AR25SBRAC37	AR25SBRAC38	AR25SBRAC17

All brackets sold as singles.

DOUBLE POLE SYSTEMS

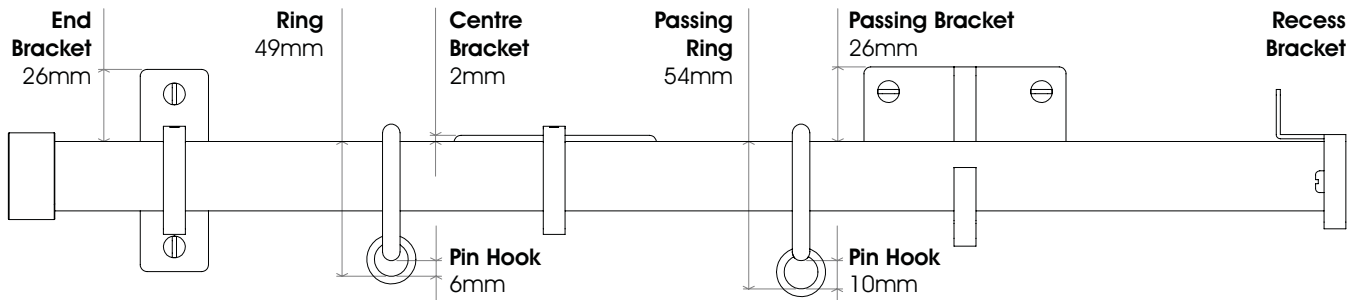



INDIVIDUAL COMPONENTS & ACCESSORIES

CURTAIN RINGS

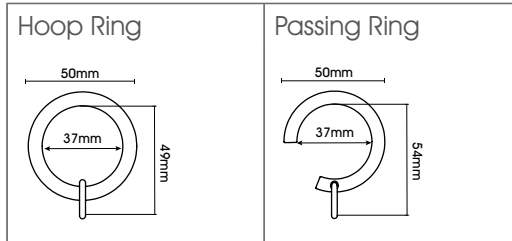

	China White	AR25CWHAC22	AR25CWHAC24
	Linen	AR25LINAC22	AR25LINAC24
	Warm Grey	AR25WGRAC22	AR25WGRAC24
	Lead	AR25LEDAC22	AR25LEDAC24
	Gunmetal	AR25GNMAC22	AR25GNMAC24
	Soft Black	AR25SBLAC22	AR25SBLAC24
	Mocha	AR25MOCAC22	AR25MOCAC24
	Bronze	AR25BRZAC22	AR25BRZAC24
	Soft Silver	AR25SSLAC22	AR25SSLAC24
	Soft Brass	AR25SBRAC22	AR25SBRAC24

Sold as packs of 4 rings.

HOLD BACK

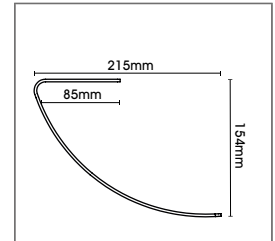

	China White	AR25CWHAC32
	Linen	AR25LINAC32
	Warm Grey	AR25WGRAC32
	Lead	AR25LEDAC32
	Gunmetal	AR25GNMAC32
	Soft Black	AR25SBLAC32
	Mocha	AR25MOCAC32
	Bronze	AR25BRZAC32
	Soft Silver	AR25SSLAC32
	Soft Brass	AR25SBRAC32

Sold as singles.

JOINER

One Option	AR25AC30
------------	-----------------

Sold as singles.



Item No. BROCH/ARC



HALLIS HUDSON
Committed to excellence

Hallis Hudson Group Ltd, Unit C34, Red Scar Business Park,
Longridge Road, Preston, Lancashire, PR2 5NN
Sales Tel: 01 772 202 202 | Sales Fax: 01 772 515 515
Email: sales@hallishudson.com | Shop: www.halliswebshop.com

www.hallishudson.com