

E EDGE SI 332 AC
E EDGE SI 620 AC
E EDGE SI 1012 AC

E EDGE MI 332 AC
E EDGE MI 632 AC
E EDGE MI 1020 AC



Tubular Motor

EN - Instructions and warnings for installation and use

GENERAL WARNINGS: SAFETY - INSTALLATION - USE (original instructions in Italian)

ATTENTION Important safety instructions. Follow all instructions as improper installation may cause serious damage
ATTENTION Important safety instructions. It is important for you to comply with these instructions for your own and other people's safety. Keep these instructions

- Before commencing the installation, check the "Technical characteristics" (in this manual), in particular whether this product is suitable for automating your guided part. If it is not suitable, DO NOT continue with the installation
- The product cannot be used before it has been commissioned as specified in the chapter on "Testing and commissioning"

ATTENTION According to the most recent European legislation, the implementation of an automation system must comply with the harmonised standards provided by the Machinery Directive in force, which enables declaration of the presumed conformity of the automation. Taking this into account, all operations regarding connection to the electricity grid, as well as product testing, commissioning and maintenance, must be performed exclusively by a qualified and skilled technician!

- Before proceeding with the installation of the product, check that all the materials are in good working order and suited to the intended applications
- This product is not intended to be used by persons (including children) whose physical, sensory or mental capacities are reduced, or who lack the necessary experience or skill
- Children must not play with the appliance
- Do not allow children to play with the fixed control devices of the product. Keep the remote controls away from children

ATTENTION In order to avoid any danger from inadvertent resetting of the thermal cut-off device, this appliance must not be powered through an external switching device, such as a timer, or connected to a supply that is regularly powered or switched off by the circuit

- Provide a disconnection device (not supplied) in the plant's power supply grid, with a contact opening distance permitting complete disconnection under the conditions dictated by overvoltage category III
- Handle the product with care during installation, taking care to avoid crushing, denting or dropping it, or allowing contact with liquids of any kind. Keep the product away from sources of heat and naked flames. Failure to observe the above can damage the product, and increase the risk of danger or malfunction. Should this happen, stop installation immediately and contact Customer Service
- The manufacturer assumes no liability for damage to property, items or persons resulting from non-compliance with the assembly instructions. In such cases the warranty for material defects is excluded
- The weighted sound pressure level of the emission A is lower than 70 dB(A)
- Cleaning and maintenance to be carried out by the user must not be carried out by unsupervised children
- Before working on the system (maintenance, cleaning), always disconnect the product from the mains power supply
- Check the system periodically, in particular all cables, springs and supports to detect possible imbalances, signs of wear or damage. Do not use, if repairs or adjustments are necessary, since installation failure or an incorrectly balanced automation may cause injury
- The packing materials of the product must be disposed of in compliance with local regulations
- There must be at least 0.4 m between the driven parts and any fixed elements
- The wording on the tubular motors can be covered after assembly
- Motor with **fixed** power cable: the power cable **cannot be replaced**. If the cable is damaged, the appliance must be scrapped
- Motor with **removable** power cable and dedicated connector: if the power cable is damaged, it **must be replaced** by the manufacturer or by the latter's technical assistance service, or by a similarly qualified person, in order to prevent any type of risk.
- Be careful with moving shutters and keep away from them until they have lowered fully
- Be careful when activating the manual release device, as a raised shutter may rapidly drop in case of weak or broken springs
- Do not activate the awning when maintenance activities – such as window cleaning – are being carried out nearby
- Disconnect the awning from the power supply when maintenance activities such as window cleaning are being carried out nearby. Warning for 'shades with automatic control'

INSTALLATION WARNINGS

- Prior to installing the drive motor, remove any unnecessary cables and disable any appliance not required for motorised operation
- Install the manoeuvring assembly for manual release at a height below 1.8 m
NOTE: if removable, the manoeuvring assembly must be kept close to the door
- Make sure that the control devices are kept far from moving parts but nonetheless in a visible position.
The manoeuvring assembly of a switch kept manually closed must be located in a position visible from the guided part but far from moving parts. It must be installed at a minimum height of 1.5 m
- The fixed control devices must be installed in a visible position
- For drive motors that allow for accessing unprotected moving parts once they have been installed, such parts must be installed 2.5 m above the floor or other surface from which they can be accessed

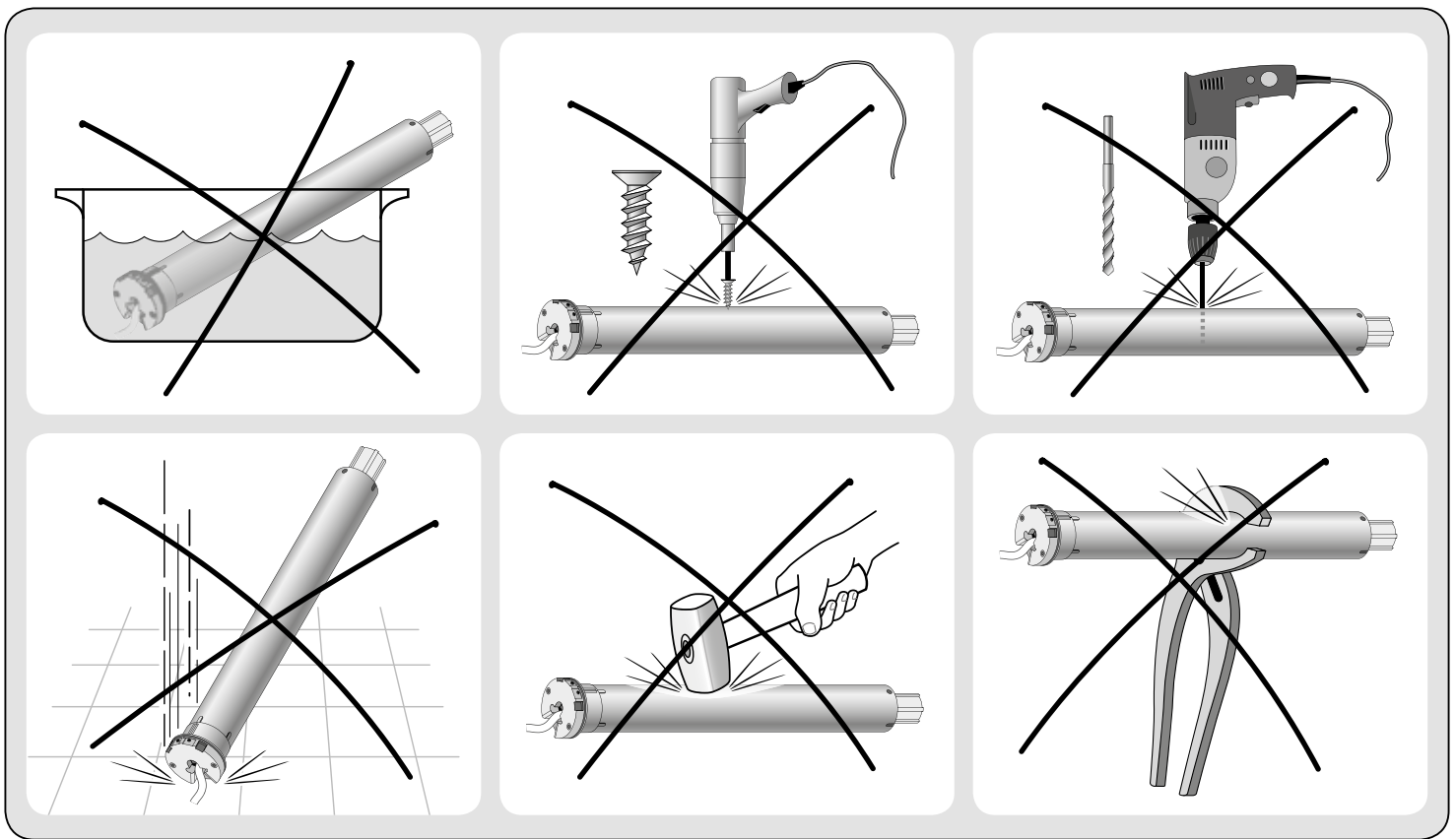

1 PRODUCT DESCRIPTION AND INTENDED USE

This product is a tubular motor for automating indoors roll-up awnings, or indoors sunscreens, or similar roll-up equipment (**fig. 1**). **Do not use it for any other purpose! The manufacturer declines all liability for damage resulting from improper use of the product or any other use than that specified in this manual.**

The product has the following functional characteristics:

- it is mains powered (see the motor's nameplate ratings);
- it has two separate cables: one power cable and one control cable;
- it installs inside the winding roller; the part of the motor that protrudes from the roller (electronic head) mounts to the ceiling or wall with brackets (not included);
- it has a built-in radio receiver and control unit with encoder technology that electronically controls the movement and precision of the limit switches;
- it is compatible with all Nice control electronics using the NRC radio system (climate sensors and transmitters);
- it can be programmed with a compatible radio transmitter ("ERA P" / "ERA W" series). These have two keys on their backs which serve only for programming, and which are protected by a cover to prevent accidental reprogramming. The programming can also be done with a dedicated programming unit (TTP, etc.), or wall-mounted button panel. These accessories (including portable radio transmitters) are not included;
- it can be controlled with a radio transmitter or cabled wall-mounted button panel (see **fig. 2**). These accessories are not included;
- it can move the awning up or down; stop it at the upper limit switch, the lower limit switch or various intermediate positions.
- it moves awnings of different weights at the same speed;
- the up and down speeds are the same;
- it allows you to set the nominal awning speed, so that the user can select three commands: "fast", "nominal" and "silent-soft";
- it enables you to adjust the movement's duration;
- it enables you to set the acceleration and deceleration at the start/end of the movement respectively;
- it features a security system that detects the presence of an obstacle along the awning travel, immediately blocking the movement in progress and performing a brief inversion of movement. The same system is automatically activated at the end of the Up movement (only if the upper limit switch "0" consists of a box or other mechanical stop), to mitigate the impact of the awning against the housing and loosen the tension exerted by the motor on the canvas, when the awning is stationary at the upper limit switch "0";
- it enables you to customise the radio transmitter commands (Mode II);
- it enables you to set the functional logic of a button panel's buttons;
- it enables you to precisely adjust the limit switches with the buttons on the motor head;
- it has an integral led which indicates the system status and any malfunctions;
- it is equipped with a thermal protection system which, in the case of overheating caused by overuse of the automated mechanism (beyond the indicated limits, see the Technical Specifications chapter), automatically cuts off the electricity supply,

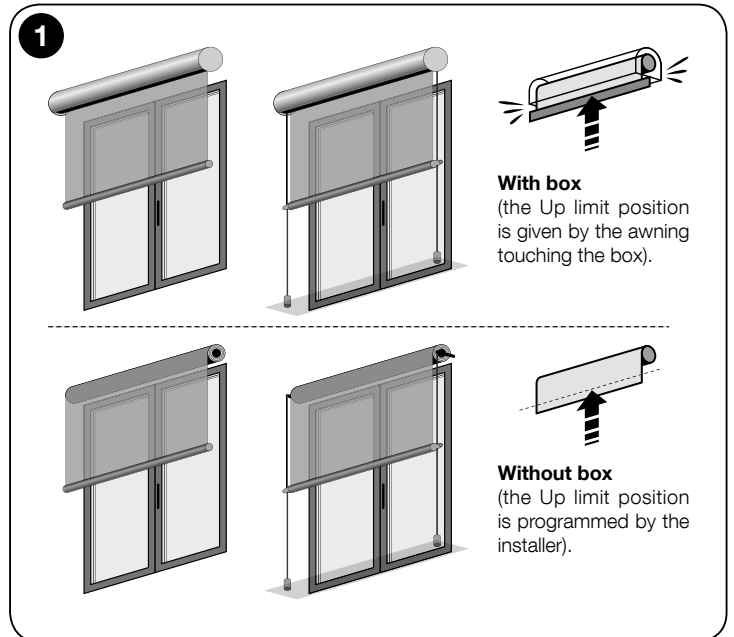

- restoring it as soon as the temperature goes back to normal;
- it is available in a variety of versions, each with a specific motor torque (see the motor nameplate ratings).

2

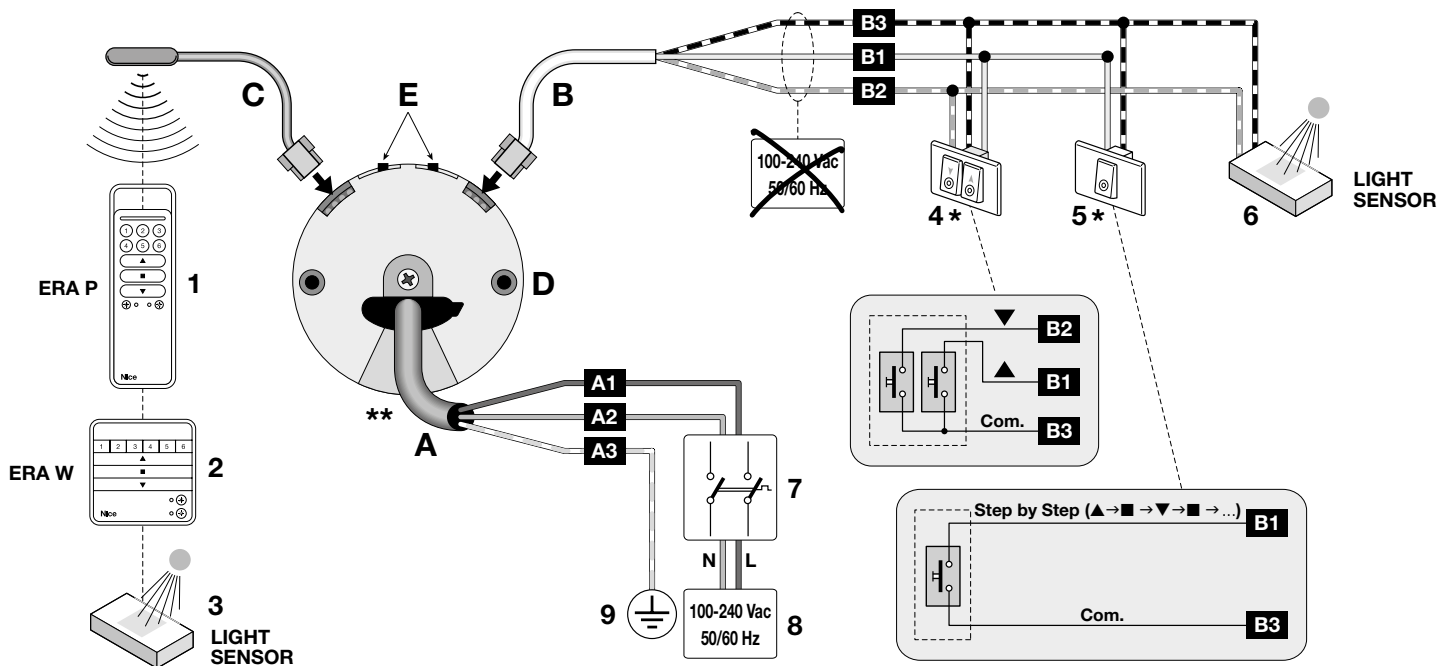

EN USA (UL)	
A	A1 White
	A2 Black
	A3 Green/Yellow-green

* DRY CONTACT
 ** THE POWER CABLE IS REMOVABLE

LEGEND	
A	Power cable
	A1 = Brown wire
	A2 = Blue wire
	A3 = Yellow-green wire
B	Command cable
	B1 = White wire
	B2 = White-orange wire
	B3 = White-black wire
C	Aerial cable
D	Electronic motor head
E	Limit switch adjustment buttons
1	"ERA P" portable transmitter.
2	"ERA W" portable transmitter
3	Climate sensor (radio)
4	Double button
5	Single button ("Open" or "Step-by-Step" command)
6	Climate sensor (wired)
7	Motor mains power disconnecter
8	Connection to the mains
9	Earth connection

2 INSTALLATION OF THE MOTOR AND THE ACCESSORIES

2.1 - Preliminary checks before installation and limitations on use

- Check the condition of the product right after unpacking it.
- Make sure that the torque, the rotation speed and time of operation of this motor are suitable for automating your awning. In particular, **do not install the motor if its torque is greater than that needed to move your awning**. To choose the right motor to the technical features of your awning refer to the the "Guide to Selection" section, in the "Nice Screen" catalogue, – also available on www.niceforyou.com.
- Check the diameter of the winding roller. This must be chosen according to the motor torque, as follows:
 - For motors of size "S" (Ø = 35 mm) the minimum inside diameter of the winding roller must be 40 mm;
 - For motors of size "M" (Ø = 45 mm) the minimum inside diameter of the winding roller must be 52 mm;
- Additional limitations on use are listed in chapters 1 and 2 and in the technical characteristics on the nameplate.

2.2 - Assembling and installing the tubular motor

Caution! – Read the safety warnings before proceeding. Incorrect installation could cause severe physical injury.

To assemble and install the motor, refer to **fig. 3** (the accessories shown in **fig. 3** are not included in the package). To select the limit switch gear wheel (**fig. 3-a**), drive wheel (**fig. 3-b**), motor bracket (**fig. 3-f**), or to select supplementary cables (of different lengths), refer to the "Nice Screen" catalogue, which is also available on www.niceforyou.com.

2.3 - Installation of accessories

After installing the motor, install the accessories, if required. In order to identify those that are compatible and choose the models desired, see the "Nice Screen" catalogue, which is also available on www.niceforyou.com. **Fig. 2** shows the type of accessories that are compatible and their connection to the motor (all of these are options and not included in the package).

3 a

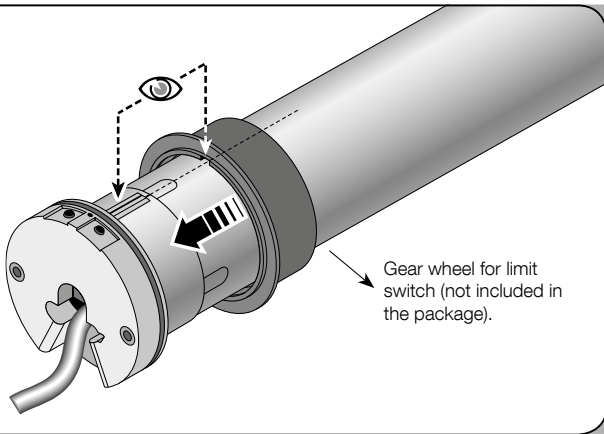

e

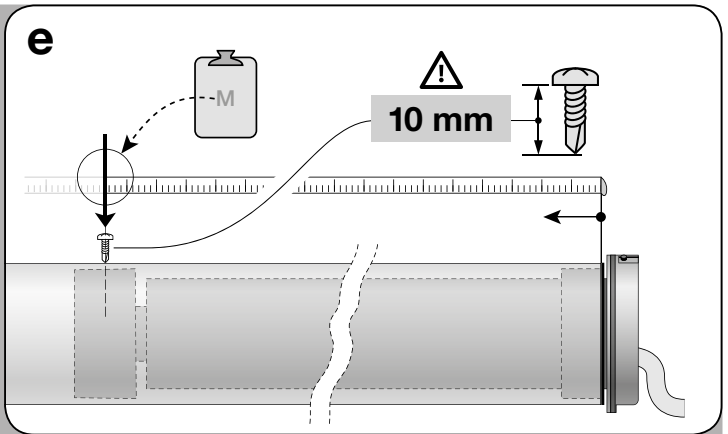

b

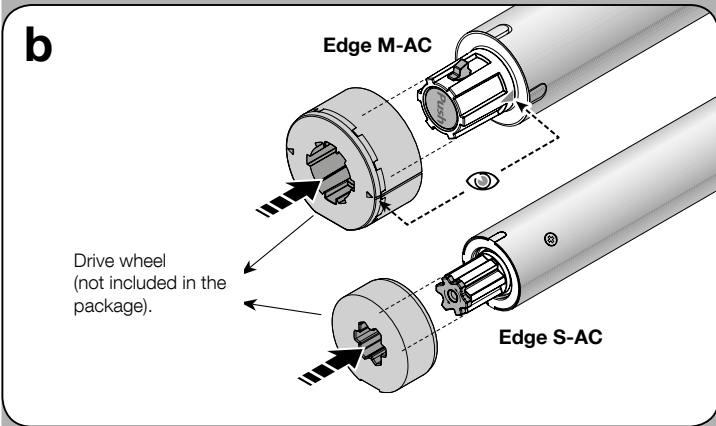

f

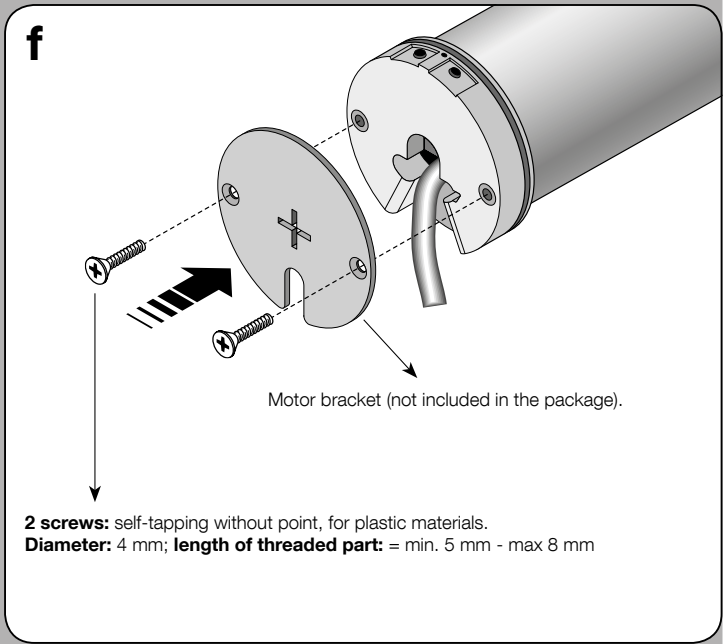

c

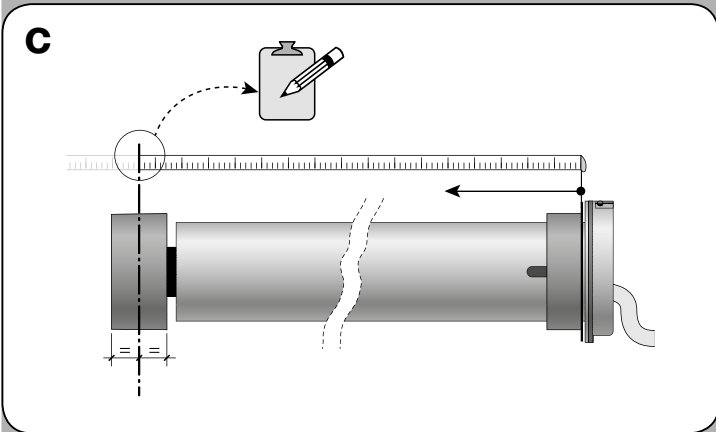

d

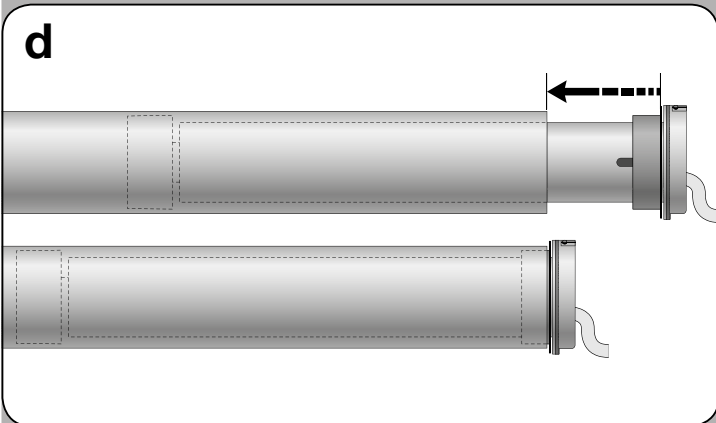

g

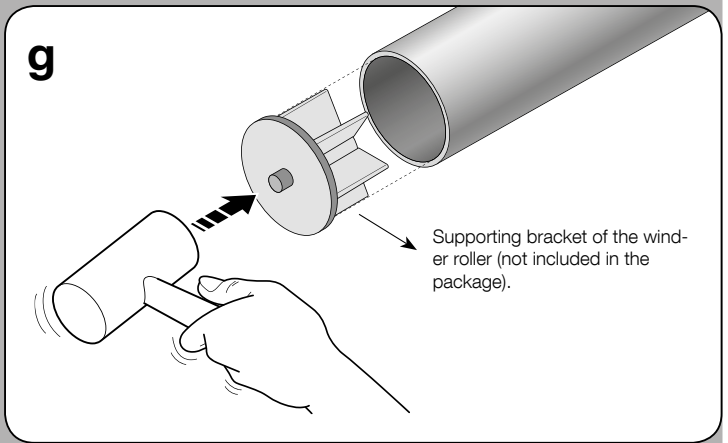

h

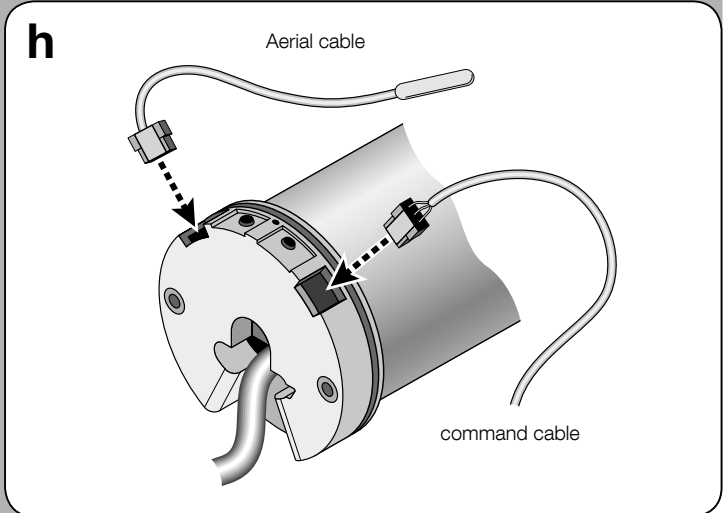

3 i For eventual extraction of the connector

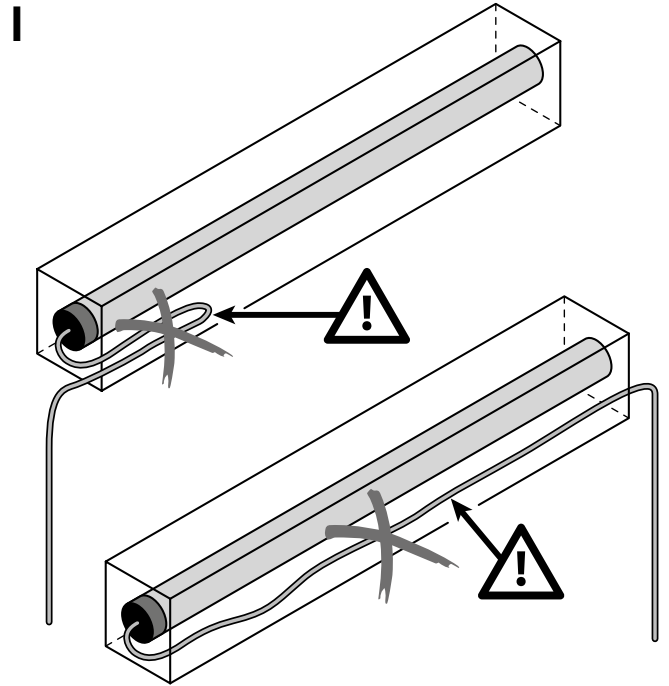
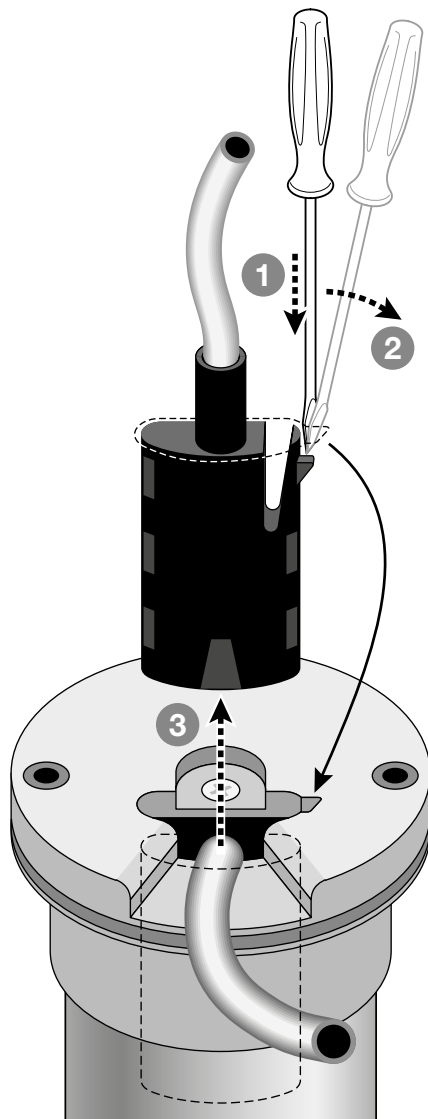

CAUTION! - The smaller cables must be handled carefully because they contain very thin wires that could be damaged.

3 ELECTRICAL CONNECTIONS AND FIRST POWER UP

The motor has **two separate cables**: the power cable and the control cable. Each cable has a connector for connection to the motor (fig. 3-h); the connectors are removable and allow the possible replacement of cables (fig. 3-i). **CAUTION!** - The smaller cables must be handled carefully because they contain very thin wires that could be damaged.

CABLE "A" is the POWER cable (fig. 2)

Wire	Colour	Connection	
A1	Brown	Power supply phase	OFF 
A2	Blue	Neutral	
A3	Yellow-green	Earth	

CABLE "B" is the CONTROL cable (fig. 2)

Wire	Colour	Connection	
B1	White	Voltage free contact for the Up command	OFF 
B2	White-orange	Voltage free contact for the Down command / TTBus	
B3	White-black	Common	

CAUTION! - DO NOT connect any wires from cable "B" to the power line.

3.1 - Connection of motor to electricity mains

The motor is powered by a permanent connection to the mains. Use cable "A" (fig. 2) for this connection, making sure to observe the warnings in full.

3.2 - Connecting pushbutton panels

You can connect either 1 or 2 button panels.

Caution! - The maximum length of the cables used to connect a wall-mounted panel or a relay is 100 m.

- **Model with 1 button** excites an input: the command is either Open (factory setting) or Step-by-step; the command is memorised with procedure A.11. The panel must be connected to the **white** and **white-black** wires.
- **Model with 2 buttons** excites two inputs: one for the Up command, and one for the Down command; it is also possible to program the operating logic using procedure A.9. The **Open** and **Close** inputs are constrained to reach other, in other words they must be used with the same pushbutton panel (fig. 2).

3.3 - Connecting accessories and sensors

- **Cabled accessories**: use cable "B" referring to fig. 3 and the following instructions.
 - You can connect only one compatible accessory at a time to the **white** and **white-black** cables.
 - You can connect only one compatible accessory at a time to the **white-orange** and **white-black** cables.
 - Up to 5 tubular motors can be connected to one accessory, respecting the polarity of the signals (connect the **white-black** cables of all motors together as well as the **white-orange** cables of all motors).
- **Wireless accessories**:
 - These are either portable transmitters or climate sensors. For how to program/memorise them, refer to the procedures given in this manual and in the device manuals themselves.

4 PROGRAMMING AND ADJUSTMENTS

4.1 - Groups of programming and adjustment procedures

There are 5 groups of programming and adjustment procedures:

Group A – done with a <u>transmitter</u> .	Procedures which can only be completed with a Nice “ERA P” or “ERA W” transmitter with the ▲, ■, ▼, PRG, ESC keys.
Group B – using the <u>buttons on the motor head</u> .	Manual adjustment of the limit switches, with precise, accurate results.
Group C – done with a <u>dedicated programmer</u> .	Programming with a programmer or other compatible accessory (for instance: TTP).
Group D – done with a wall <u>mounted button panel</u> with up and down buttons.	Procedures for programming and operating the automation at the “ basic level ”, i.e, programming or deleting only the limit switches. Note – the buttons must NOT be interlocked.
Group E – done with a <u>smartphone</u> .	Programming with a smartphone with NFC (Near Field Communication). This technology is not yet available on this motor.

4.2 - Positions in which the awning stops automatically

The electronic system that controls the awning movement at all times can automatically stop the motor when the awning reaches a certain position (or “height”) programmed by the installer. The positions are shown in **fig. 4** as follows:

- position “0” = **UP limit** (awning completely retracted);
- position “1” = **DOWN limit** (awning completely extended);
- position “H” = **INTERMEDIATE position** (awning partially open)

4.3 - General warnings

- The limit switch must be adjusted after installing the motor in the awning and connecting it to the power supply.
- Comply strictly with the time limits indicated in the procedures: after releasing a key, you have 60 seconds to press the next key indicated in the procedure; otherwise, when the time is up, the motor will perform 6 movements to communicate cancellation of the procedure in progress.
- During programming the motor performs a certain number of **brief movements** as a “response” to the command sent by the installer. Count these movements regardless of their direction. The movements are indicated in the procedures with a number followed by the symbol \updownarrow .

4.4 - Important warnings for memorising the radio transmitters

- To select transmitter compatible with the motor’s receiver, refer to the “Nice Screen” catalogue, which is also available on www.niceforyou.com.
- When no transmitter is yet present in the motor’s memory, memorise **the FIRST TRANSMITTER** with procedure A.1 only. If one or more transmitters have already been memorised, to memorise **SUPPLEMENTARY TRANSMITTERS** use one of procedures A.6 only.

4.4.1 - Two procedures to memorise the keys of a transmitter

There are two categories of transmitter memorisation procedures:

A - Procedures which memorise the buttons in “Mode I” (“Standard mode”)

These are procedures **A.1 - A.6.1.A - A.6.1.B**. These allow you to memorise all buttons **at the same time**, so that each button corresponds to a basic motor command in a standard fashion.

B - Procedures which memorise the buttons in “Mode II” (“Custom mode”)

These are procedures **A.6.2.A - A.6.2.B**. These allow you to memorise individual buttons and map them to any of the commands given in the motor’s

“list of commands” (this list is given in each procedure). The button and the command are selected by the installer, as required by the installation.

4.4.2 - Maximum number of transmitters that can be memorised

The motor has **30 memory locations**. A location can either memorise a single transmitter (in Mode I) or a single button (in Mode II) or a single wireless climate sensor (up to 5 sensors).

4.5 - Programming multiple motors with a single channel transmitter

In such cases, to avoid the need to disconnect all motors you do not wish to program, proceed as follows:

- 1) - run procedure A.1 to memorise the first transmitter on the motor you wish to program;
- 2) - run procedure A.2 to deactivate all other previously memorised motors, which you do not wish to program;
- 3) - program the motor as required, leaving the limit switches to last (*);
- 4) - at the end, reactivate the previously deactivated motors by pressing **ESC**.

(*) **Note** – If you wish to program the “movement duration”, run the procedure in question (A.14) only after having programmed the limit switches.

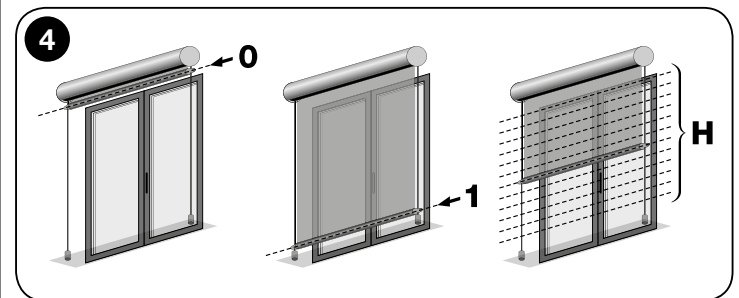

— GROUP “A” PROCEDURES —

Procedures which can only be completed with a Nice “ERA P” or “ERA W” transmitter with the ▲, ■, ▼, PRG, ESC keys

GENERAL WARNINGS RELATING TO THE PROCEDURES

- Before starting any programming, move the awning to an intermediate position, away from the Up and Down limit switches.
- If the programming transmitter controls **multiple groups of screen motors**, before sending a command requested by the procedure, select the group to which the motor being programmed belongs.
- When the motor is powered up, if it makes **2 movements** this means that: at least one transmitter has been memorised and no limit switch has been programmed; if, on the other hand, it makes **1 movement** this means that: no transmitter has been memorised.
- When running a procedure, you can abort the procedure at any time by pressing **ESC** (on the back of the transmitter).
- When the Up and Down limit switches are not programmed, the awning can only be commanded in hold-to-run mode - i.e. you must hold the button down until the awning reaches the desired position. The movement stops when you release the button in any position.
- When the Up and Down limit switches have been programmed, the awning can be controlled by simply pressing and releasing the buttons. Doing so starts the movement, which is stopped automatically by the system when the awning reaches the programmed position.
- All procedures require you to use a transmitter memorised in “Mode I” (e.g., memorised with procedure A.1 or with procedure A.6.1.A or A.6.1.B).

A **A.1 - Memorising the FIRST TRANSMITTER** (in “Mode I”)

NOTES AND WARNINGS

- This procedure must be used only for memorising the FIRST TRANSMITTER. If **the motor does not complete the procedure, this is because at least one transmitter has already been memorised**; to memorise supplementary transmitters, you must use the procedures described in section A.6.
- If all transmitters memorised in the motor are deleted, the first transmitter you memorise thereafter must be memorised with this procedure.
- If the installation has multiple motors, the procedure must be repeated for each motor separately.
- On completing this procedure, button ▲ will Raise the awning, button ▼ Lower it, and button ■ Stop the movement.
- If within the transmitter's range there are multiple powered up motors, to memorise the first transmitter in any one of them, **it is not necessary to disconnect power to all other motors**; simply proceed as follows.

1	2	3			
Move the awning to a half-way position.	Switch on mains power,	count 1 movement.	Hold down the button and	release it after 5 seconds ;	over the next 2 minutes , all motors within the transmitter's range in which no transmitters have yet been memorised will move their awnings up and down, for random periods of time.

4			→ 5
Select the <u>awning</u> you wish to program and, at the start of an UP movement , stop it IMMEDIATELY , by pressing and releasing the button (1 time):		the movement will stop briefly (= command received) and the awning will resume its up and down movements, each of random duration.



5			end
Observe the <u>same awning</u> and, at the start of a DOWN movement , stop the movement IMMEDIATELY , by pressing and releasing the button (1 time):		the movement will stop;	count 3 movements.

A A.2 - Temporarily deactivating (and reactivating) motors you do not wish to program

NOTES AND WARNINGS

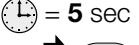

- This procedure temporarily deactivates (for 5 minutes) only motors whose up and down limit switches have already been programmed.

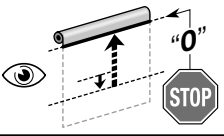
A.2.1 - To temporarily deactivate motors you do not wish to program

1		2		end
 Hold down the button and	 release it after 5 seconds ;	 you will see a brief down movement and a movement which stops the awning at the Up limit "0".	The system locks out only those motors whose limit switches have already been programmed. It has no effect on motors which have not yet been programmed. The deactivation is temporary and lasts for 5 minutes.	
			For a period of 5 minutes, the locked out motors will not respond to commands.	

A.2.2 - To reactivate temporarily locked out motors

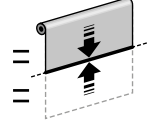
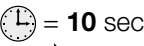
You can reactivate the motors in two ways:

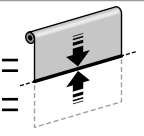



option - A		option - B			
1	end	1	end	end	end
After 5 minutes the locked out motors are <u>automatically reactivated</u> by the system.		During the 5 minute period the locked out motors can be <u>reactivated</u> at any time by the user.	 		
Wait for 5 minutes the system will then move the awning to the mid position.	During the 5 minutes , at any time...	... hold down the button and	release it after 10 seconds ;	the system will then move the awning to the mid position.

A A.3 - MANUAL programming of the UP ("0") and DOWN ("1") limit switches

NOTES AND WARNINGS

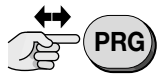
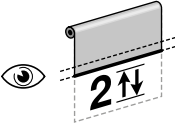
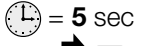
- **This procedure is obligatory only for awnings without a mechanical stop at the Up position.**
- This procedure can be used if the limit switches have been programmed using the semiautomatic procedure (A.4).
- After the limit positions have been programmed, the awning can be controlled by simply pressing the appropriate buttons on the control unit. The awning will move between the positions set with procedures A.3.1 and A.3.2.

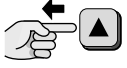
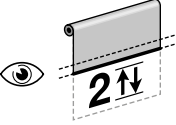
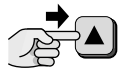
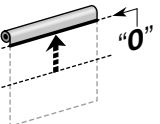
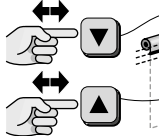
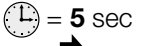
A.3.1 - To program the UP limit switch ("0")

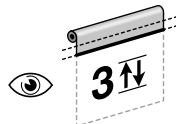
1		2		3		continues →	
 Press and release the button (1 time);	 count 2 movements.	  Hold down the button and	 release it after 5 seconds ;	 count 2 movements.	Command an UP movement → 		
→ 3		4		5		end	
 ... release the button as soon as the awning reaches position "0" (UP limit switch).		Finely adjusting the position of limit switch "0" →  Press the buttons until you reach the desired position. Alternatively , for more accurate adjustment, run procedure B.1.		  Hold down the button and		 release it after 5 seconds ;	 count 3 movements.

A.3.2 - To program the DOWN limit switch ("1")

1		2			3 continues →	
						Command an DOWN movement →
Press and release the button (1 time);	count 2 movements.	Hold down the button and	release it after 5 seconds ;	count 2 movements.	Hold down the button and wait...	
→ 3		4			5 end	
		Finely adjusting the position of limit switch "1" → 				
... release the button as soon as the awning reaches position "1" (DOWN limit switch).		Press the buttons until you reach the desired position. Alternatively , for more accurate adjustment, run procedure B.1.			Hold down the button and	
					release it after 5 seconds ;	
					count 3 movements.	

A.4 - SEMIAUTOMATIC programming of the UP ("0") and DOWN ("1") limit switches

NOTES AND WARNINGS

- Use this procedure solely for awnings with mechanical Up "0" limit switch stop.
- If the limit switches have been programmed using the manual procedure (A.3), before you can use this procedure you need to perform a total or partial deletion of memory (A.8.1 option 'A' or 'D').
- After the limit positions have been programmed, the awning can be controlled by simply pressing the appropriate buttons on the control unit. The Up movement will be limited when the awning impacts against the mechanical lock (box) in the Upper limit switch "0". With each impact, the height of this limit switch will be automatically updated by the "Automatic limit switch update" function (paragraph 5.8). Conversely, the Down movement will be limited by the Lower limit switch "1" (limit switch set by the installer at a desired point).

1		2 continues →			
Command an UP movement →				Command an DOWN movement →	
Hold down the button and...		... wait for the awning to be stopped when it collides with the box (= UP limit switch = position "0").	release the button.	Hold down the button and wait...	
→ 2		3		4 → 5	
... release the button as soon as the awning reaches position "1" (DOWN limit switch).		Press and release the button (1 time);		count 2 movements.	
				Hold down the button and	
				release it after 5 seconds ;	
				count 2 movements.	
5		6 end			
Finely adjusting the position of limit switch "1" →					
Press the buttons until you reach the desired position. Alternatively , for more accurate adjustment, run procedure B.1.		Hold down the button and		release it after 5 seconds ;	
				count 3 movements.	

A A.5 - Programming an INTERMEDIATE POSITION (position "H")

NOTES AND WARNINGS

- This procedure memorises an intermediate position (position "H") between the Up ("0") and Down ("1") limit switch positions. When the automation is being used, after giving the **intermediate position** command, the system will automatically stop the awning at the programmed "H" position.
- You can memorise up to 30 "H" positions wherever you wish, provided that these are between the two limit switch positions. These positions can only be programmed after the limit switch positions. Repeat this procedure for each position you wish to memorise.
- The first "H" position must be programmed using the buttons ▲+▼, on the transmitter used to run the procedure itself. However, each subsequent position "H" must be programmed using a button on **another non-memorised transmitter**.
- To change an existing "H" position, move the awning to the desired height and run this procedure; in **step 06**, however, press the button associated with the existing "H" position you are changing.

1	2	3	→ 4
Move the awning to the desired "H" position.	Press and release the button (1 time);	count 2 movements.	Hold down both buttons... release them after 5 seconds;

4	5	6 ...
Press the buttons until you reach the desired position. Alternatively , for more accurate adjustment, run procedure B.1.	Hold down the button and	release it after 5 seconds; count 3 movements.
Select one of the following options and execute it: <ul style="list-style-type: none"> option A – to memorise the <u>FIRST "H" position</u>. option B – to memorise a <u>SUPPLEMENTARY "H" position</u>. 		

6	end
Hold down both buttons... release them after 5 seconds;	count 4 movements.

6	end
On ANOTHER transmitter, which has NOT been memorised: hold down any button you wish;	release it after 5 seconds; count 4 movements.

A A.6 - Memorising ANOTHER TRANSMITTER (second, third, etc.)

NOTES AND WARNINGS





- To run procedures A.6.1.A and A.6.2.A, you must have a **new transmitter** to memorise and an **old previously memorised transmitter**. The two transmitters must have the "PRG" and "ESC" buttons (like "ERA P" and "ERA W" transmitters).
- To run procedures A.6.1.B and A.6.2.B you must have a **new transmitter** to memorise, chosen from the "Nice Screen" catalogue, and an **old previously memorised transmitter**.

A.6.1 - To memorise the transmitter buttons in "Mode I" ("Standard mode")



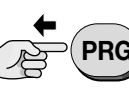
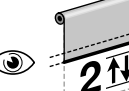

- Procedures A.6.1.A and A.6.1.B memorise all the new transmitter's buttons in "Mode I", with the same configuration as the **old transmitter** (for details about "Mode I" see par. 4.4.1-A).

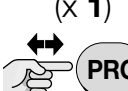
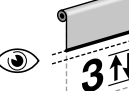
A.6.1.A - Procedure for transmitters equipped with the "PRG" and "ESC" buttons ("ERA P" and "ERA W")

1	→ 2
On the OLD transmitter: hold down the button and	wait ... count 2 movements; wait again... count 2 more movements; release the button.

2			3			end
						
On the NEW transmitter: hold down the button and			release it after 5 seconds ;	count 2 movements.	On the OLD transmitter: press and release the button (1 time);	
				count 3 movements (= transmitter memorised) . If the system makes 6 movements (= memory locked or full, transmitter not memorised).		

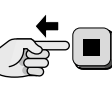









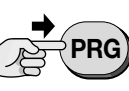
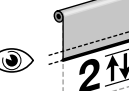

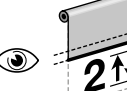
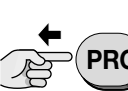
A.6.1.B - Procedure for transmitters without the “PRG” and “ESC” buttons”

1		2		3	
					
On the NEW transmitter: hold down the button and		release it after 8 seconds ;	On the OLD transmitter: press and release the button (3 times), provided the button is memorised.		
			On the NEW transmitter: press and release the button (1 time);		
			count 3 movements (= transmitter memorised) . If the system makes 6 movements (= memory locked or full, transmitter not memorised).		

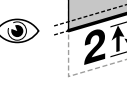
A.6.2 - To memorise the transmitter buttons in “Mode II” (“Custom mode”)

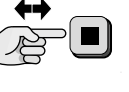

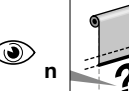
- Procedures A.6.2A and A.6.2.B memorise a single button on the new transmitter in Mode II; i.e. they associate with the button (chosen by the installer) one of the commands in the motor’s “list of commands” (for details on “Mode II” see section 4.4.1-B).
- Procedures A.6.2A and A.6.2.B memorise a single button. Repeat this operation to memorise another button.

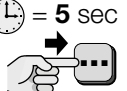
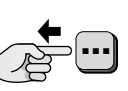
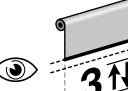
A.6.2.A - Procedure for transmitters equipped with the “PRG” and “ESC” buttons (“ERA P” and “ERA W”)

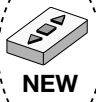
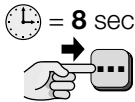
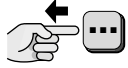
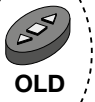
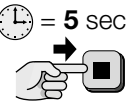

1					2			continues →	
									
On the OLD transmitter: Hold down the button and wait...		count 2 movements;	wait again...	count 2 more movements;	release the button.	On the NEW transmitter: hold down the button and			
						count 3 movements (= transmitter memorised) . If the system makes 6 movements (= memory locked or full, transmitter not memorised).			
→ 2		3			continues →				
		Select the desired option and program it as follows →					8 OPTIONS: 1 press = Open > Stop > Close > Stop > ... 2 presses = Open 3 presses = Close 4 presses = Stop 5 presses = Open after 10 seconds 7 presses = Open after 20 seconds 8 presses = Close after 10 seconds 9 presses = Close after 20 seconds		
release it after 5 seconds ;		count 2 movements.			On the OLD transmitter: Press and release the button the number of times indicated in the option you have chosen;				
→ 3		4			end				
									
After about 7 seconds, the motor performs a number of movements equal to the number of pulses entered.		On the NEW transmitter: select the button you want to memorise; hold it down and			release it after 5 seconds ;		count 3 movements (= transmitter memorised) . If the system makes 6 movements (= memory locked or full, transmitter not memorised).		

A.6.2.B - Procedure for transmitters without the "PRG" and "ESC" buttons

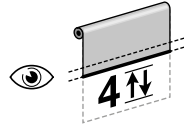
- When performing the procedure, you can cancel the programming at any time by holding down **n** and **t** together for **4 seconds**. Alternatively, do not press any keys and wait 60 seconds for the motor to perform **6 movements**.

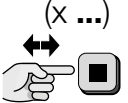
1		2		3		
						
On the NEW transmitter: hold down the button you want to memorise ;		release it after 8 seconds ;	On the OLD transmitter: hold down the button and		release it after 5 seconds ;	count 4 movements .

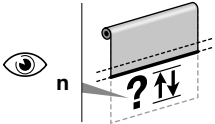

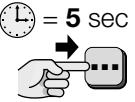
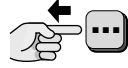
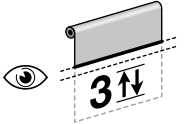
3	continues →	
Select the desired option and program it as follows →		
8 OPTIONS: 1 press = Open > Stop > Close > Stop > ... 2 presses = Open 3 presses = Close 4 presses = Stop 5 presses = Open after 10 seconds 7 presses = Open after 20 seconds 8 presses = Close after 10 seconds 9 presses = Close after 20 seconds		
On the OLD transmitter: press and release the button the number of times indicated in the option you have chosen;		

3	4		end		
					
After about 7 seconds, the motor performs a number of movements equal to the number of pulses entered.		On the NEW transmitter: hold down the same button you pressed in Step 1 ;		release it after 5 seconds ;	count 3 movements (= transmitter memorised) . If the system makes 6 movements (= memory locked or full, transmitter not memorised).

A A.7 - Memorisation of a climate sensor connected via radio

NOTES AND WARNINGS

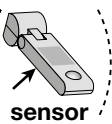
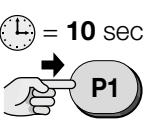
- To run this procedure you need the **climate sensor** you want to memorise, chosen from the "Nice Screen" catalogue, and an **old transmitter** memorised in Mode I (see par. 4.4.1-A).
- When performing the procedure, you can cancel the programming at any time by holding down **n** and **t** together for **4 seconds**. Alternatively, do not press any keys and wait 60 seconds for the motor to perform **6 movements**.

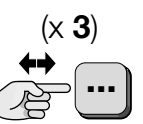
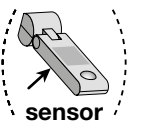
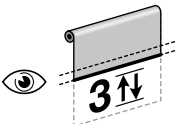
1	2	3	end				
							
On the climate SENSOR: hold down the yellow button "P1" ;		release it after 10 seconds ;	On the OLD transmitter: press and release (3 times) any button.		On the climate sensor: press and release (1 time) the yellow button "P1" ;		count 3 movements (= sensor memorised) . If the system makes 6 movements (= memory locked or full, sensor not memorised).

A A.8 - TOTAL or PARTIAL deletion of memory

NOTES AND WARNINGS

- In order to carry out the following deletion procedures, the transmitter must be memorised in mode I.

A.8.1 - Procedure run with a memorised transmitter

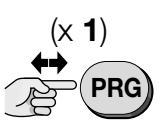
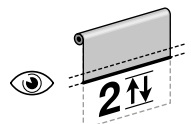
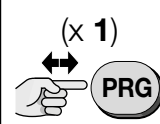
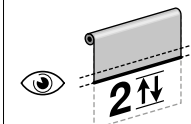
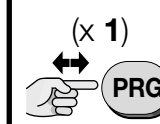
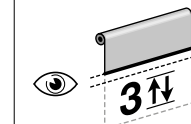
1	2	3	4		
					
Press and release the button (1 time) ;	count 2 movements .	Press and release the button (1 time) ;	count 2 movements .	Press and release the button (1 time) ;	count 3 movements .

4			<p>Select one of the following options and execute it:</p> <ul style="list-style-type: none"> • option A – delete the motor's <u>ENTIRE</u> memory • option B – delete <u>ALL</u> memorised transmitters • option C – delete <u>ONE</u> memorised transmitter • option D – delete <u>ALL</u> positions ("0", "1", "H", etc.). Caution! – This deletion should only be performed if you wish reprogram the distances using a procedure <u>different from the one used previously</u> (e.g. you have used manual distance programming (A.3) and would now like to use the semi-automatic procedure (A.4).
Press and release the button (1 time);	count 4 movements.		

option – A	5			end
	Press and release the button (1 time);	count 5 movements.		

option – B	5				end
	Hold down the button and	release it after 5 seconds ;	count 5 movements.		

option – C	5				end
	Hold down the button and	release it after 5 seconds ;	count 3 movements.		
	6				
		On the transmitter to be deleted: hold down <u>any</u> key either the key memorised in mode 2 or the climatic conditions sensor;			count 5 movements.

option – D	5				end
	Hold down both buttons...	release them after 5 seconds ;	count 5 movements.		

A.8.2 - Procedure run with a transmitter which has not yet been memorised

NOTES AND WARNINGS

- In order to carry out the following procedures, a transmitter with a PRG button should be used.

A.8.2.A - Procedure run with a transmitter which has not yet been memorised and cables for the voltage free contacts

1	2	3	4 ...
			Run procedure A.8.1 in full.
Disconnect the electrical power supply to the motor.	Connect the white and white-black wires together .	Reconnect the electrical power supply to the motor once again.	

A.8.2.B - Procedure run with a transmitter that has not yet been memorised and the limit switch adjustment buttons on the motor head

1	2 ...
On the motor head: hold down both buttons and	release them after 5 seconds ;
	 when the light starts flashing, you have 1 minutes to complete the procedure.
	the red led starts flashing (it turns off when the procedure is completed).
	Run procedure A.8.1 in full.

A A.9 - Assigning a behaviour to a push button panel with 2 buttons

NOTES AND WARNINGS

- Before starting, chose the behaviour from those listed in **Table A**: the choice must account for the mechanical operation of the buttons and the automation application.

Type	Types of behaviour
TYPE A – standard Nice operation for “ERA” series (factory setting). Note – This behaviour is best suited to panels <u>WITH</u> interlocked buttons.	<ul style="list-style-type: none"> • To start a movement: to raise the awning press ▲; to lower it press ▼. • To stop the movement: press <u>the opposite button</u> from that used to start the movement.
TYPE B – with Stop and immediate reverse commands. Note – For this type of operation, use a panel <u>WITH-OUT</u> interlocked buttons.	<ul style="list-style-type: none"> • To start a movement: to raise the awning press ▲; to lower it press ▼. • To stop the movement: press <u>the two buttons together</u>. • To reverse the movement: press <u>the opposite button</u> from that used to start the movement.
TYPE C – with immediate reverse command. Note – This behaviour is best suited to panels <u>WITH</u> interlocked buttons.	<ul style="list-style-type: none"> • To start a movement: to raise the awning press ▲; to lower it press ▼. • To stop the movement: press <u>the same button</u> used to start it. • To reverse the movement: press <u>the opposite button</u> from that used to start the movement.
TYPE D – for hold-to-run commands only. Note – This behaviour is best suited to panels <u>WITH</u> interlocked buttons.	The panel works exclusively in hold-to-run mode: <ul style="list-style-type: none"> • to start the Up movement: hold down button ▲; to stop the movement: release the button. • to start the Down movement: hold down button ▼; to stop the movement: release the button.
TYPE E – logic the same as for “TYPE C” plus intermediate position command. Note – For this type of operation, use a panel <u>WITH-OUT</u> interlocked buttons.	<ul style="list-style-type: none"> • To start a movement: to raise the awning press ▲; to lower it press ▼. • To stop the movement: press <u>the same button</u> used to start it. • To reverse the movement: press <u>the opposite button</u> from that used to start the movement. • To move the awning to the intermediate position (*): press <u>the two buttons together</u>. <p>(*) – If no intermediate position has been programmed, the awning will move to the exact mid-point of its travel.</p>
TYPE F – with Stop command in any situation. Note – This behaviour is best suited to panels <u>WITH</u> interlocked buttons.	<ul style="list-style-type: none"> • To start a movement: to raise the awning press ▲; to lower it press ▼. • To stop the movement: press <u>any button</u>.

1		2		3		→ 4
Press and release the button (1 time);		count 2 movements.		Press and release the button (1 time);		count 2 movements.
				Hold down the button and	release it after 5 seconds ;	
						count 3 movements.

4	continues →
Select the desired option and program it as follows →	<div style="display: flex; justify-content: space-around;"> <div style="text-align: center;"> <p>(X ...)</p> <p>5 OPTIONS:</p> <p>1 press = assign TYPE A.</p> <p>2 presses = assign TYPE B.</p> <p>3 presses = assign TYPE C.</p> <p>4 presses = assign TYPE D.</p> <p>5 presses = assign TYPE E.</p> </div> <div style="text-align: center;"> <p>(X ...)</p> <p>1 OPTION:</p> <p>1 press = assign TYPE F.</p> </div> </div>
Press and release the button (▲ or ▼, according to the option desired) the number of times indicated in the option you have chosen;	

→ 4	5			end
After about 7 seconds, the motor performs a number of movements equal to the number of pulses entered.		Hold down the button and	release it after 5 seconds ;	count 3 movements.

A A.10 - Adjusting the motor's sensitivity to obstacles

NOTES AND WARNINGS

- Use this procedure to activate, adjust or deactivate the safety system that: a) detects the presence of an obstacle along the travel of the awning; b) reduces the motor tension on the awning when it is stationary at the Upper limit switch "0" (only if there is a box or other mechanical stop at this limit switch).
- This procedure adjusts the limit of the traction force that the motor can exert on the awning in an attempt to release it, when it is stopped suddenly by an obstacle or friction. At the same time, if the Upper limit switch "0" is the box or other mechanical stop, the system uses the same value set with this procedure, to reduce the impact of the awning against the box and loosen the tension exerted by the motor on the canvas, when the awning is stationary at the Upper limit switch "0".
- The following options are available:
 - MINIMUM sensitivity** – this setting is only active when the awning is moving Up. The motor delivers a lot of force and will often be able to unjam the awning, even when the load is varying due to friction or small obstacles.
 - ULTRA sensitivity(*)** – this setting is active when the awning is moving Down.
 - ULTRA sensitivity(*) with brief inversion** – this setting is active when the awning is moving Up or Down. If an obstacle is detected when the awning is moving Down, the motor briefly inverts the movement to free it.
 - ULTRA sensitivity(*) with full inversion** – this setting is active when the awning is moving Up or Down. If an obstacle is detected when the awning is moving Up, the motor inverts the movement and stops the awning at the Lowest point "1".
 - sensitivity DISABLED** – this setting disables the safety system (factory setting).

1	2	3	→ 4
 Press and release the button (1 time);	 count 2 movements.	 Press and release the button (1 time);	 Hold down both buttons...
 count 2 movements.	 release them after 5 seconds ;	 count 2 movements.	

4	continues →
Select the desired option and program it as follows →	5 OPTIONS: 1 press = sets MINIMUM sensitivity 2 presses = sets ULTRA sensitivity 3 presses = sets ULTRA sensitivity with short reverse 4 presses = sets ULTRA sensitivity, with reverse 5 presses = sets DISABLED sensitivity
Press and release the button the number of times indicated in the option you have chosen;	

→ 4	5	end
 7 sec.	 1/ 2/ 3/ 4/	 Hold down the button and
After about 7 seconds, the motor performs a number of movements equal to the number of pulses entered.	 release it after 5 seconds ;	 count 3 movements.

(*) – **IMPORTANT** - After having programmed the option, or following the return of power after a blackout, **2 full manoeuvre cycles must be carried out straight away** (Up and Down = 1 cycle) to activate the function. During this movement, the motor maps the instantaneous load along its travel and automatically sets the maximum sensitivity available with the awning in question.

A A.11 - Assigning a command ("Open" or "Step-by-step") to a single button panel

1	2	3	→ 4
 Press and release the button (1 time);	 count 2 movements.	 Press and release the button (1 time);	 count 3 movements.
 Press and release the button (1 time);	 Hold down the button and	 release it after 5 seconds ;	 count 2 movements.
5 ...			
Select one of the following options and execute it:			
<ul style="list-style-type: none"> option A = sets the "OPEN" command. option B = sets the "STEP-BY-STEP" command. 			

option - A	5	end	
	Hold down the button and	release it after 5 seconds ;	count 3 movements.

option - B	5	end	
	Hold down the button and	release it after 5 seconds ;	count 5 movements.

GENERAL INFORMATION ABOUT PROCEDURES “A.12”, “A.13”, “A.14”

The “Cruise speed” (procedure A.12), “Acceleration/deceleration of the movement” (procedure A.13) and “Movement duration” (procedure A.14) functions allow you to completely customise the movement of the awning, allowing you to align multiple awnings of different sizes, with different diameter rollers (among other effects), or make the awning run more quietly.

- The “Movement duration (procedure A.14)” and “Cruise speed (procedure A.12)” functions are interdependent: **the last function to be set determines the awning’s actual cruise speed.**
- After setting the **movement time** (procedure A.14), the system automatically adjusts the **cruise speed** (while accounting for **the acceleration/deceleration** values) to ensure that the movement lasts exactly the set time.
If you then change the **acceleration/deceleration** settings (procedure A.13), or the **limit positions** (procedure A.3 / A.4), the movement duration **remains** unchanged and the system adjusts the **cruise speed** accordingly.
- When setting the **movement duration** (procedure A.14), if the resulting **cruise speed** is outside the allowed range (see the values given in “Technical specifications”), the motor reports the error by moving 6 times at the end of the procedures (A.3 / A.4 / A.13), and automatically restores the **cruise speed** to its nominal value.
- After you have set the **cruise speed with procedure A.14**, changing the **limit positions** (procedure A.3 / A.4) or **acceleration/deceleration** settings (procedure A.13) may set the **cruise speed** outside the allowed range (given in “Technical specifications”). If so, the motor will move 6 times to report the error at the end of the procedures (A.3 / A.4 / A.13), and will automatically restore the nominal **cruise speed**.

A A.12 - Adjusting the awning’s cruise speed

NOTES AND WARNINGS

- For the values of the three options (minimum, nominal and maximum speed), see “Technical characteristics”.
- To determine whether the option chosen for the cruise speed of the awning is compatible with the characteristics of your awning (weight, roller dimensions, torque), refer to “Technical characteristics”.
- The “nominal speed” setting is the factory setting.

1	2	3	4
Press and release the button (1 time);	count 2 movements.	Press and release the button (1 time);	count 2 movements.
Hold down the button and	release it after 5 seconds ;	release it after 5 seconds ;	release it after 5 seconds ;
			count 3 movements.

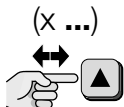
4	continues →
Select the desired option and program it as follows →	 <p>3 OPTIONS: 1 press = sets MINIMUM speed 2 presses = sets NOMINAL speed 3 presses = sets MAXIMUM speed.</p>
	Press and release the button the number of times indicated in the option you have chosen;

→ 4		5			end
After about 7 seconds, the motor performs a number of movements equal to the number of pulses entered.		Hold down the button and	release it after 5 seconds ;	count 3 movements.	

A A.13 - Adjusting the acceleration (at the start of the awning movement) and deceleration (towards the end of the movement)

NOTES AND WARNINGS

- “Acceleration/deceleration” is expressed in roller rotations. This is the number of rotations of the roller the system requires to accelerate from the start of the movement to the cruise speed. It also represents the number of rotations of the roller the system requires to decelerate from cruise speed to stopping at the limit switch.
- The “nominal acceleration/deceleration” setting is the factory setting.

1		2		3 → 4		
Press and release the button (1 time);	count 2 movements.	Press and release the button (1 time);	count 2 movements.	Hold down the button and	release it after 5 seconds ;	count 3 movements.

4			5 continues →			
			Select the desired option and program it as follows →			
Hold down the button and	release it after 5 seconds ;	count 3 movements.			5 OPTIONS: 1 press = sets no acceleration/deceleration = 0 rotations 2 presses = sets brief acceleration/deceleration = 0.7 rotations 3 presses = sets nominal acceleration/deceleration = 1.5 rotations 4 presses = sets long acceleration/deceleration = 2 rotations 5 presses = sets maximum acceleration/deceleration = 3 rotations	
Press and release the button the number of times indicated in the option you have chosen;						

→ 5		6			end
After about 7 seconds, the motor performs a number of movements equal to the number of pulses entered.		Hold down the button and	release it after 5 seconds ;	count 3 movements.	





A A.14 - Adjusting the total duration of the movement

NOTES AND WARNINGS

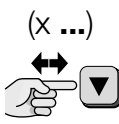
- This adjustment can only be done if the limit switches (“0” and “1”) have already been programmed.
- The value set with this procedure, together with the “acceleration/deceleration” setting (procedure A.13) determines the cruise speed. To determine whether the resulting cruise speed is compatible with the awning (weight, roller dimensions, torque), refer to “Technical characteristics”.
- The factory setting is disabled.

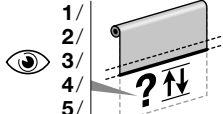
1		2		3 → 4		
Press and release the button (1 time);	count 2 movements.	Press and release the button (1 time);	count 2 movements.	Hold down the button and	release it after 5 seconds ;	count 3 movements.

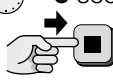

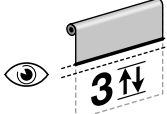

4	continues →
<p>Select the desired option and program it as follows →</p>	<p>(X ...)</p>  <p>5 OPTIONS: 1 press = sets 7 seconds 2 presses = sets 15 seconds 3 presses = sets 20 seconds 4 presses = sets 30 seconds 5 presses = deactivates the function and sets nominal speed</p>
Press and release the button the number of times indicated in the option you have chosen;	

→ 4	5	end		
 7 sec.		 = 5 sec 		
After about 7 seconds, the motor performs a number of movements equal to the number of pulses entered.		Hold down the button and	release it after 5 seconds ;	count 3 movements.

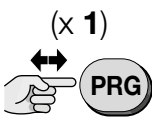
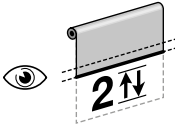
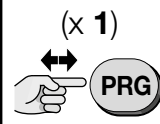
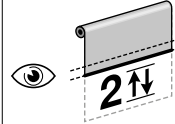

A A.15 - Adjusting the “sun” climate sensor threshold (sensors without on-board trimmer only)

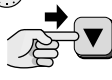
NOTES AND WARNINGS

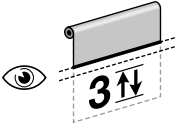
- If the sensor has an on-board trimmer, ignore this procedure and refer to the sensor's instructions for adjusting the threshold directly on the trimmer.
- The product is factory set to a threshold of 15 Klux.

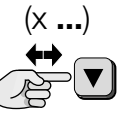
1	2	3	→ 4
<p>(x 1)</p> 		<p>(x 1)</p> 	
Press and release the button (1 time);	count 2 movements.	Press and release the button (1 time);	count 2 movements.
		 = 5 sec 	
		Hold down the button and	release it after 5 seconds ;
			
		count 3 movements.	

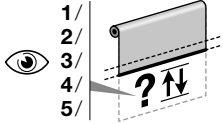
4	continues →
<p>Select the desired option and program it as follows →</p>	<p>(X ...)</p>  <p>5 OPTIONS: 1 press = sets the threshold to 5 Klux 2 presses = sets the threshold to 10 Klux 3 presses = sets the threshold to 15 Klux 4 presses = sets the threshold to 30 Klux 5 presses = sets the threshold to 45 Klux</p>
Press and release the button the number of times indicated in the option you have chosen;	

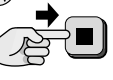
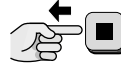
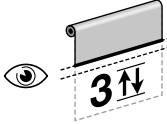
→ 4	5	end		
 7 sec.		 = 5 sec 		
After about 7 seconds, the motor performs a number of movements equal to the number of pulses entered.		Hold down the button and	release it after 5 seconds ;	count 3 movements.

A A.16 - Locking and unlocking the motor's memory

NOTES AND WARNINGS

- Locking the motor's memory stops any other (unscheduled or unauthorised) transmitters being memorised in it.

1		2		3 → 4	
Press and release the button (1 time);	count 2 movements.	Press and release the button (1 time);	count 2 movements.	Press and release the button (1 time);	count 3 movements.

4		5 ...	
			Select one of the following options and execute it: • option A – LOCK motor's memory. • option B – UNLOCK motor's memory.
Hold down both buttons...	release them after 5 seconds;	count 4 movements.	

option – A	5 end	
Hold down the button and	release it after 5 seconds;	count 3 movements.

option – B	5 end	
Hold down the button and	release it after 5 seconds;	count 5 movements.

— GROUP "B" PROCEDURES — Procedures run with the motor head buttons

B B.1 - Precise adjustment of the UP ("0") and DOWN ("1") limit switch positions

NOTES AND WARNINGS

- This adjustment can be done at any time, on condition that the limit switch positions have already been programmed.
- The following procedure describes the setting of the Upper limit switch "0". **To adjust the Lower limit switch "1": (in step 1) command a DOWN movement (rather than UP); (in step 2) adjust the height of limit switch "1" (instead of the height of limit switch "0"); (in step 3) as in the figure below.**

1		2 → 3	
Command an UP movement →		Adjust the position of limit switch "0". →	
Press and release the key.	Wait for the movement to finish at position "0".		Press the buttons until you reach the desired position. Note – Each step of the motor corresponds to a rotation of around 2°.

3 end	
Hold down either of the two buttons;	release it after 5 seconds;
	count 3 movements.

— GROUP “C” PROCEDURES —
only available using a specific programmer (e.g.: TTP)

C NOTES AND WARNINGS

- To run the procedures in this group, you must use a compatible programmer (see the “Nice Screen” catalogue, also available on www.niceforyou.com).
- For the programming and adjustment procedures possible with a given programmer, see the programmer’s user manual and interface.

— GROUP “D” PROCEDURES —

Done with a wall mounted button panel with up and down buttons









GENERAL INFORMATION ABOUT GROUP “D” PROCEDURES

- Group D procedures must be run with a button panel WITHOUT mechanically interlocked, stable buttons.
- The motor should preferably be new, i.e. NOT previously programmed. In any case, the motor MAY NOT have any limit switch positions or transmitters already in memory.
- If the limit switch positions have already been programmed with procedure D.1 and you wish to modify them, you must FIRST delete the old positions with procedure D.2.
- After programming the motor with the Group D procedures, the button panel will work only in hold-to-run mode, with setting “D” from procedure A.9. You will not be able to memorise a transmitter (this will only be possible after having deleted the motor’s memory with procedure D.2).
- To be absolutely sure that the automation’s user cannot inadvertently delete the limit switch positions, install a button panel with interlocked buttons once you have finished programming the unit.

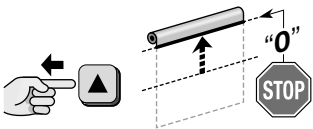
D D.1 - MANUAL programming of the UP (“0”) and DOWN (“1”) limit switches

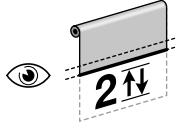
NOTES AND WARNINGS

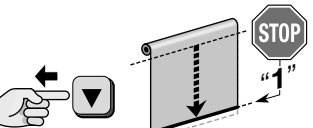
- This procedure must be done with a wall-mounted button panel and can be used instead of procedures A.3.1 and A.3.2, or when you do not wish to use a radio transmitter (or equivalent device) for programming the limit switches.

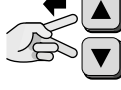
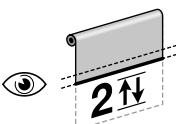
1	→ 3				
<p>Command an UP movement → </p>	<p> ...?...</p>	<p></p>	<p> = 5 sec</p>	<p></p>	<p></p>
Hold down the button ...	wait release the button as soon as the awning reaches the “0” position (UP limit switch) .	Hold down both buttons...	release them after 5 seconds ;	count 2 movements.
3	4				
<p>Command an DOWN movement → </p>	<p> ...?...</p>	<p></p>	<p> = 5 sec</p>	<p></p>	<p></p>
Hold down the button ...	wait ...	release the button as soon as the awning reaches position “1” (DOWN limit switch) .	Hold down both buttons...	release them after 5 seconds ;	count 2 movements.



• Mapping the Up and Down movements to the command buttons (▲ and ▼ respectively)

At the end of this procedure, the awning may be operated by simply pressing the buttons briefly. We recommend moving the awning a few times to ensure that the Up and Down movements are properly mapped to ▲ (up) and ▼ (down). If not, swap around the **white-orange** and **white** wires behind the button panel.

D D.2 - Deleting the ENTIRE memory

NOTES AND WARNINGS

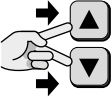
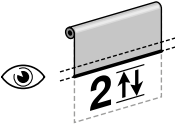
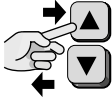
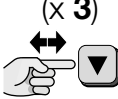
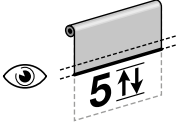
- **Caution!** – This procedure deletes ALL data in the motor's memory, including limit switch positions "0" and "1".

1		2		3 end	
					
Hold down both buttons and	count 2 movements;	immediately release only button ▼; <u>keep holding down</u> button ▲.	Within 5 seconds – Press and release the button (3 times) ;	count 5 movements;	release button ▲.

— GROUP "E" PROCEDURES —

done exclusively with a smartphone with NFC (Near Field Communication)

E NOTES AND WARNINGS

The programming with the "NFC" technology is not yet available on this motor. For more information contact the Nice Technical Assistance.

Using a smartphone equipped with NFC technology and a software application produced by Nice (to be installed on your smartphone), you can configure the motors before installing them, even without the need to supply power. You can also perform a hardware and software diagnostic of the motor, even if it is damaged.

5 WARNINGS FOR NORMAL OPERATION OF THE AUTOMATION

5.1 - Opening, closing and stopping the awning

In general, the awning is operated by pressing the button corresponding to the desired movement: ▲ = open; ▼ = close; ■ = stop. In particular, if using a button panel, refer to the programming done by the installer with procedures A.9 and A.11.

5.2 - Partially opening/closing the awning (height "H")

In general, if a first intermediate position has been programmed, press buttons ▲ and ▼ together to reach it. For the other intermediate positions, refer to the programming done by the installer with procedure A.5. In particular, if using a button panel, the first intermediate position can be commanded only if the installer has set type "E" with procedure A.9.

5.3 - Controlling the awning with a transmitter with multiple groups

If the transmitter controls **multiple groups of screen motors**, before sending a command, select the group to which the motor being programmed belongs. For further information, refer to the transmitter manual.

5.4 - The user can vary the awning speed with a transmitter equipped with a "slider" surface

The awning speed command is given by the user, and is very useful for moving the awning silently (low speed) or more quickly.

If you use a Nice transmitter with "slider" surface (e.g. P1V, etc.) you can vary the speed of the awning as follows: the centre of the slider calls up the speed (100%) set by the installer with procedures A.12 or A.14; the top of the slider moves the awning at 150% of this speed; and the bottom of the slider moves the awning at 33% of the set speed (the speed will in any case be between the Minimum and Maximum speeds permitted by the motor).

5.5 - Enabling/disabling the automatic commands sent to the motor directly by the climate sensors (Table B)

If the automation has climate sensors and the transmitter you are using has buttons ☀ and ☁, you can choose whether to **enable** (with button ☀) or **disable** (with button ☁) reception of the automatic commands sent to the motor by the climate sensors. In brief,

- if reception is enabled (button ☀) the motor will operate **automatically**;
- if reception is disabled (with button ☁) the motor will operate **manually**.

When reception is enabled, the user can send manual commands at any time: these override the automatic operation of the automated device. When reception is disabled, the automated device operates exclusively with the manual commands sent by the user.

— DEFINITIONS —

- **"Over-threshold" intensity of sun/wind** = a condition in which the atmospheric phenomenon stands at values that are **above** the value set as threshold.
- **"Under-threshold" Intensity of sun/wind** = a condition in which the atmospheric phenomenon stands at values ranging **from zero to half** of the value set as threshold.

TABLE B		climate condition...	
		over-threshold	under-threshold
With the motor in "AUTOMATIC" mode (enabled with button ☀) if the user sends the command "Sun-On" (button ☀):	<ul style="list-style-type: none"> • the awning makes 2 movements and remains in the above-threshold position. • the system restarts the timer. 	<ul style="list-style-type: none"> • the awning makes 2 movements and remains in the under-threshold position. • the system restarts the timer.
	... if the user sends the command "Sun-Off" (button ☁):	<ul style="list-style-type: none"> • the awning makes 2 movements. 	<ul style="list-style-type: none"> • the awning makes 2 movements.
With the motor in "MANUAL" mode (enabled with button ☁) if the user sends the command "Sun-On" (with button ☀):	<ul style="list-style-type: none"> • the awning moves to the above-threshold position. • the system restarts the timer. 	<ul style="list-style-type: none"> • the awning moves to the under-threshold position. • the system restarts the timer.
	... if the user sends the command "Sun-Off" (button ☁):	<ul style="list-style-type: none"> • the awning makes 2 movements. 	<ul style="list-style-type: none"> • the awning makes 2 movements.

5.5.1 - Behaviour of the motor in the presence of "Sun" sensor

- When the intensity of the sunlight reaches the over-threshold, after 2 minutes from the beginning of this condition the motor autonomously performs a down movement.
- When the intensity of the sunlight reaches the under-threshold, after 15 minutes from the beginning of this condition the motor autonomously performs an up movement.

Note – Momentary drops in solar intensity, lasting less than 15 minutes, are not detected. The manual commands of the user always remain active and are added to those generated automatically by the system.

5.6 - "Obstacle detection" function

This function is a safety feature which trips automatically when the movement of the awning, up or down, is blocked by an obstacles (physical object, person). The motor immediately stops the movement in progress and performs a brief inversion of the motion (if programmed to do so, see procedure A.10).

5.7 - Reoptimising the limit switch positions

It is normal for limit switch positions to move by a few mm or cm over the days following installation. This may be due to the awning's or frame's material settling or bedding in; this often causes the awning to droop or go out of alignment with nearby awnings. In such cases, if the head of the motor is accessible, you can very easily re-optimize either or both of the limit switch positions with procedure B.1.

5.8 - "Automatic limit switch update" function

Caution! – This function is only available if the limit switches have been programmed with the **Semiautomatic procedure** (par. A.4). This function cannot be disabled.

In ordinary use, the function activates automatically during an Up movement, when the awning collides with the box or other mechanical stop (Up limit switch "0"). On each collision, the function measures the position of the Up limit switch and memorises the new value in place of the previous one. Over time, this compensates for deformations in the structure due to wear and thermal cycles, so that the awning always stops precisely at the Up limit position.

5.9 - Maximum continuous cycle ("thermal protection" function)

The motor is designed for residential use, in other words, for intermittent service. If used continuously for a long time, beyond its rating (see "Technical characteristics"), the system protects the motor against overheating by stopping any further movements until its temperature returns to within the rated limits.

5.10 - Diagnostics and alarm function

On the head of the motor there is a Led that signals the alarm status (with a **red light**) and the installation status (with a **green light**). If it needs to report both at once, the system always gives priority to alarms. For the meanings of the light signals, see **Table C**.

TABLE C – Motor head led signals	
GREEN LED	Meaning
0 flashes	= at least 1 transmitter memorised and 2 limit positions programmed.
1 flash	= at least 1 transmitter memorised and 1 limit position programmed.
2 flashes	= at least 1 transmitter memorised and no limit positions programmed.
3 flashes	= no transmitter memorised (the limit switch status is not shown by the led).
RED LED	Meaning
0 flashes	= no error.
steady on	= serious error - 1 (motor damaged - contact technical service).
1 flash	= thermal protection function in progress.
2 flashes	= the last movement was automatically interrupted by The "Obstacle detection" function.
3 flashes	= load too high relative to motor nameplate rating.
4 flashes	= serious error - 2.
5 flashes	= serious error - 3.
6 flashes	= serious error - 4 (control circuit temperature too high).
7 flashes	= serious error - 5 (brake malfunction).
8 flashes	= serious error - 6 (brake malfunction).
9 flashes	= serious error - 7.
10 flashes	= serious error - 8.
11 flashes	= serious error - 9.

The motor repeats the report message on the status of the installation by performing some brief movements when a movement is commanded. To understand the significance of these movements read **Table D**.

TABLE D – Movement signals	
No. of MOVEMENTS	Meaning
0 movements	= at least 1 transmitter memorised and 2 limit positions programmed.
1 movement	= no transmitter memorised (the limit switch status is not shown by the movements).
2 movements	= at least 1 transmitter memorised and at least 1 limit position still to be programmed.
5 movements	= serious motor memory error.

What to do if... (troubleshooting guide)

In general, to better identify the problem, refer to **Table C** (and **D**), section 5.10.

- ❑ **Powering an electrical phase, the motor does not move:**
After excluding the possibility that thermal protection is active, in which case it is sufficient to wait for the motor to cool down, make sure the mains voltage corresponds to the values indicated in the "technical data" chapter of this manual by measuring the voltage between the "common" wire and the electrical phase wire supplied with current. If the problem is still present, disconnect the power cord from the motor (**fig. 4-i**) and connect it again.
- ❑ **When an Up command is sent, the motor does not start:**
This can happen if the awning is near the Upper limit switch ("0"). In this case you must lower the awning a little bit and give the Raise command again.
- ❑ **The system operates in the emergency condition with an operator present (hold-to-run):**
 - Check to see if the motor has undergone a significant electrical or mechanical shock.
 - Make sure each part of the motor is still in good condition.
 - Delete the UP ("0") and DOWN ("1") limit position and reprogram them.

Disposal of the product

As in installation, also at the end of product lifetime, the disassembly and scrapping operations must be performed by qualified personnel.

This product comprises various types of materials: some may be recycled others must be disposed of. Seek information on the recycling and disposal systems envisaged by the local regulations in your area for this product category. **Caution!** – some parts of the product may contain pollutant or hazardous substances which, if disposed of into the environment, may cause serious damage to the environment or physical health. As indicated by the symbol on the left, disposal of this product in domestic waste is strictly prohibited. Separate the waste into categories for disposal, according to the methods envisaged by current legislation in your area, or return the product to the retailer when purchasing a new version. **Caution!** – Local legislation may envisage serious fines in the event of abusive disposal of this product.



The packing materials of the product must be disposed of in compliance with local regulations.

Technical Characteristics

Refer to the technical characteristics stated on the motor's nameplate.

Note: • All technical specifications stated herein refer to an ambient temperature of 20° C (± 5° C). • Nice S.p.A. reserves the right to apply modifications to products at any time when deemed necessary, maintaining the same intended use and functionality.

EU declaration of conformity

Note: This declaration corresponds to the official declaration held at the registered offices of Nice S.p.a., and in particular to the latest revision available at the time of printing of this manual. The text herein has been adapted for editorial purposes. A copy of the original declaration may be requested from Nice S.p.a. (TV) I.

Declaration number: **537/Era INN Edge I AC**

Revision: **5**

Language: **EN**

Name of manufacturer: NICE S.p.A.

Address: Via Pezza Alta N°13, 31046 Rustignè di Oderzo (TV) Italy

Person authorised to compile the technical documentation: NICE S.p.A.

Type of product: Tubular gearmotor for indoor vertical blinds, darkness blinds and screens for video projection

Model / Type: E EDGE SI 332 AC, E EDGE SI 620 AC, E EDGE SI 1012 AC, E EDGE MI 332 AC, E EDGE MI 632 AC,
E EDGE MI 1020 AC

Accessories: -

The undersigned, Roberto Griffa, in the role of Chief Executive Officer, declares under his sole responsibility, that the product specified above conforms to the provisions of the following directives:

- Directive 2014/53/EU (RED)
- Health protection (art. 3(1)(a)): EN 62479:2010
- Electrical safety (art. 3(1)(a)): EN 60950-1:2006+A11:2009+A12:2011+A1:2010+A2:2013
- Electromagnetic compatibility (art. 3(1)(b)): EN 301 489-1 V2.2.0:2017, EN 301 489-3 V2.1.1:2017
- Radio spectrum (art. 3(2)): EN 300 220-2 V3.1.1:2017

The product also complies with the following standards:

- EN 60335-1:2012+A11:2014
- EN 62233:2008
- EN 60335-2-97:2006+A11:2008+A12:2015+A2:2010
- EN 55014-1:2006+A1:2009+A2:2011; EN 55014-2:2015, EN 61000-3-2:2014, EN 61000-3-3:2013

Oderzo, 12/07/2017

Ing. **Roberto Griffa**
(Chief Executive Officer)

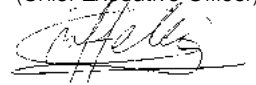



Nice SpA
Via Pezza Alta, 13
31046 Oderzo TV Italy
info@niceforyou.com

www.niceforyou.com