



USER GUIDE

CAPITAL FASCIA

part of Capital Collection



 **MADE IN[®]
BRITAIN**



Fabric: Bexley Jet Set
Capital Fascia: 120 Anthracite

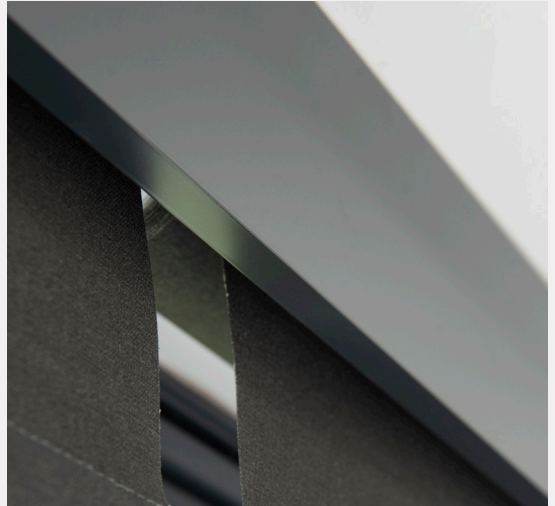



While fashion may be fleeting, style endures.

Capital Fascia offers a modern but timeless touch to any interior window shading, whether in a residential or commercial setting.

Crafted from premium materials, its modular design makes for unbeatable versatility and its six distinct but complementary colours let it integrate into any window.

You can easily tailor it to any window dimensions or configuration, ensuring a cohesive and polished look that will impress even the most discerning of clients.

Finish your shading with style



Capital Fascia configurations

Straight



Straight Return



Right-hand Return



Left-hand Return



Outside Corner



Inverted Corner - Returned



Inverted Corner - Straight



45° Inverted Corner - Straight

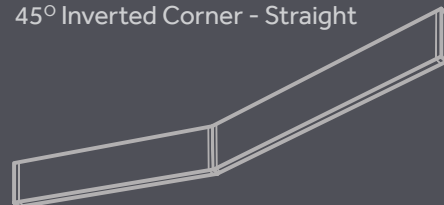

Which fascia size suits my installation?

Both the 90mm and 120mm variants of the Capital Fascia can be recess or face-fixed as required – the freedom you have in positioning your fascia means it can accommodate any blind type and even more than one simultaneously.

So, which is the right height option for your project?

To determine the variant to choose, the total clearance of the blind and its fixing when in a fully open position should be considered. This will be subject to how the blind is fixed, window size and blind type.

For illustration, we are using a simple range of average roller blinds. The roll widths provided are based on a thick roller fabric such as Quad 1% at a drop of 3000mm.

38mm roller tube

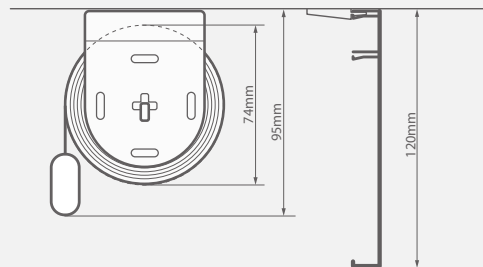
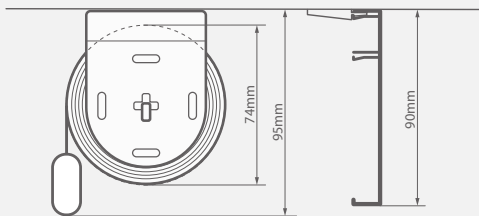

45mm roller tube

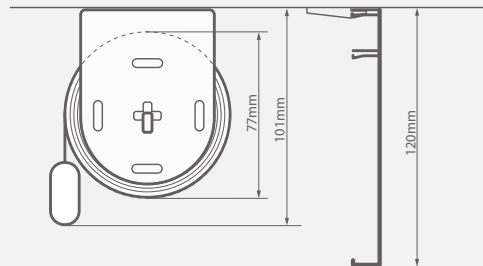
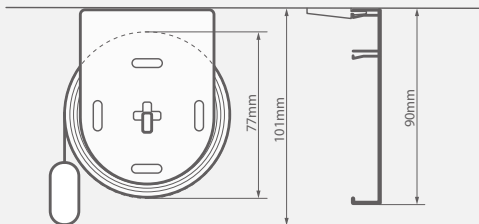

55mm roller tube

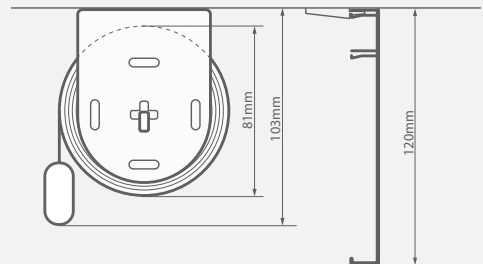
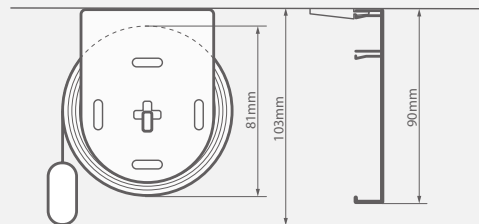

Capital Fascia 90 & 120 components

Fascia Panels

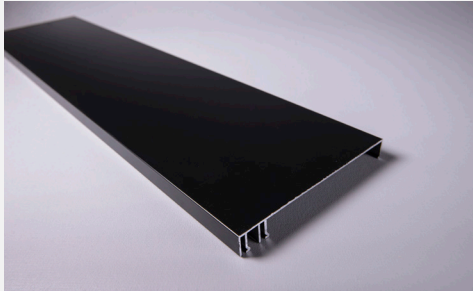

Black

120mm - code **897062**
90mm - code **897114**

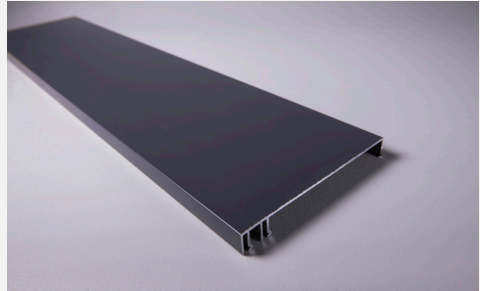

Anthracite

120mm - code **897026**
90mm - code **897086**

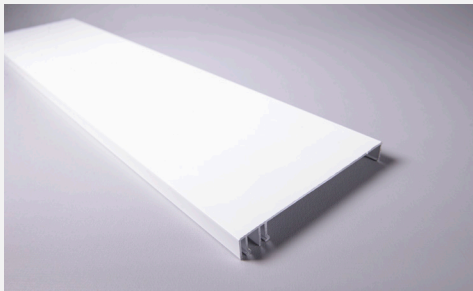

White

120mm - code **897050**
90mm - code **897100**

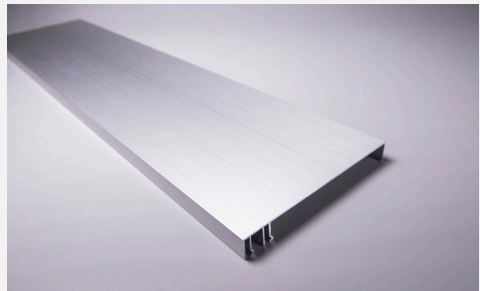

Brushed Silver

120mm - code **897000**
90mm - code **897073**

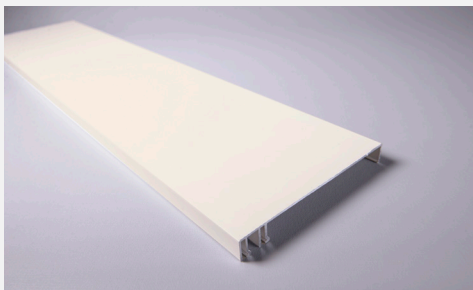

Cream

120mm - code **897038**

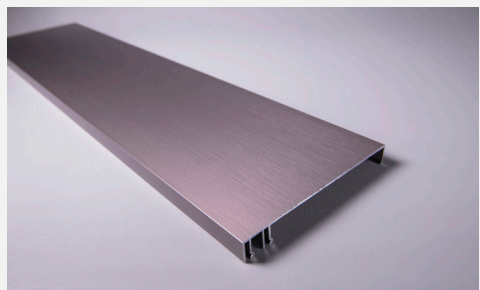

Champagne

120mm - code **897014**

Capital Fascia 90 & 120 components

End Caps

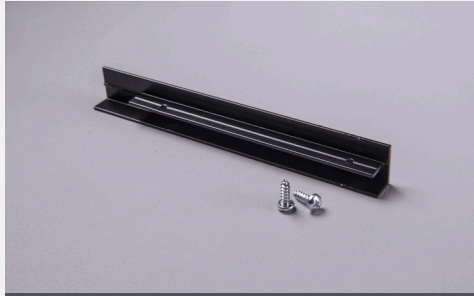

Black Left
120mm - code **897070**
90mm - code **897122**



Black Right
120mm - code **897068**
90mm - code **897120**



Anthracite Left
120mm - code **897034**
90mm - code **897094**



Anthracite Right
120mm - code **897032**
90mm - code **897092**



White Left
120mm - code **897058**
90mm - code **897108**



White Right
120mm - code **897058**
90mm - code **897108**

Capital Fascia 90 & 120 components

End Caps continued



Brushed Silver Left

120mm - code **897008**
90mm - code **897080**



Brushed Silver Right

120mm - code **897006**
90mm - code **897078**



Cream Left

120mm - code **897046**

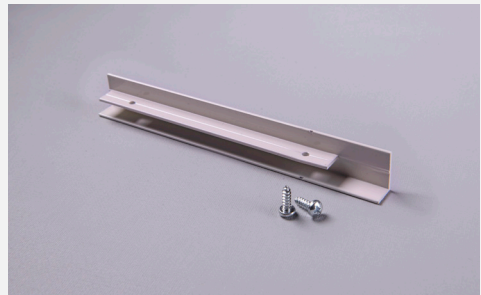

Cream Right

120mm - code **897044**

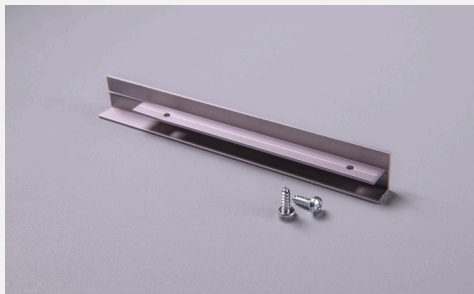

Champagne Left

120mm - code **897046**

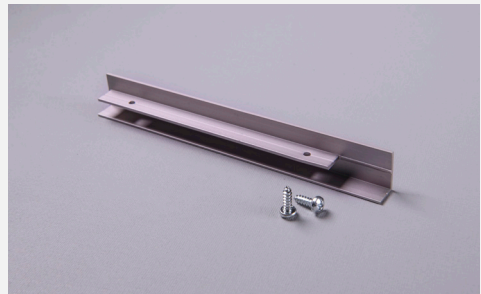

Champagne Right

120mm - code **897046**

Capital Fascia configurations that require End Caps

Straight

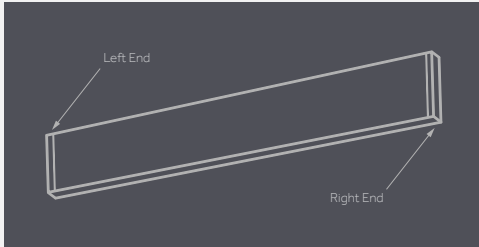

Straight Return

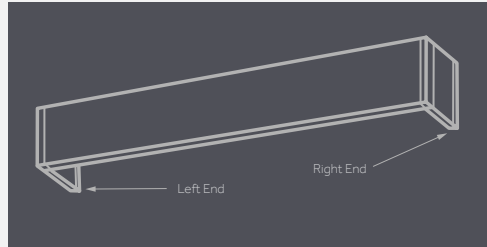

Left-hand Return

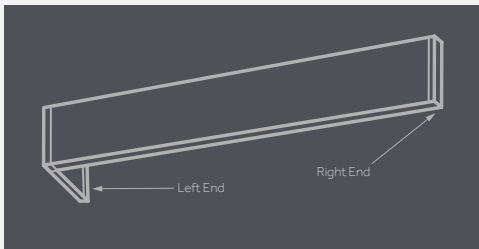

Right-hand Return

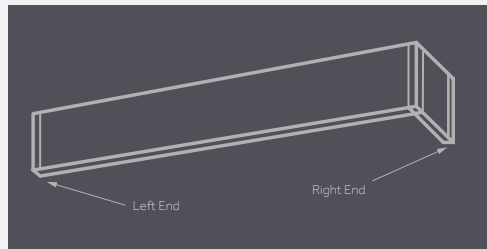

Inverted Corner - Straight

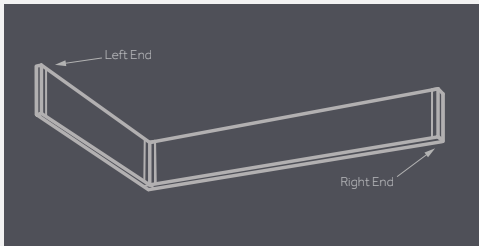

Inverted Corner - Returned

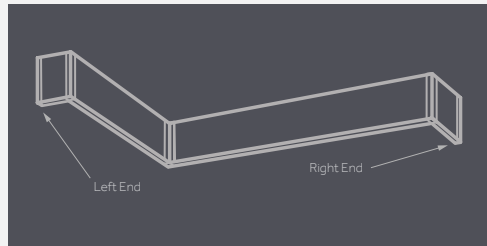

Outside Corner

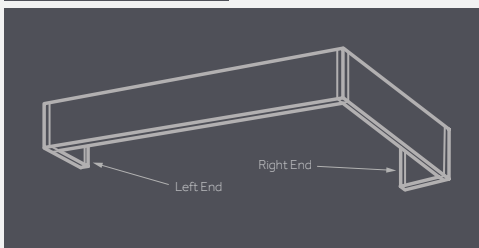

45 Degree Inverted Corner

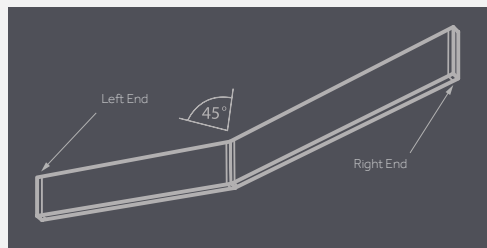

Capital Fascia 90 & 120 components

90° Joiners

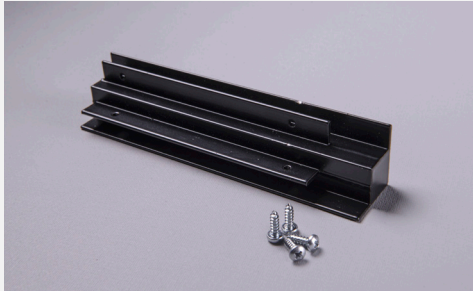

Black

120mm - code **897064**
90mm - code **897116**

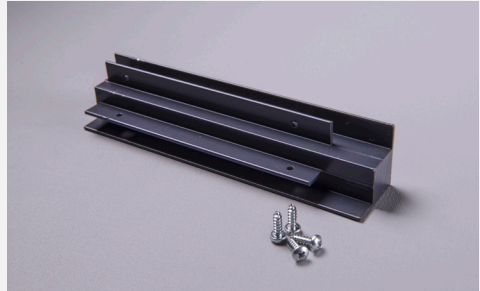

Anthracite

120mm - code **897028**
90mm - code **897088**

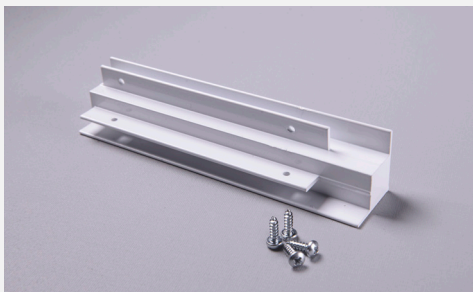

White

120mm - code **897052**
90mm - code **897102**

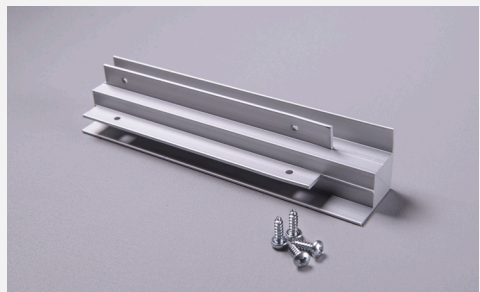

Brushed Silver

120mm - code **897002**
90mm - code **897074**

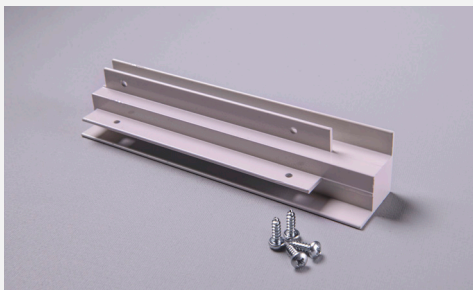

Cream

120mm - code **897040**

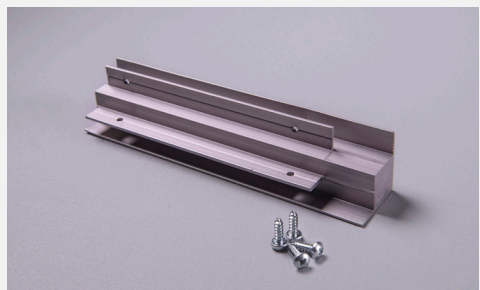

Champagne

120mm - code **897016**

Capital Fascia configurations that require 90° Joiners

Left-hand Return



Right-hand Return



Outside Corner

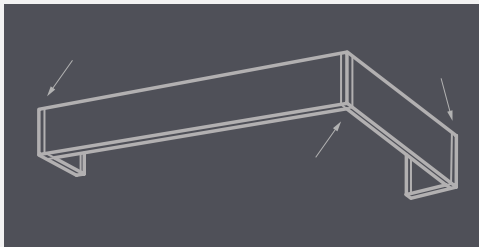

Inverted Corner - Returned

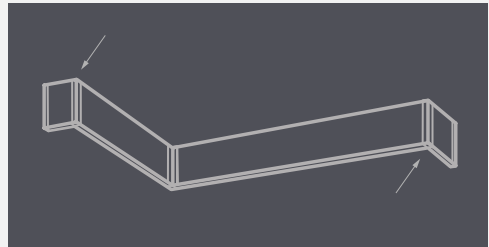

Straight Return

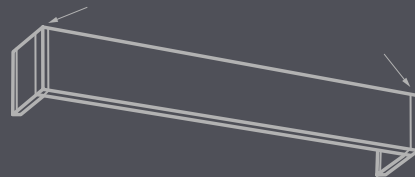

Face-fixing your Capital Fascia

Combine the Top Fix Bracket with a threaded bracket - three sizes available.
See page 22

Capital Fascia 90 & 120 components

90° Inverted Joiners



Black

120mm - code **897066**
90mm - code **897118**



Anthracite

120mm - code **897030**
90mm - code **897090**

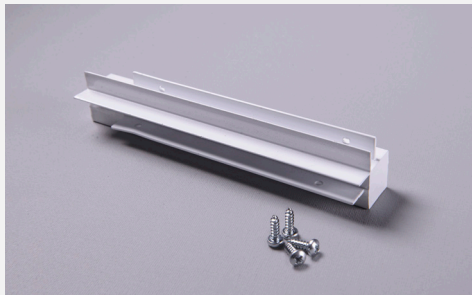

White

120mm - code **897054**
90mm - code **897104**

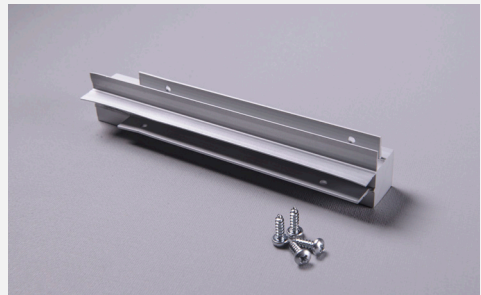

Brushed Silver

120mm - code **897004**
90mm - code **897076**

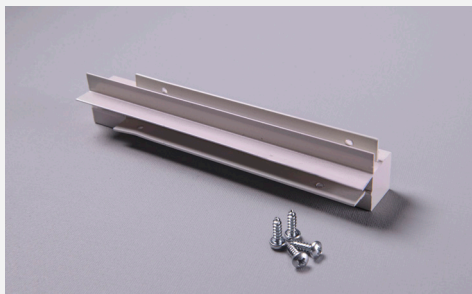

Cream

120mm - code **897042**

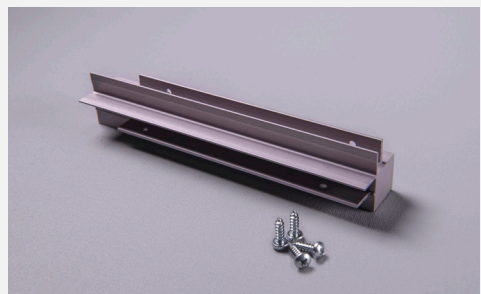

Champagne

120mm - code **897018**

Capital Fascia configurations that require 90° Inverted Joiners

Outside Corner - Straight

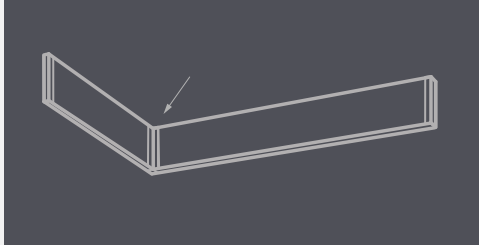

Inverted Corner - Returned

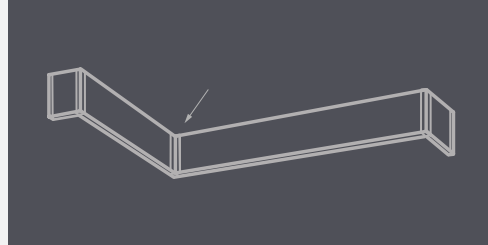

The only limit is your imagination

Capital Fascia's modular design gives you flexibility allowing create a bespoke finish for windows of any size and shape.

Capital Fascia 90 & 120 components

45° Inverted Joiners



Black

120mm - code **897072**
90mm - code **897098**



Anthracite

120mm - code **897037**
90mm - code **897098**

Capital Fascia 90 & 120 components

45° Inverted Joiners continued

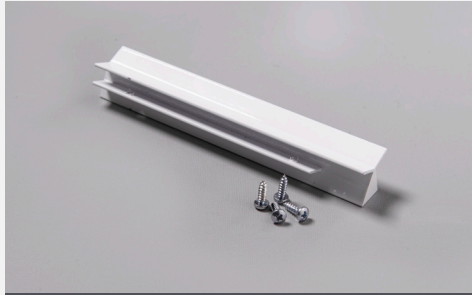

White

120mm - code **897061**
90mm - code **897112**



Brushed Silver

120mm - code **897011**
90mm - code **897084**



Cream

120mm - code **897049**



Champagne

120mm - code **897025**

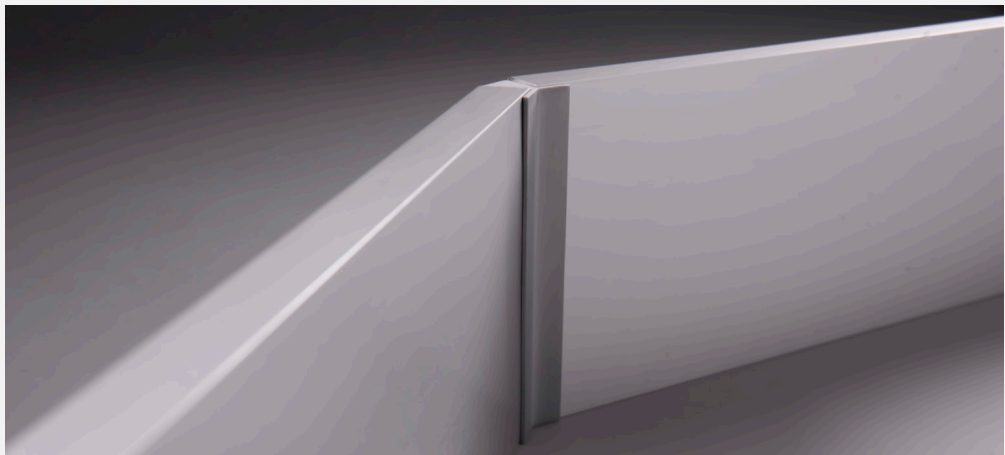

Capital Fascia configurations that require 45° Inverted Joiners

Outside Corner - Straight

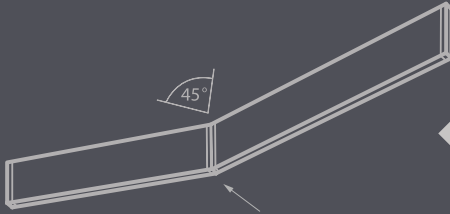

Bay window? We've got you covered.

Combine the fascia with 45-degree joiners and offer a perfect finish for clients with bay windows.

Capital Fascia 90 & 120 components

Straight Joiners



Black

120mm - code **897072**
90mm - code **897124**



Anthracite

120mm - code **897036**
90mm - code **897096**

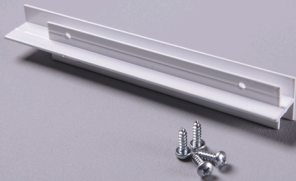

White

120mm - code **897060**
90mm - code **897110**



Brushed Silver

120mm - code **897010**
90mm - code **897082**

Capital Fascia 90 & 120 components

Straight Joiners continued



Capital Fascia configurations that require Straight Joiners

Joined

Join the revolution

Straight Joiners make transportation of fascia panels easy, allowing you to join long lengths on site. Also used to connect full lengths of fascia (max 6m) for wider constructions.

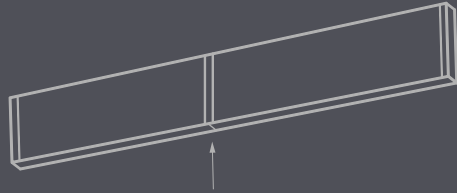

Capital Fascia Side Profile components

Side Profiles



Reduce light leakage in style with the Capital Fascia Side Profile. Positioned behind or in front of a recess-fixed blind, the profile eliminates gaps for complete privacy and greater light control. Fit a matching colour in front of a fascia panel for a clean and cohesive finish. Compatible with all panel options.

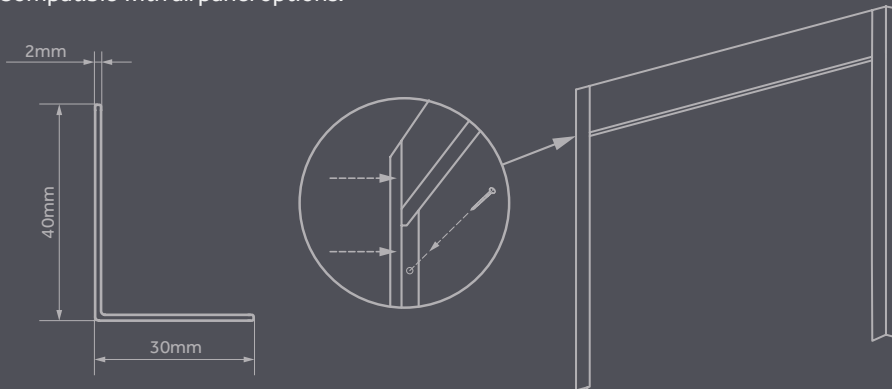

Capital Bottom Bar components

Bottom Bars & End Caps



Black Bottom Bar
code 505101



Black End Cap
code 505105



Anthracite Bottom Bar
code 505100



Anthracite End Cap
code 505104

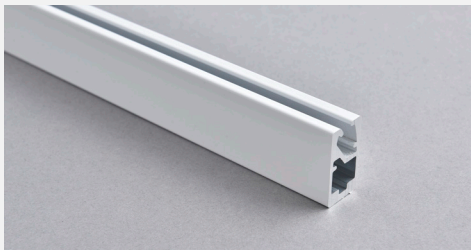

White Bottom Bar
code 505103



White End Cap
code 505107



A blind isn't really a blind without fabric.

Combine Capital Fascia with Capital Collection - our signature collection of fabrics, and build blinds that stand out, providing style, cohesiveness and functionality.

Capital Fascia 90 & 120 components

Brackets

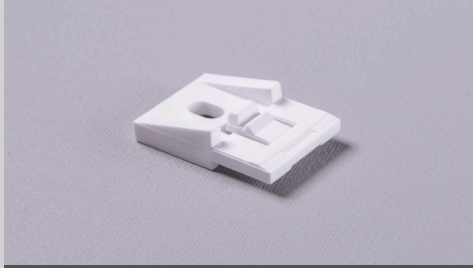

Top Fix Bracket

White - code 897012
Black - code 897013



Threaded Brackets

65mm - code 181000
95mm - code 181010
125mm - code 181020

Top-fix fitting

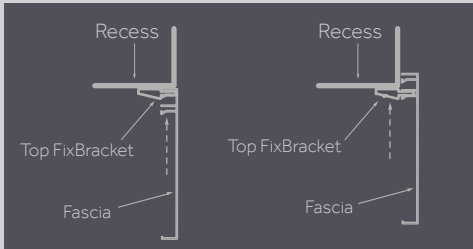

Face-fix fitting

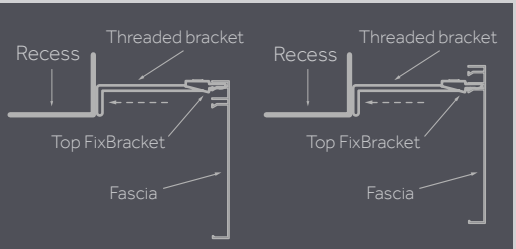

Face-fix bracket assembly

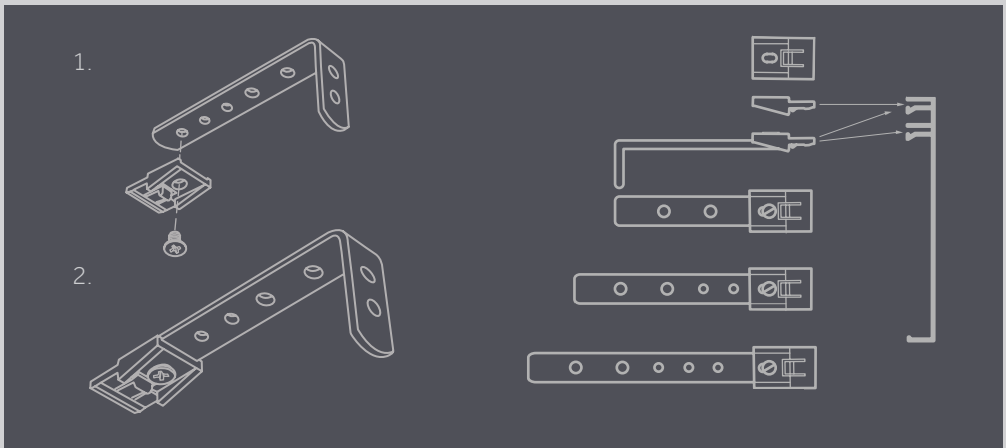

Return projection dimensions for face-fix fitting

