

MORVELLE<sup>2</sup>

# Bioclimatic Pergola

British made



An aerial photograph of a modern outdoor patio. The patio is paved with light-colored square tiles and features a large pergola with a white slatted roof and dark grey metal posts. Under the pergola, there is a blue and white striped sofa, a dark blue coffee table with a tray of food, and a small wooden side table. The patio is surrounded by lush greenery, including trees and a brick wall. The text "Your outdoors, your way" is overlaid in white in the center of the image.

Your outdoors, your way

# Designed for every British season

## Carefully crafted



For over two years, our R&D team worked to develop a system that can not only withstand the elements but can be custom-made specifically for your garden, occupying as much or as little space as you'd like.

## 10 year-warranty



Using the highest grade 6063-T6 aluminium, premium quality is guaranteed. Powder-coated to Qualicoat's industry standard, we provide a 10-year warranty with every pergola. Motor and electrical parts are also covered with a 2-year manufacturer's warranty.

## British made

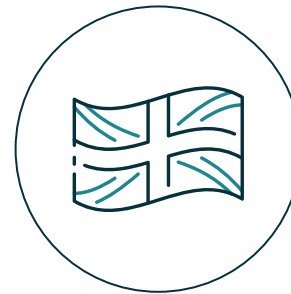

We are the first and only British manufacturer of bioclimatic pergolas, and extremely proud of it. From our 13,000 ft production facility in Hampshire, your pergola will be precision-made to make the most of your space and wow for years to come.

## 4 week lead time



No one does it quite like us. The fastest in the industry, our dedicated 2-person delivery service will ensure your delivery is stress-free, as well as fast.





# Find more time in your day

There are only 24 hours in the day, but a Morvelle bioclimatic pergola will make each hour more meaningful. Transform your evening social events, or enjoy an early morning sunrise from your own personal outdoors.

# Forget the forecast

It's time to stop letting the weather change your plans and spoil the fun. Your louvred roof turns your pergola into an all-weather shelter, letting the party go on as long as you'd like. It uses a built-in trough to collect rainwater and disperse it with minimal impact on your garden.



# Optional extras

## Sliding or fixed glass panels

Maintain natural daylight levels whilst protecting from low temperatures and wet afternoons. Morvelle doors are made from 8mm toughened safety glass, with both 3, 5, 6 or 10 door systems available depending on your requirements.

We can also fit a fixed frame with laminated safety glass panels, and aluminium panels that offer enhanced privacy for your garden or protection from unsightly fences and bushes.



## Zip screen blinds

Either manual or motorised, our zip screen blinds offer protection from the sun, additional shade and privacy in your personal outdoors.

Housed inside an aluminium cassette, the exterior grade mesh fabric is attached via zip, keeping the fabric taut at all times - both functional and aesthetic. When not in use, they can be retracted and completely hidden from view.



## 1. LED Lighting

A continuous 24V LED strip offers warm white light, housed within the gutter profile and running around the entire perimeter of the bioclimatic pergola. Dim and brighten the light as you please via the handheld remote.



## 2. Motor

A 24V motor is concealed inside the perimeter beam and rotates the louvres open and closed. Stop the louvres in any position with ease via the handheld remote.



## 3. Drainage

Rainwater is collected in the louvres and drains into the perimeter gutter. Entirely concealed, a downpipe disperses the water at ground level through a slot at the bottom of the post.



## 4. Louvres

The louvres are made from a single extrusion with a central reinforcing wall for enhanced strength. The louvres can rotate 110 degrees to remain as open or closed as required.



## 5. Patent Pending Louvre Fixing

The louvres are fixed in place by our patent pending 'click-fit' mechanism. This makes installation fast, whilst ensuring services and repairs are simple to undertake when required.

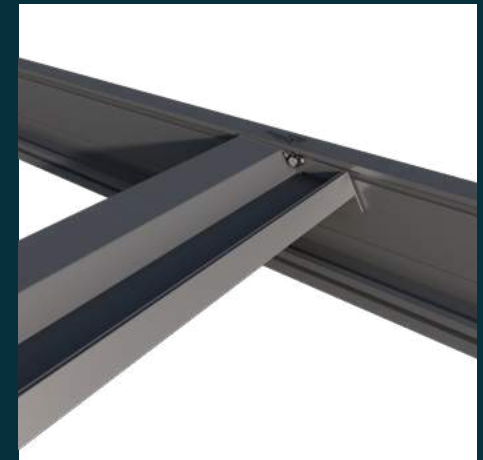

## 6. Base Plates

We offer an option of surface-mounted or concealed base plates, depending on your needs. Concealed base plates can be adjusted to suit foundations that aren't quite level.



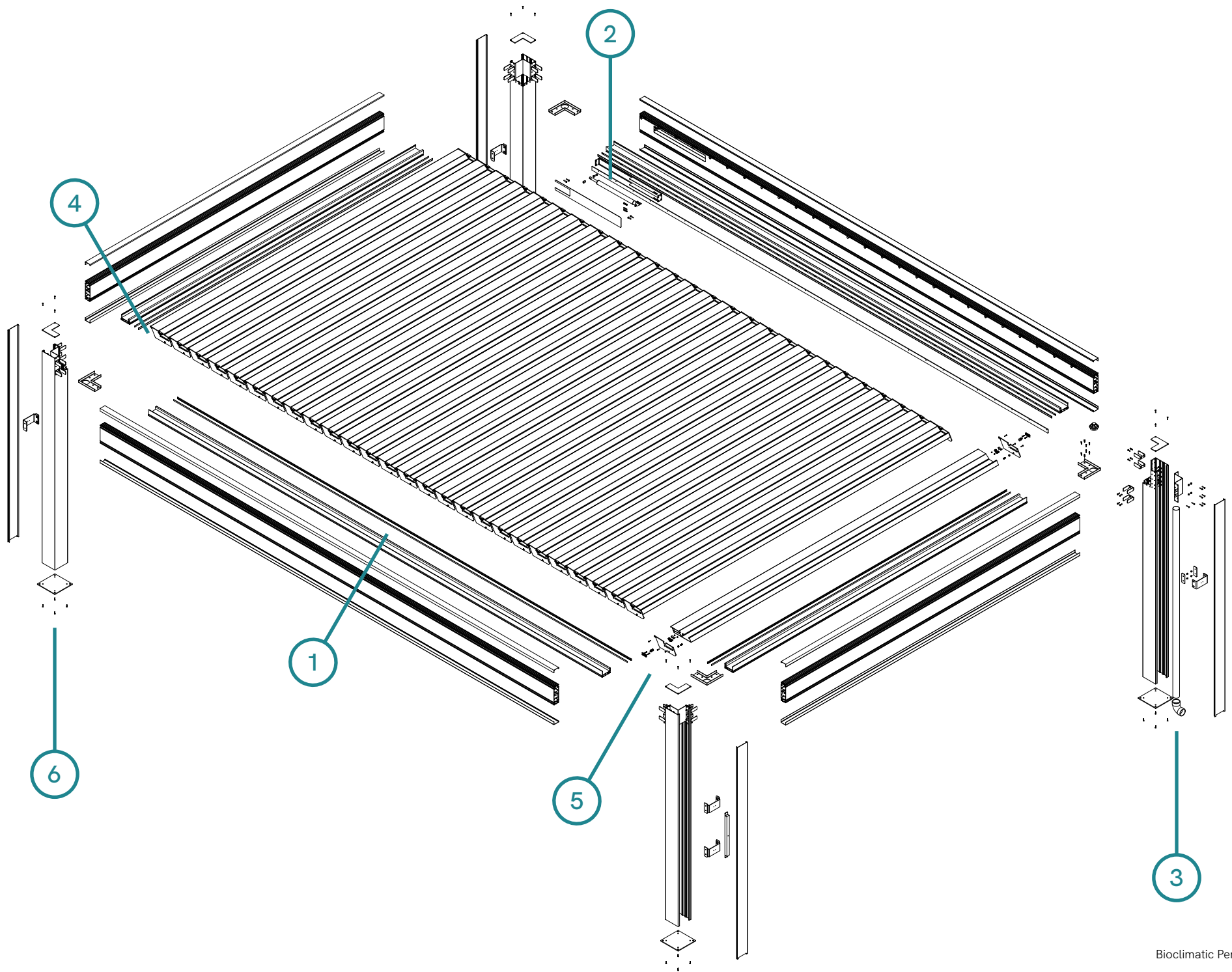

## Size Parameters

EN13561 Wind Class 6 Rated  
Snow Zone 3 Rated

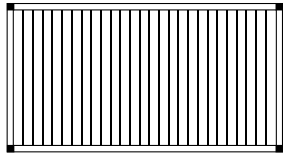

Length  
6m max

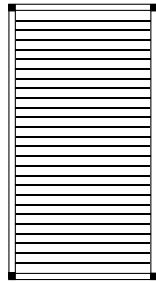

Width  
4.5m max

## Configurations

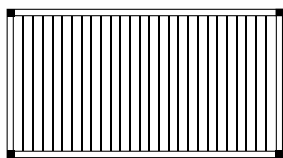

Stand alone

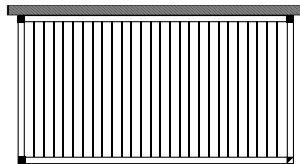

Fixed to wall

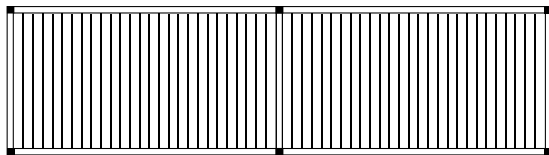

End-to-end

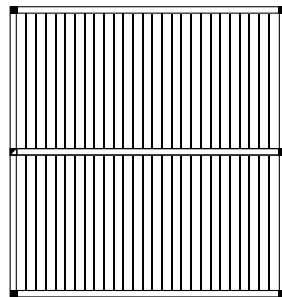

Side to side

## Colour Options

Our standard colour is RAL 7016 Anthracite Grey (matt textured). However we can paint to any RAL colour for a small extra cost (below is a small selection of the most popular). It's possible to mix and match colours by having the louvres a different colour to the frame.

7016	9005	9011	7021	7011
7043	7015	7005	7023	9007
7031	7001	7022	6009	6003
6011	7010	7033	8017	8029
3003	2007	1019	7048	7038
7032	9002	7047	9010	9016



Proudly designed and made in Britain