



# **USER GUIDE**

## **CAPITAL FASCIA**

part of Capital Collection



 **MADE IN<sup>®</sup>  
BRITAIN**



**Fabric:** Bexley Jet Set  
**Capital Fascia:** 120 Anthracite





**While fashion may be fleeting, style endures.**

Capital Fascia offers a modern but timeless touch to any interior window shading, whether in a residential or commercial setting.

Crafted from premium materials, its modular design makes for unbeatable versatility and its six distinct but complementary colours let it integrate into any window.

You can easily tailor it to any window dimensions or configuration, ensuring a cohesive and polished look that will impress even the most discerning of clients.

**Finish your shading with style**



# Capital Fascia configurations

Straight



Straight Return



Right-hand Return



Left-hand Return



Outside Corner

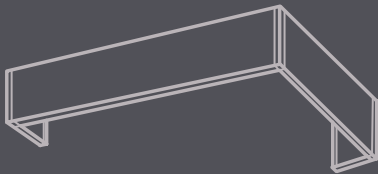

Inverted Corner - Returned



Inverted Corner - Straight



45° Inverted Corner - Straight

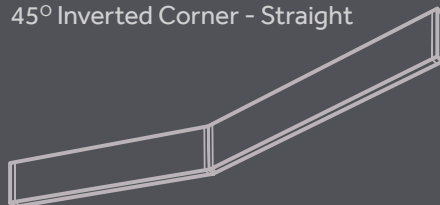

## Which fascia size suits my installation?

Both the 90mm and 120mm variants of the Capital Fascia can be recess or face-fixed as required – the freedom you have in positioning your fascia means it can accommodate any blind type and even more than one simultaneously.

So, which is the right height option for your project?

To determine the variant to choose, the total clearance of the blind and its fixing when in a fully open position should be considered. This will be subject to how the blind is fixed, window size and blind type.

For illustration, we are using a simple range of average roller blinds. The roll widths provided are based on a thick roller fabric such as Quad 1% at a drop of 3000mm.

### 38mm roller tube

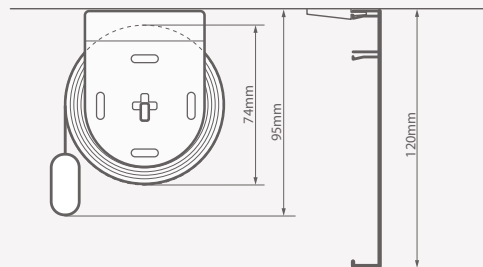
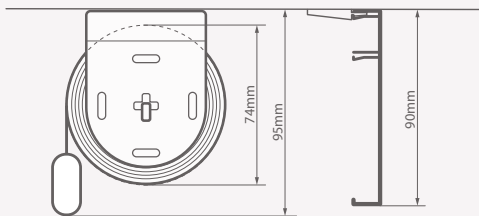

### 45mm roller tube

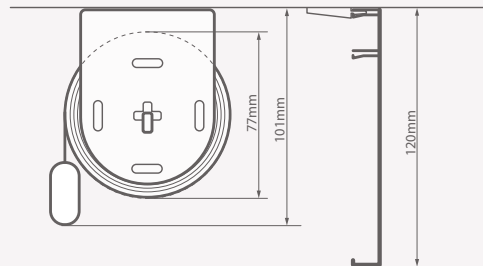
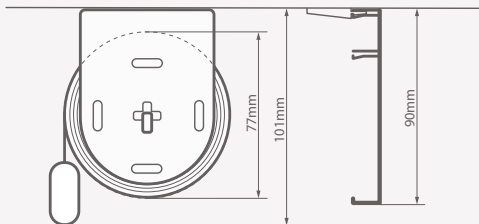

### 55mm roller tube

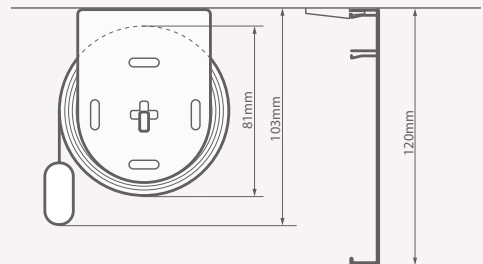
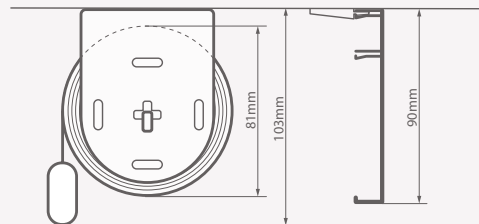

## Capital Fascia 90 & 120 components

### Fascia Panels



#### Black

120mm - code **897062**  
90mm - code **897114**



#### Anthracite

120mm - code **897026**  
90mm - code **897086**



#### White

120mm - code **897050**  
90mm - code **897100**



#### Brushed Silver

120mm - code **897000**  
90mm - code **897073**



#### Cream

120mm - code **897038**



#### Champagne

120mm - code **897014**

## Capital Fascia 90 & 120 components

### End Caps



**Black Left**  
120mm - code **897070**  
90mm - code **897122**



**Black Right**  
120mm - code **897068**  
90mm - code **897120**



**Anthracite Left**  
120mm - code **897034**  
90mm - code **897094**



**Anthracite Right**  
120mm - code **897032**  
90mm - code **897092**



**White Left**  
120mm - code **897058**  
90mm - code **897108**



**White Right**  
120mm - code **897058**  
90mm - code **897108**

## Capital Fascia 90 & 120 components

### End Caps continued



**Brushed Silver Left**

120mm - code **897008**  
90mm - code **897080**



**Brushed Silver Right**

120mm - code **897006**  
90mm - code **897078**



**Cream Left**

120mm - code **897046**



**Cream Right**

120mm - code **897044**



**Champagne Left**

120mm - code **897046**



**Champagne Right**

120mm - code **897046**

# Capital Fascia configurations that require End Caps

Straight

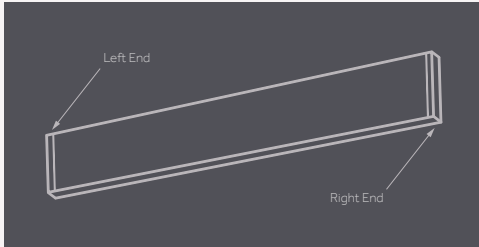

Straight Return

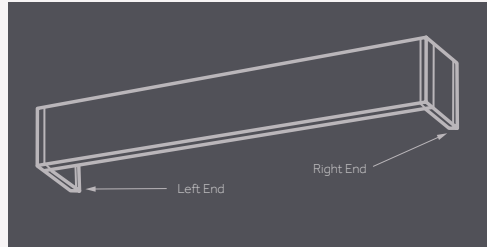

Left-hand Return

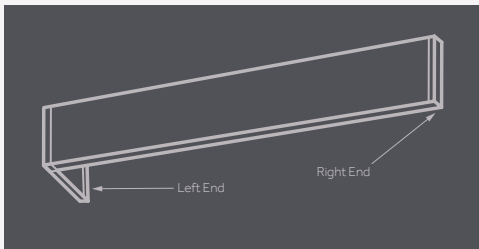

Right-hand Return

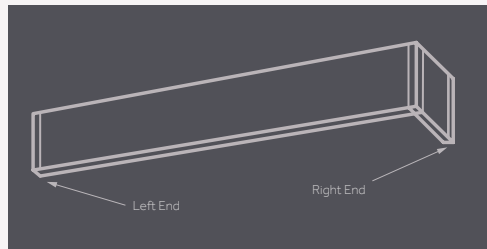

Inverted Corner - Straight

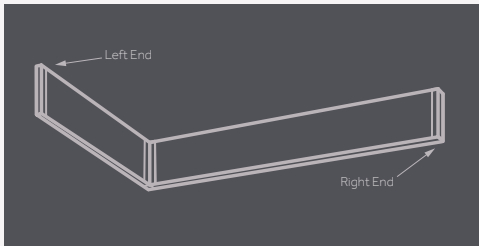

Inverted Corner - Returned

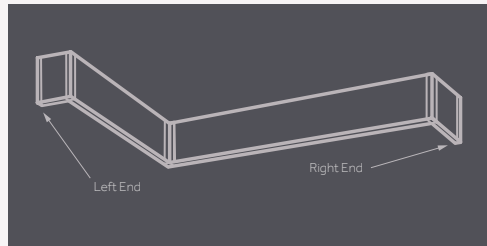

Outside Corner

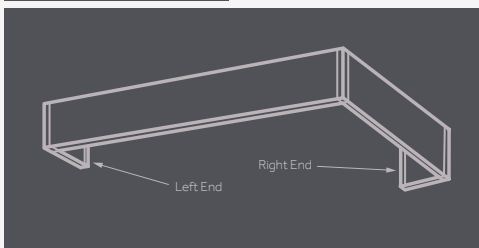

45 Degree Inverted Corner

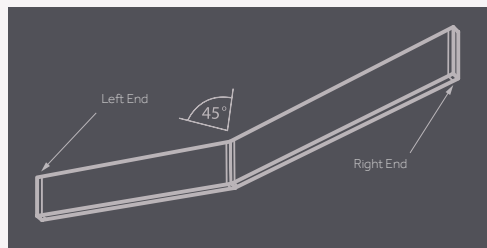

## Capital Fascia 90 & 120 components

### 90° Joiners



#### Black

120mm - code **897064**  
90mm - code **897116**

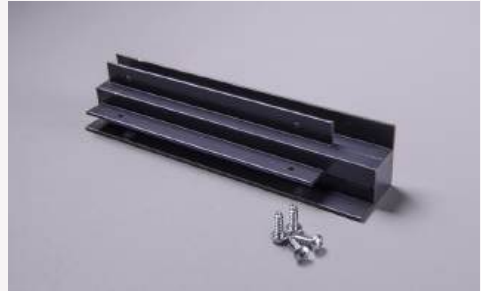

#### Anthracite

120mm - code **897028**  
90mm - code **897088**



#### White

120mm - code **897052**  
90mm - code **897102**



#### Brushed Silver

120mm - code **897002**  
90mm - code **897074**

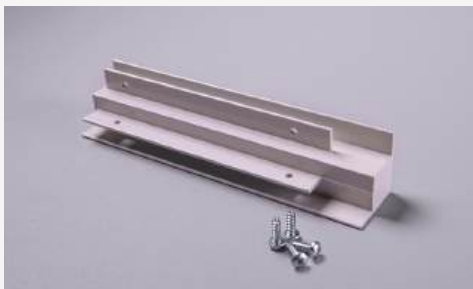

#### Cream

120mm - code **897040**

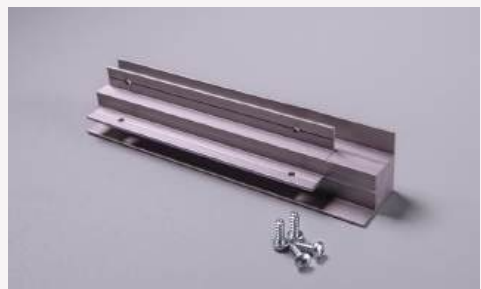

#### Champagne

120mm - code **897016**

# Capital Fascia configurations that require 90° Joiners

Left-hand Return



Right-hand Return



Outside Corner

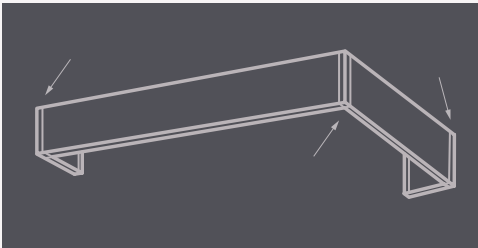

Inverted Corner - Returned

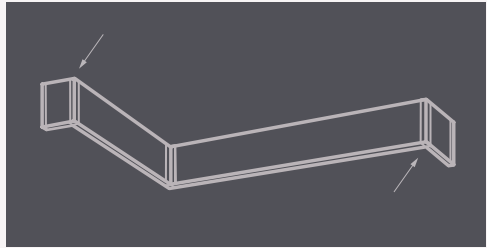

Straight Return

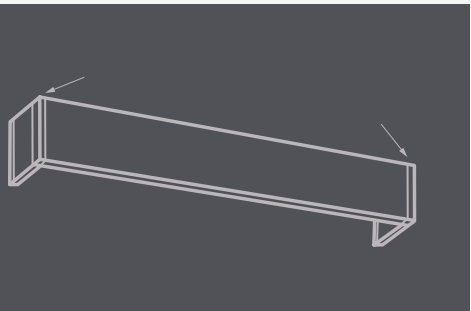

## Face-fixing your Capital Fascia

Combine the Top Fix Bracket with a threaded bracket - three sizes available.  
See page 22

## Capital Fascia 90 & 120 components

### 90° Inverted Joiners



**Black**

120mm - code **897066**  
90mm - code **897118**



**Anthracite**

120mm - code **897030**  
90mm - code **897090**



**White**

120mm - code **897054**  
90mm - code **897104**



**Brushed Silver**

120mm - code **897004**  
90mm - code **897076**



**Cream**

120mm - code **897042**



**Champagne**

120mm - code **897018**

# Capital Fascia configurations that require 90° Inverted Joiners

Outside Corner - Straight

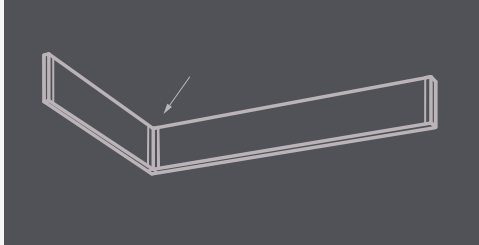

Inverted Corner - Returned

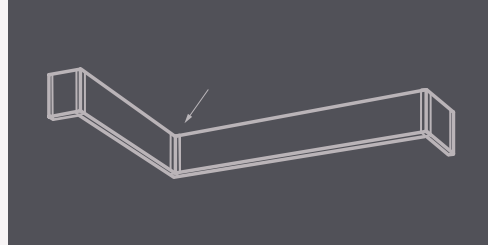

**The only limit is your imagination**

Capital Fascia's modular design gives you flexibility allowing create a bespoke finish for windows of any size and shape.

Capital Fascia 90 & 120 components

## 45° Inverted Joiners



**Black**

120mm - code **897072**  
90mm - code **897098**



**Anthracite**

120mm - code **897037**  
90mm - code **897098**

## Capital Fascia 90 & 120 components

### 45° Inverted Joiners continued



#### White

120mm - code **897061**  
90mm - code **897112**



#### Brushed Silver

120mm - code **897011**  
90mm - code **897084**



#### Cream

120mm - code **897049**



#### Champagne

120mm - code **897025**

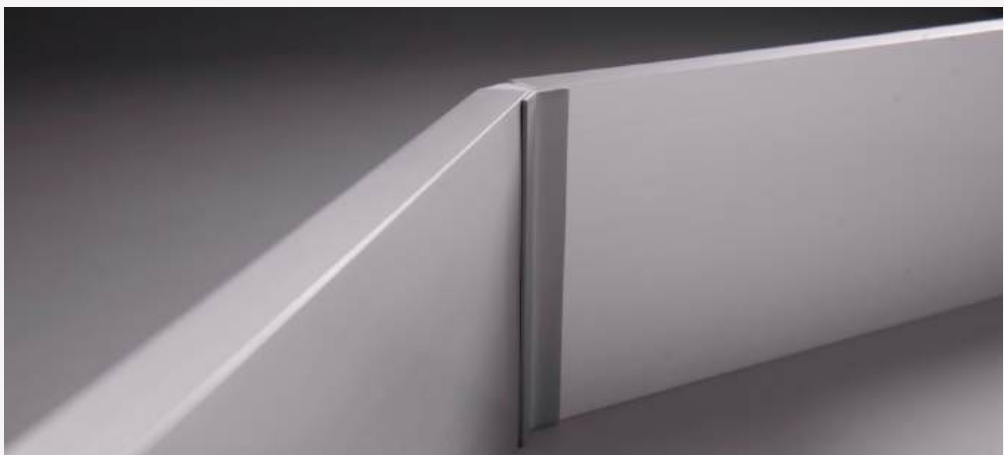

# Capital Fascia configurations that require 45° Inverted Joiners

## Outside Corner - Straight

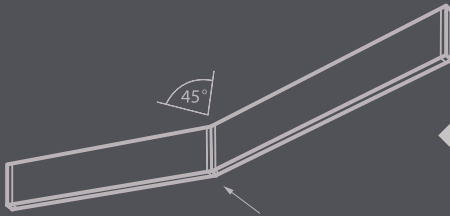

### Bay window? We've got you covered.

Combine the fascia with 45-degree joiners and offer a perfect finish for clients with bay windows.

## Capital Fascia 90 & 120 components

### Straight Joiners



#### Black

120mm - code **897072**  
90mm - code **897124**



#### Anthracite

120mm - code **897036**  
90mm - code **897096**



#### White

120mm - code **897060**  
90mm - code **897110**



#### Brushed Silver

120mm - code **897010**  
90mm - code **897082**

## Capital Fascia 90 & 120 components

### Straight Joiners continued



**Cream**  
120mm - code 897048



**Champagne**  
120mm - code 897024

## Capital Fascia configurations that require Straight Joiners

Joined

### Join the revolution

Straight Joiners make transportation of fascia panels easy, allowing you to join long lengths on site. Also used to connect full lengths of fascia (max 6m) for wider constructions.

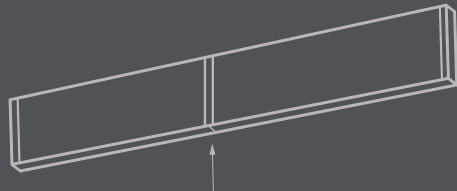

## Capital Fascia Side Profile components

### Side Profiles



Reduce light leakage in style with the Capital Fascia Side Profile. Positioned behind or in front of a recess-fixed blind, the profile eliminates gaps for complete privacy and greater light control. Fit a matching colour in front of a fascia panel for a clean and cohesive finish. Compatible with all panel options.

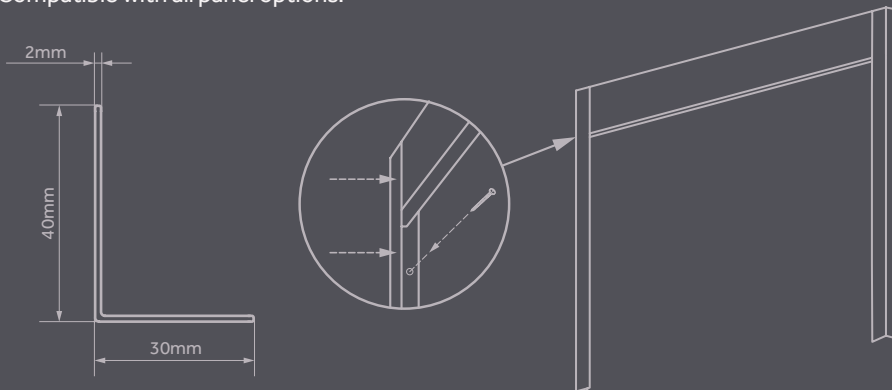

## Capital Bottom Bar components

### Bottom Bars & End Caps



**Black Bottom Bar**  
code 505101



**Black End Cap**  
code 505105



**Anthracite Bottom Bar**  
code 505100



**Anthracite End Cap**  
code 505104



**White Bottom Bar**  
code 505103



**White End Cap**  
code 505107



**A blind isn't really a blind without fabric.**

Combine Capital Fascia with Capital Collection - our signature collection of fabrics, and build blinds that stand out, providing style, cohesiveness and functionality.

# Capital Fascia 90 & 120 components

## Brackets



### Top Fix Bracket

White - code 897012  
Black - code 897013



### Threaded Brackets

65mm - code 181000  
95mm - code 181010  
125mm - code 181020

### Top-fix fitting

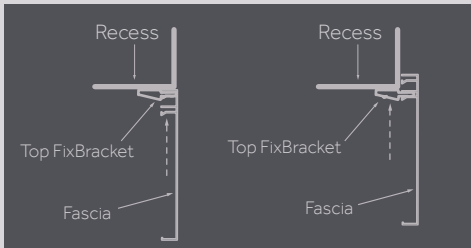

### Face-fix fitting

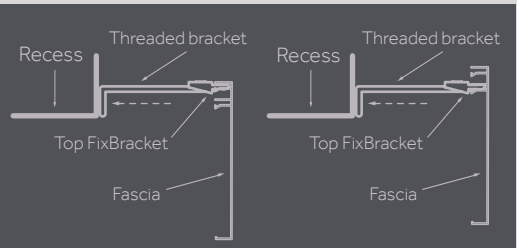

### Face-fix bracket assembly

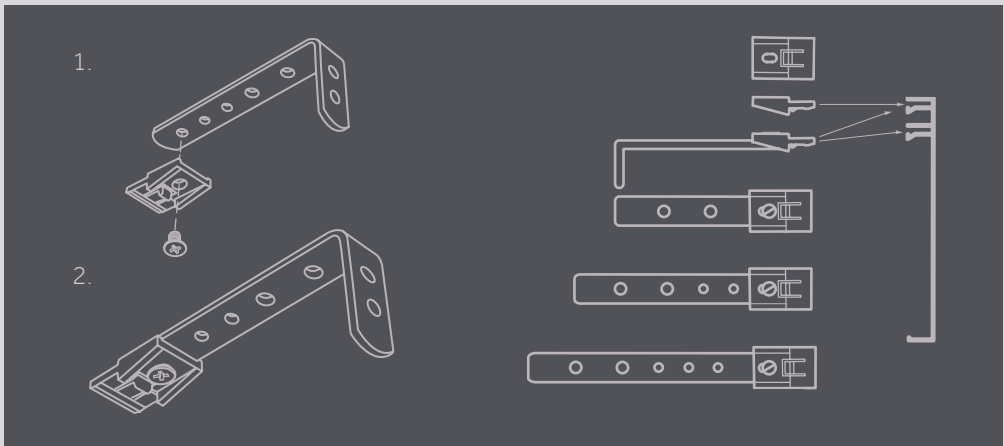

## Return projection dimensions for face-fix fitting

