

9

9

NOTES:

Shutter Color: Timeless White(覆盖色)

Hinges Color: White(白色)

Qty(数量): 1

Material(材质): Paulownia(桐木)

Configuration(窗扇结构): R,IN, 4Side, 41.3mm Butt, Deep Plain L Frame 60mm

Tilt rod type(拉杆类型): Easy tilt rod(齿条拉杆)

Louvre Quantity(叶片数量): 18

Louvre Size(叶片尺寸): 602mm

Rail Size(上下板尺寸): 654mm

Order No(订单号): BAI G361575 MCGOWAN

Item(序号): 1

Room(房间号): LOUNGE 1

Louvre Size(叶片类型): 76mm

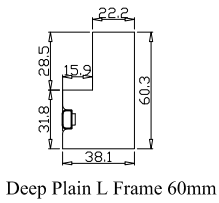

Deep Plain L Frame 60mm

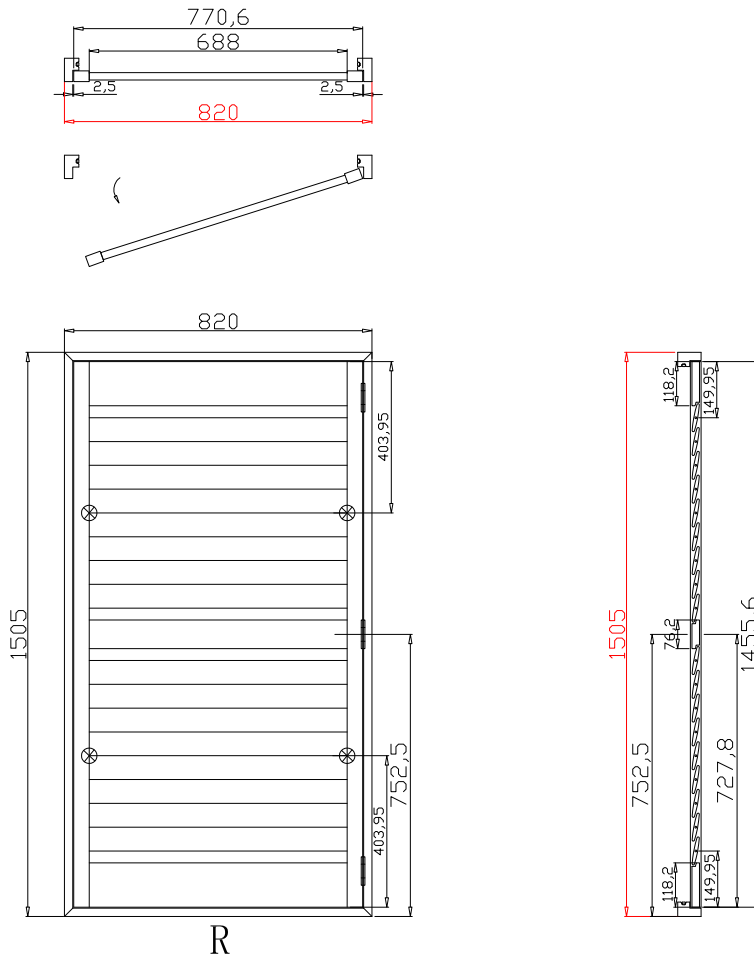

9

9

NOTES:

Shutter Color: Timeless White(覆盖色)

Hinges Color: White(白色)

Qty(数量): 1

Material(材质): Paulownia(桐木)

Configuration(窗扇结构): R,IN, 4Side, 41.3mm Butt, Deep Plain L Frame 60mm

Tilt rod type(拉杆类型): Easy tilt rod(齿条拉杆)

Louvre Quantity(叶片数量): 18

Louvre Size(叶片尺寸): 686mm

Rail Size(上下板尺寸): 738mm

Order No(订单号): BAI G361575 MCGOWAN

Item(序号): 2

Room(房间号): LOUNGE 2

Louvre Size(叶片类型): 76mm

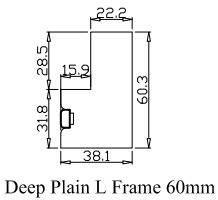

Deep Plain L Frame 60mm

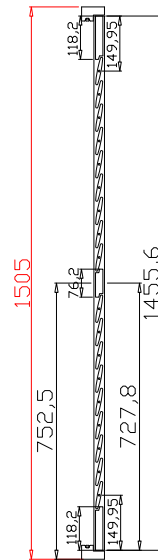
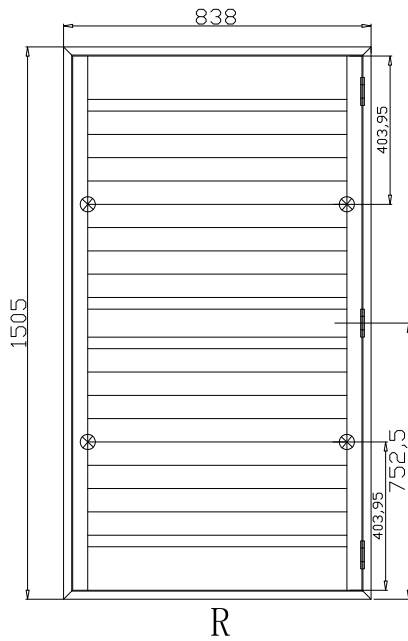
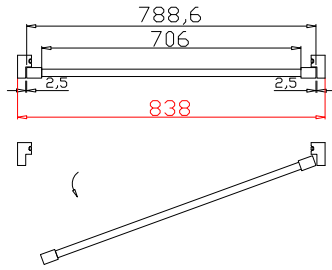

9

9

NOTES:

Shutter Color: Timeless White(覆盖色)

Hinges Color: White(白色)

Qty(数量): 1

Material(材质): Paulownia(桐木)

Configuration(窗扇结构): R,IN, 4Side, 41.3mm Butt, Deep Plain L Frame 60mm

Tilt rod type(拉杆类型): Easy tilt rod(齿条拉杆)

Louvre Quantity(叶片数量): 18

Louvre Size(叶片尺寸): 704mm

Rail Size(上下板尺寸): 756mm

Order No(订单号): BAI G361575 MCGOWAN

Item(序号): 4

Room(房间号): LOUNGE 4

Louvre Size(叶片类型): 76mm

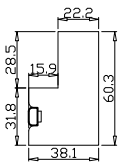

Deep Plain L Frame 60mm

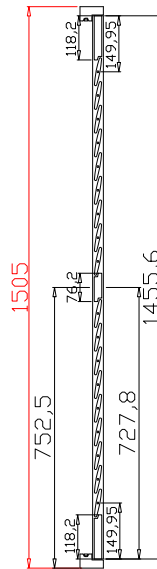
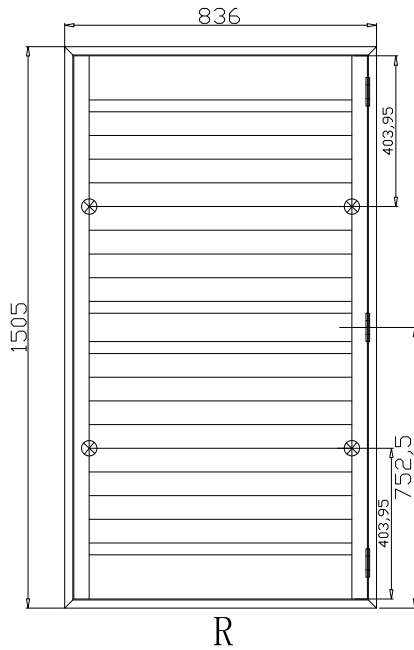
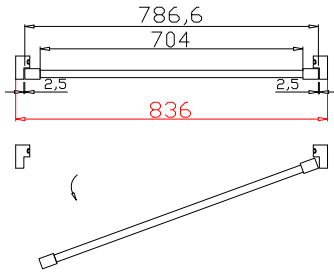

9

9

NOTES:

Shutter Color: Timeless White(覆盖色)

Hinges Color: White(白色)

Qty(数量): 1

Material(材质): Paulownia(桐木)

Configuration(窗扇结构): R,IN, 4Side, 41.3mm Butt, Deep Plain L Frame 60mm

Tilt rod type(拉杆类型): Easy tilt rod(齿条拉杆)

Louvre Quantity(叶片数量): 18

Louvre Size(叶片尺寸): 702mm

Rail Size(上下板尺寸): 754mm

Order No(订单号):BAI G361575 MCGOWAN

Item(序号): 5

Room(房间号): LOUNGE 5

Louvre Size(叶片类型): 76mm

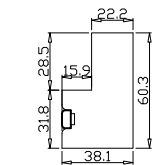

Deep Plain L Frame 60mm

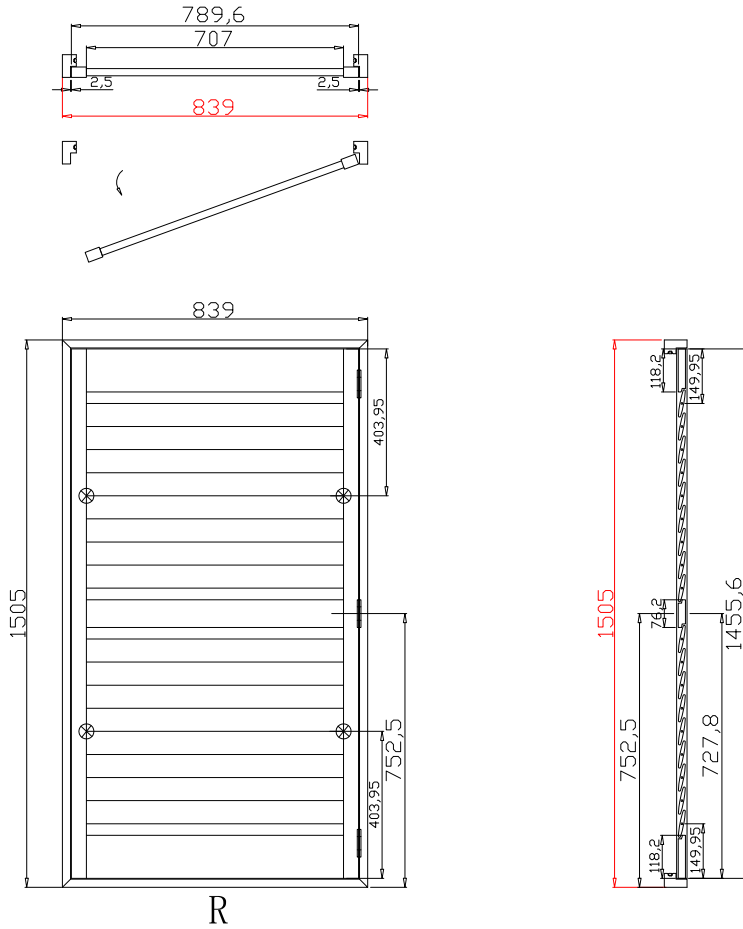

9

9

NOTES:

Shutter Color: Timeless White(覆盖色)

Hinges Color: White(白色)

Qty(数量): 1

Material(材质): Paulownia(桐木)

Configuration(窗扇结构): R,IN, 4Side, 41.3mm Butt, Deep Plain L Frame 60mm

Tilt rod type(拉杆类型): Easy tilt rod(齿条拉杆)

Louvre Quantity(叶片数量): 18

Louvre Size(叶片尺寸): 705mm

Rail Size(上下板尺寸): 757mm

Order No(订单号): BAI G361575 MCGOWAN

Item(序号): 6

Room(房间号): LOUNGE 6

Louvre Size(叶片类型): 76mm

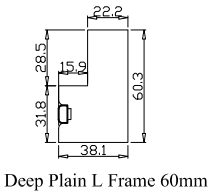

Deep Plain L Frame 60mm

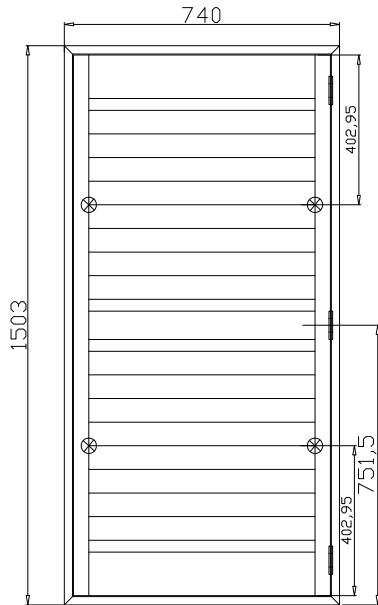
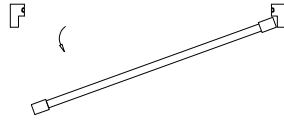
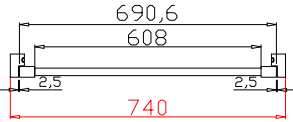

R

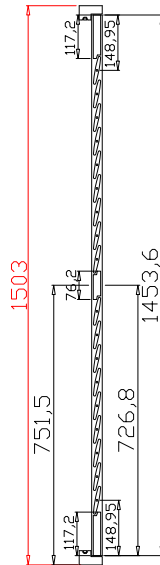

9

9

NOTES:

Shutter Color: Timeless White(覆盖色)

Hinges Color: White(白色)

Qty(数量): 1

Material(材质): Paulownia(桐木)

Configuration(窗扇结构): R,IN, 4Side, 41.3mm Butt, Deep Plain L Frame 60mm

Tilt rod type(拉杆类型): Easy tilt rod(齿条拉杆)

Louvre Quantity(叶片数量): 18

Louvre Size(叶片尺寸): 606mm

Rail Size(上下板尺寸): 658mm

Order No(订单号):BAI G361575 MCGOWAN

Item(序号): 7

Room(房间号): LH BED 1

Louvre Size(叶片类型): 76mm

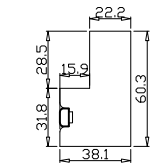

Deep Plain L Frame 60mm

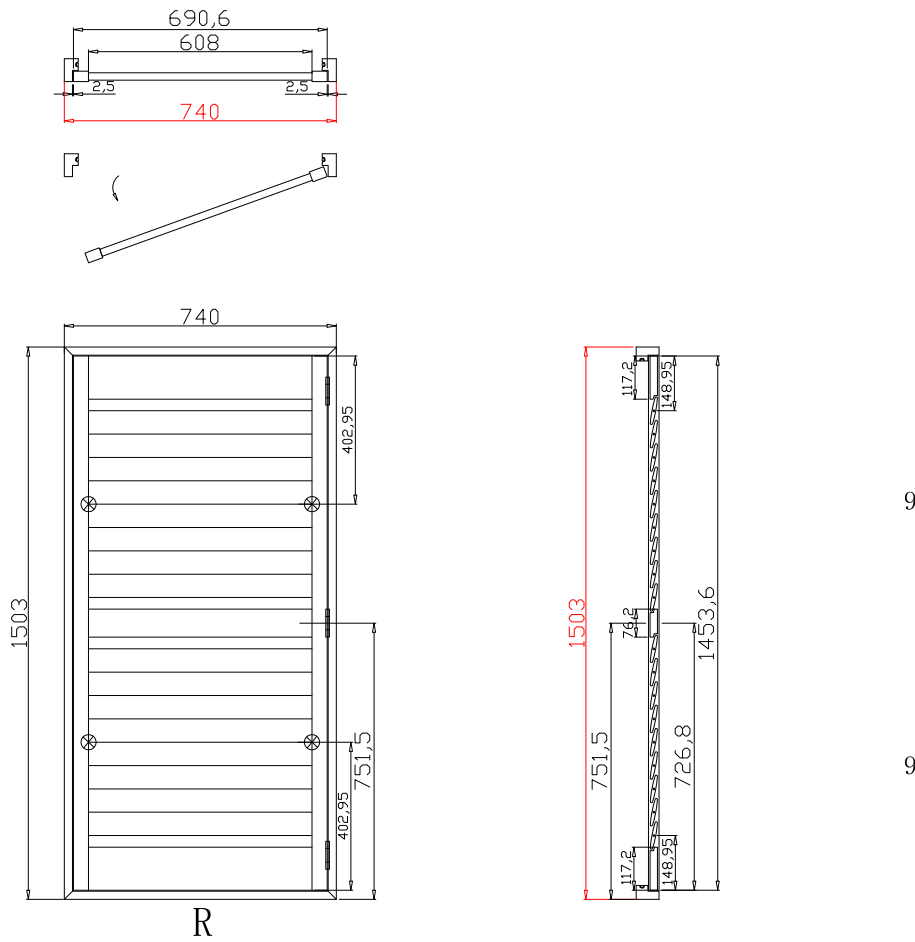

9

9

R

NOTES:

Shutter Color: Timeless White(覆盖色)

Hinges Color: White(白色)

Qty(数量): 1

Material(材质): Paulownia(桐木)

Configuration(窗扇结构): R,IN, 4Side, 41.3mm Butt, Deep Plain L Frame 60mm

Tilt rod type(拉杆类型): Easy tilt rod(齿条拉杆)

Louvre Quantity(叶片数量): 18

Louvre Size(叶片尺寸): 606mm

Rail Size(上下板尺寸): 658mm

Order No(订单号): BAI G361575 MCGOWAN

Item(序号): 8

Room(房间号): LH BED 2

Louvre Size(叶片类型): 76mm

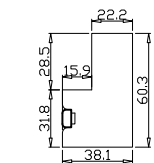

Deep Plain L Frame 60mm