



CP INTERIORS

Quotes move to this one as ordered at the same time.

QUOTE

To: Mr & Mrs.Powell Langstone House Belle Hougue Avenue, La Grande Route Des Sablons Grouville JE3 9 BL
Job Number: SO17541 Q1
Customer Reference: Duette Blinds And Insect Screens - Kitchen
Quote Date: Thursday 19 Mar 2026
Deposit required: £ 4,876.20
Your Contact: Tamara

Our Price Promise to you
We are so confident our pricing is competitive, that we will beat any written quotation for equivalent product by 5%

To supply and fit unless otherwise stated.

Table with 5 columns: Location, Product, Description, Qty, Price. It lists various kitchen window treatments like Honeycomb / Pleated blinds for different windows and doors, with their respective quantities and prices.

Kitchen	<b>Insect Screen</b>	Genius 46 Vertical Sprung operated retractable roller window screen (MGVS), with white hardware and charcoal mesh. Slow close brake. Hand operation.	1	£ 388.00
Large Living Room W1	<b>Honeycomb / Pleated blind</b>	Duette BB11, tensioned to bottom rail, with magnolia hardware, in Elan DuoTone Papyrus 0161. Hand operation with a handle.	1	£ 350.00
Large Living Room W2	<b>Honeycomb / Pleated blind</b>	Duette BB11, tensioned to bottom rail, with magnolia hardware, in Elan DuoTone Papyrus 0161. Hand operation with a handle.	1	£ 430.00
Large Living Room W3	<b>Honeycomb / Pleated blind</b>	Duette BB11, tensioned to bottom rail, with magnolia hardware, in Elan DuoTone Papyrus 0161. Hand operation with a handle.	1	£ 430.00
Large Living Room W4	<b>Honeycomb / Pleated blind</b>	Duette BB11, tensioned to bottom rail, with magnolia hardware, in Elan DuoTone Papyrus 0161. Hand operation with a handle.	1	£ 350.00
Living Room	<b>Insect Screen</b>	Genius 46 Vertical Sprung operated retractable roller window screen (MGVS), with white hardware and charcoal mesh. Slow close brake. Hand operation.	1	£ 472.00
		Duette BB11, tensioned to bottom rail, with magnolia hardware, in Elan DuoTone Papyrus 0161. Hand operation with a handle.		
Small Upstairs TV Room	<b>Honeycomb / Pleated blind</b>		2	£ 640.00
		Duette BB11, tensioned to bottom rail, with magnolia hardware, in Batiste Sheer Full Tone Papyrus 0161. Hand operation with a handle.		
Main Bedroom W1 and W2	<b>Honeycomb / Pleated blind</b>		2	£ 1,508.00
Main Bedroom W3 and W4	<b>Honeycomb / Pleated blind</b>		2	£ 968.00

**Terms:** 40% deposit due with order, 40% on delivery & final 20% on completion

**\*\* To go ahead with this quote please make deposit payment. To pay by card call us on 01534 768141 \*\***

Direct Deposit - Sort Code: 60-12-03 Account: 66577772

If you have any queries please call us on 01534 768141 or visit our showroom  
Rue des Pres Trading Estate St Saviour

**\*\* For Our Terms & Conditions of Sale please go to [www.cpinteriors.je](http://www.cpinteriors.je) \*\***

<b>Subtotal</b>	<b>£ 11,610.00</b>
<b>GST</b>	<b>£ 580.50</b>
<b>Total</b>	<b>£ 12,190.50</b>
Paid amount	£ 4,876.20
<b>Total amount</b>	<b>£ 7,314.30</b>

Please note: This quotation is only valid for acceptance for 7 days. Our estimate does not include any electrical work or additional carpentry work to install the above unless otherwise specified. Please note there is a handling charge on customer own fabric of £7.50 per metre. Due to high costs of labour, pre-arranged missed fitting appointments will be charged on a time-wasted basis. Settlement is due on completion of works and an administration charge of £25 will be added per month if unpaid within 30 days. We reserve the right to charge for design, advice and liaison work carried out should an order not be placed. Goods remain the property of CP Interiors until full settlement is received. Should payment not be received we reserve the right to attend premises during working hours to remove goods and not be required to make good. Our full terms and conditions apply and are available on request.

Unit 8, Greenlea Park  
 Prince Georges Road  
 Merton, SW19 2JD  
 Tel : 020 8648 6008

<b>VAT REG NO</b>	<b>TAX DATE</b>	<b>Ref Number</b>
GB479032181	05-03-2026	ON090612
<b>Cust. Acc. No.</b>	<b>P.O. No.</b>	<b>TERMS</b>
CP001	SO17541 Powell	28th of next month

**Estimated date of Despatch :** 10-04-2026

<b>INVOICE TO</b>
CP Interiors Rue Des Pres Trading Estate St Saviour Jersey JE2 7QN

<b>SHIP TO</b>
DSV Road Ltd 10 Brunel Way Segensworth Industrial Estate Fareham Hampshire PO15 5TX

DESCRIPTION	QTY	RATE	AMOUNT
To Supply 1 Cellular - Standard - Side Window Blind Large Living Room W1, 865, 1615 , Blind Size, 32mm - Elan DuoTone, Papyrus 0161,BB11 - Band B, EOS Spring Clip Top Fix Brackets, Parchment / Magnolia Rails RAL9001	1	140.00	140.00
To Supply 1 Cellular - Standard - Side Window Blind Large Living Room W2, 970, 2035 , Blind Size, 32mm - Elan DuoTone, Papyrus 0161,BB11 - Band B, EOS Spring Clip Top Fix Brackets, Parchment / Magnolia Rails RAL9001	1	172.00	172.00
To Supply 1 Cellular - Standard - Side Window Blind Large Living Room W3, 970, 2035 , Blind Size, 32mm - Elan DuoTone, Papyrus 0161,BB11 - Band B, EOS Spring Clip Top Fix Brackets, Parchment / Magnolia Rails RAL9001	1	172.00	172.00
To Supply 1 Cellular - Standard - Side Window Blind Large Living Room W4, 865, 1615 , Blind Size, 32mm - Elan DuoTone, Papyrus 0161,BB11 - Band B, EOS Spring Clip Top Fix Brackets, Parchment / Magnolia Rails RAL9001	1	140.00	140.00
To Supply 1 Cellular - Standard - Side Window Blind Kitchen W1, 595, 1620 , Blind Size, 32mm - Elan DuoTone, Papyrus 0161,BB11 - Band B, EOS Spring Clip Top Fix Brackets, Parchment / Magnolia Rails RAL9001	1	100.00	100.00
To Supply 1 Cellular - Standard - Side Window Blind Kitchen W2, 595, 1620 , Blind Size, 32mm - Elan DuoTone, Papyrus 0161,BB11 - Band B, EOS Spring Clip Top Fix Brackets, Parchment / Magnolia Rails RAL9001	1	100.00	100.00
To Supply 1 Cellular - Standard - Side Window Blind Kitchen W3, 575, 1720 , Blind Size, 32mm - Elan DuoTone, Papyrus 0161,BB11 - Band B, EOS Spring Clip Top Fix Brackets, Parchment / Magnolia Rails RAL9001	1	100.00	100.00
To Supply 1 Cellular - Standard - Side Window Blind Kitchen W4, 785, 1720 , Blind Size, 32mm - Elan DuoTone, Papyrus 0161,BB11 - Band B, EOS Spring Clip Top Fix Brackets, Parchment / Magnolia Rails RAL9001	1	125.00	125.00
To Supply 1 Cellular - Standard - Side Window Blind Kitchen W5, 790, 1720 , Blind Size, 32mm - Elan DuoTone, Papyrus 0161,BB11 - Band B, EOS Spring Clip Top Fix Brackets, Parchment / Magnolia Rails RAL9001	1	125.00	125.00
To Supply 1 Cellular - Night & Day - Side Window Blind Kitchen W6, 1020, 2040 , Blind Size, 32mm - Elan DuoTone, Papyrus 0161,BB31 - Night and Day - Band B, EOS Spring Clip Top Fix Brackets, Parchment Rails - Magnolia RAL9001	1	188.00	188.00
To Supply 1 Cellular - Night & Day - Side Window Blind Kitchen W6, 1020, 2040 , Blind Size, 32mm - Batiste Sheer FullTone, Papyrus 0161,BB31 - Night and Day - Band D+10%, EOS Spring Clip Top Fix Brackets, Parchment Rails - Magnolia RAL9001	1	388.30	388.30
To Supply 1 Cellular - Night & Day - Side Window Blind Kitchen W7, 1020, 2040 , Blind Size, 32mm - Elan DuoTone, Papyrus 0161,BB31 - Night and Day - Band B, EOS Spring Clip Top Fix Brackets, Parchment Rails - Magnolia RAL9001	1	188.00	188.00
To Supply 1 Cellular - Night & Day - Side Window Blind Kitchen W7, 1020, 2040 , Blind Size, 32mm - Batiste Sheer FullTone, Papyrus 0161,BB31 - Night and Day - Band D+10%, EOS Spring Clip Top Fix Brackets, Parchment Rails - Magnolia RAL9001	1	388.30	388.30

Unit 8, Greenlea Park  
 Prince Georges Road  
 Merton, SW19 2JD  
 Tel : 020 8648 6008

<b>VAT REG NO</b>	<b>TAX DATE</b>	<b>Ref Number</b>
GB479032181	05-03-2026	ON090612
<b>Cust. Acc. No.</b>	<b>P.O. No.</b>	<b>TERMS</b>
CP001	SO17541 Powell	28th of next month

**Estimated date of Despatch :** 10-04-2026

<b>INVOICE TO</b>
CP Interiors Rue Des Pres Trading Estate St Saviour Jersey JE2 7QN

<b>SHIP TO</b>
DSV Road Ltd 10 Brunel Way Segensworth Industrial Estate Fareham Hampshire PO15 5TX

DESCRIPTION	QTY	RATE	AMOUNT
To Supply 1 Cellular - Standard - Side Window Blind Kitchen W8, 790, 1720 , Blind Size, 32mm - Elan DuoTone, Papyrus 0161,BB11 - Band B, EOS Spring Clip Top Fix Brackets, Parchment / Magnolia Rails RAL9001	1	125.00	125.00
To Supply 1 Cellular - Standard - Side Window Blind Kitchen W9, 790, 1720 , Blind Size, 32mm - Elan DuoTone, Papyrus 0161,BB11 - Band B, EOS Spring Clip Top Fix Brackets, Parchment / Magnolia Rails RAL9001	1	125.00	125.00
To Supply 1 Cellular - Standard - Side Window Blind Kitchen W10, 575, 1720 , Blind Size, 32mm - Elan DuoTone, Papyrus 0161,BB11 - Band B, EOS Spring Clip Top Fix Brackets, Parchment / Magnolia Rails RAL9001	1	100.00	100.00
To Supply 1 Cellular - Standard - Side Window Blind Kitchen W11, 595, 1620 , Blind Size, 32mm - Elan DuoTone, Papyrus 0161,BB11 - Band B, EOS Spring Clip Top Fix Brackets, Parchment / Magnolia Rails RAL9001	1	100.00	100.00
To Supply 1 Cellular - Standard - Side Window Blind Kitchen W12, 595, 1620 , Blind Size, 32mm - Elan DuoTone, Papyrus 0161,BB11 - Band B, EOS Spring Clip Top Fix Brackets, Parchment / Magnolia Rails RAL9001	1	100.00	100.00
To Supply 1 Cellular - Standard - Side Window Blind Kitchen Single Door, 620, 2040 , Blind Size, 32mm - Elan DuoTone, Papyrus 0161,BB11 - Band B, EOS Spring Clip Top Fix Brackets, Parchment / Magnolia Rails RAL9001	1	128.00	128.00
To Supply 1 Cellular - Standard - Side Window Blind Small Upstairs TV Room W1, 805, 1955 , Blind Size, 32mm - Elan DuoTone, Papyrus 0161,BB11 - Band B, EOS Spring Clip Top Fix Brackets, Parchment / Magnolia Rails RAL9001	1	149.00	149.00
To Supply 1 Cellular - Standard - Side Window Blind Small Upstairs TV Room W2, 805, 1955 , Blind Size, 32mm - Elan DuoTone, Papyrus 0161,BB11 - Band B, EOS Spring Clip Top Fix Brackets, Parchment / Magnolia Rails RAL9001	1	149.00	149.00
To Supply 1 Cellular - Standard - Side Window Blind Main Bedroom W1, 810, 1960 , Blind Size, 32mm - Batiste Sheer FullTone, Papyrus 0161,BB11 - Band D+10%, EOS Spring Clip Top Fix Brackets, Parchment / Magnolia Rails RAL9001	1	301.40	301.40
To Supply 1 Cellular - Standard - Side Window Blind Main Bedroom W2, 810, 1960 , Blind Size, 32mm - Batiste Sheer FullTone, Papyrus 0161,BB11 - Band D+10%, EOS Spring Clip Top Fix Brackets, Parchment / Magnolia Rails RAL9001	1	301.40	301.40
To Supply 1 Cellular - Standard - Side Window Blind Main Bedroom W3, 945, 915 , Blind Size, 32mm - Batiste Sheer FullTone, Papyrus 0161,BB11 - Band D+10%, EOS Spring Clip Top Fix Brackets, Parchment / Magnolia Rails RAL9001	1	193.60	193.60





**SO17541 Powell**

Blind	Location	Qty	Type	Width	Drop	Blind/recess	Fabric 1	Fabric 2	Operation
16	Large Living Room W1	1	BB11	865	1615	B/S	Elan Duotone Papyrus 0161		Hand
17	Large Living Room W2	1	BB11	970	2035	B/S	Elan Duotone Papyrus 0161		Hand
18	Large Living Room W3	1	BB11	970	2035	B/S	Elan Duotone Papyrus 0161		Hand
19	Large Living Room W4	1	BB11	865	1615	B/S	Elan Duotone Papyrus 0161		Hand
1	Kitchen W1	1	BB11	595	1620	B/S	Elan Duotone Papyrus 0161		Hand
2	Kitchen W2	1	BB11	595	1620	B/S	Elan Duotone Papyrus 0161		Hand
3	Kitchen W3	1	BB11	575	1720	B/S	Elan Duotone Papyrus 0161		Hand
4	Kitchen W4	1	BB11	785	1720	B/S	Elan Duotone Papyrus 0161		Hand
5	Kitchen W5	1	BB11	790	1720	B/S	Elan Duotone Papyrus 0161		Hand
6	Kitchen W6 *	1	BB31	1020	2040	B/S	Elan Duotone Papyrus 0161	Batiste Sheer Full Tone Papyrus 0161	Hand
7	Kitchen W7*	1	BB31	1020	2040	B/S	Elan Duotone Papyrus 0161	Batiste Sheer Full Tone Papyrus 0161	Hand
8	Kitchen W8	1	BB11	790	1720	B/S	Elan Duotone Papyrus 0161		Hand
9	Kitchen W9	1	BB11	790	1720	B/S	Elan Duotone Papyrus 0161		Hand
10	Kitchen W10	1	BB11	575	1720	B/S	Elan Duotone Papyrus 0161		Hand

11	Kitchen W11	1	BB11	595	1620	B/S	Elan Duotone Papyrus 0161		Hand
12	Kitchen W12	1	BB11	595	1620	B/S	Elan Duotone Papyrus 0161		Hand
13	Kitchen Single Door	1	BB11	620	2040	B/S	Elan Duotone Papyrus 0161		Hand
14	Small Upstairs TV Room W1	1	BB11	805	1955	B/S	Elan Duotone Papyrus 0161		Hand
15	Small Upstairs TV Room W2	1	BB11	805	1955	B/S	Elan Duotone Papyrus 0161		Hand
20	Main Bedroom W1	1	BB11	810	1960	B/S	Batiste Sheer Full Tone Papyrus 0161		Hand
21	Main Bedroom W2	1	BB11	810	1960	B/S	Batiste Sheer Full Tone Papyrus 0161		Hand
22	Main Bedroom W3	1	BB11	945	915	B/S	Batiste Sheer Full Tone Papyrus 0161		Hand
23	Main Bedroom W4	1	BB11	945	915	B/S	Batiste Sheer Full Tone Papyrus 0161		Hand

**Magnolia hardware for all.**

\*If possible with two handles due to width.



**Invoice To:-**

CP Interiors {Carpet Protect 2YY}  
Rue Des Pres Trading Estate  
St Saviour  
JERSEY  
CHANNEL ISLANDS  
JE2 7QN

**Deliver To:-**

CP Interiors  
Rue Des Pres Trading Estate  
St Saviour  
JERSEY  
CHANNEL ISLAND  
JE2 7QN

**Order No 78835**

Order Date 16/03/2026  
Est. Despatch//  
A/C Code CPSU01  
Your Ref **SO17581**  
Packaging Flydor  
Shipping DX/Channel Islands  
3/5 Day <3m

tamara@cpinteriors.je

Tamara Lopez Domingu/01534768141

em	Code	Description	Qty	Price	Tot:
10	MGVS SO17581	<p>Genius 46 Vertical Sprung Operated Retractable Roller Window Screen <b>1150w x 2050h</b></p> <p><b>Inc. Slow Rise Brake</b></p> <p>White Frame/Charcoal Mesh Face fix brackets fitted during manufacture. 16/03/26 - Size amended</p> <p><b>IMPORTANT - PLEASE ADVISE</b></p> <ul style="list-style-type: none"> <li>o Please advise if you want face fixing brackets to be fitted during manufacture - Allow 15mm for fitting</li> <li>o OPTION: Slow Close 8366 Brake.</li> <li>o OPTION: Reinforcing Pull Bar Handle.</li> <li>o OPTION: Tuff Screen pet resistant mesh, (NOT WITH BRAKE).</li> <li>o Reveal or Face Fitting.</li> <li>o G2605.x PVC Domed (7mm) Cover Caps for Side Guides.</li> <li>o <b>NOT RECOMMENDED FOR COMMERCIAL KITCHEN USE.</b></li> </ul> <p style="text-align: center;">Food Hygiene - Regulations</p> <p style="text-align: center;"><a href="#">Click for more information :MGVS</a></p> <p>Tariff/Origin:- 7610100000/UK</p>	1.00	151.50	151.5
20	MGVS SO17581	<p>Genius 46 Vertical Sprung Operated Retractable Roller Window Screen <b>890w x 1885h</b></p>	1.00	138.70	138.7

em Code	Description	Qty	Price	Total
	<b>#1:Inc. Slow Rise Brake</b>			
	White Frame/Charcoal Mesh			
	Face fix brackets fitted during manufacture. 17/03/26 - Size amended			
	Tariff/Origin:- 7610100000/UK			
Estimated 8kgs.		VAT No: GB 831 9321 38 EORI No: GB831932138000 Tariff Summary:- 7610100000\***290.20 Total £290.20 INCO Terms:- DAP	Total £ Carriage/P&P £ Sub Total £ VAT @0.00% Order Total £	290.2 50.0 340.2 0.0 340.2

**PLEASE SIGN ALL DETAILS ARE CORRECT & OK TO PROCEED.**

**OR  
REPLY TO THIS EMAIL.**

**PRINT NAME :.....**

**DATE OF CONFIRMATION :.....**

**OFFICE HOURS:**  
**Oct - Mar** 08:30 to 16:00.  
**Apr - Sep** 08:30 to 17:00.  
 Lunch 13:00-13:30, ☎ close at 16:00.



**New 2026 Price List**  
 Effective 2nd Feb 2026  
**WhatsApp:**  
**07572 975 582**



Flydor Limited, Priory Works, Newton Street, Newton St Faith, Norwich, Norfolk, NR10 3AD, England.  
 Tel. +44 (0)1603 897 799

Web: [www.flydor.co.uk](http://www.flydor.co.uk)  
 Registered in England No. 4946756

Staff Name Adrian  
 Order No SO17541  
 Surveyor Measurer

Contact Address  
 Powell

Langstone House Belle Hougue Avenue, La Grande Route Des Sablons Grouville JE3 9 BL  
 07797751479 859718

Customer Ref

Account Manager: Tamara

Date 28-01-2026

Time 15:00 PM

PTO

call lena line first

Notes : To measure to replace existing blinds with possibly the same (Duette). Also insect screens. Please bring Duette samples.

Location	Supplier	Blind Type /Description	Colour	Qty	Width	Drop	Fitting Height	B or R	Controls	Brackets	Surface	Unit Price
1 Kitchen	WXA	Duette + Sheer		1	595	1620	S	B	Hand	TOP		
2		opaque + sheer		1	595	1620	S			+ Bottom		
3		Tension Model		1	575	1720	S					
4		with sail top		1	785	1720	S					
5		# Bottom	790	1	<del>785</del>	1720	S					
6		<del>DE</del>	790	<del>2</del>	1020	2040	D		Double fabric	→ two handles		
7			790	<del>2</del>	<del>785</del>	1720	S					
8		Duette opaque		1	575	1720	S					
9		only		1	595	1620	S					
10				1	595	1620	S					
11				1	620	2040	S					
12 Kitchen Slide Door												

Comments: Screen Batiste Sheer Fulltone  
~~999~~ Papyrus  
 Opaque → Elan Duo 9310  
 Papyrus  
 Bracket wedge pushes needed

Surface Fixing  
 C=Concrete  
 W=Wood  
 M-Metal  
 B=Brick  
 P-Plastic  
 T=Tile

Order  
 Quote  
 Customer Signature  
 X I have checked and agree with the above choices  
 Target Fitting Date

14) Small up stairs TV room 2 x 3 ~~780 x 2040~~ 805 x 1935 1 hand  
Top & Bottom fix

16) Large Lv ~~Q~~ Double 1160 x 2080 lit R/S Free hanging cord op  
 17) Single 1200 x 2460 L  
 18) Sheer 1200 x 2460 R  
 19) Sheer 1160 x 2080 R

*Separate Q*

20) 21) main bed 2 x 3 ~~810~~ 1960 ~~1815~~ 1815 1 hand  
Top & Bottom rails

22) Double 945 x 915 4

23) Sheer 945 x 515 1

measured 27th Feb  
 Insect screen External 1100 x 1065 Hers  
BS  
 ladder 2x Gung ~~1100 x 1075~~ Brown  
Hers  
Green

Staff Name: Adrian  
 Order No: SO17541  
 Surveyor: Measurer

Contact Address: Powell  
 Langstone House Belle Hougue Avenue, La Grande Route Des Sablons Grouville JE3 9 BL  
 07797751479 859718

Customer Ref: Luxaflex Duetto Blinds  
 Date: 09-02-2026  
 Account Manager: Tamara

Time: 14:00 PM

Notes: To drop off samples

Blinds need remeasure by Sen must see very tight

Large

Location	Supplier	Blind Type / Description	Colour	Qty	Width	Drop	Fitting Height	B or R	Controls	Brackets	Surface	Unit Price
16		Duetto	Elan Duo	1	865	1615			Tensioned		Top	
17			<del>9370</del>	1	970	2035	BS		Top & bottom rail			
18			Papyrus	1	970	2035			Hand op.			
19				1	865	1615						
		Insect (interm)		1	1070	2050			to be added to width		Face	
		Same white head			2110	Drop						
					Spider							
					side channels + head							
		insect.		1	810	1845	1845	BS				
					inside							

Comments:

Surface Fixing  
 C=Concrete  
 W=Wood  
 M=Metal  
 B=Brick  
 P=Plastic  
 T=Tile

Order

Customer Signature  
 X

I have checked and agree with the above choices

Quote

Target Fitting Date





# CP INTERIORS

## QUOTE

**To:** Mr & Mrs.Powell  
Langstone House  
Belle Hougue Avenue, La Grande Route Des Sablons  
Grouville  
JE3 9 BL

**Job Number:** SO17541 Q1

**Customer Reference:** Duette Blinds And Insect Screens - Kitchen

**Quote Date:** Friday 20 Feb 2026

**Deposit required:** £ 3,392.55

**Your Contact:** Tamara

Our Price Promise to you  
We are so confident our pricing is competitive, that we will beat any written quotation for equivalent product by 5%

### To supply and fit unless otherwise stated.

Location	Product	Description	Qty	Price
		Duette BB11, tensioned to bottom rail, with magnolia hardware, in Elan DuoTone Papyrus 0161. Hand operation with a handle.		
Kitchen W1	Honeycomb/Pleated blind		1	£ 270.00
Kitchen W2	Honeycomb/Pleated blind		1	£ 270.00
Kitchen W3	Honeycomb/Pleated blind		1	£ 270.00
Kitchen W4	Honeycomb/Pleated blind		1	£ 313.00
Kitchen W5	Honeycomb/Pleated blind		1	£ 313.00
Kitchen W8	Honeycomb/Pleated blind		1	£ 313.00
Kitchen W9	Honeycomb/Pleated blind		1	£ 313.00
Kitchen W10	Honeycomb/Pleated blind		1	£ 270.00
Kitchen W11	Honeycomb/Pleated blind		1	£ 270.00
Kitchen W12	Honeycomb/Pleated blind		1	£ 270.00
Kitchen Single Door	Honeycomb/Pleated blind		1	£ 320.00
		Duette BB31, tensioned to bottom rail, with magnolia hardware, in Elan DuoTone Papyrus 0161 and Batiste Sheer Full Tone papyrus 0161. Hand operation with handles.		
Kitchen W6 - Double Door	Honeycomb/Pleated blind		1	£ 1,441.00
Kitchen W7 - Double Door	Honeycomb/Pleated blind		1	£ 1,441.00

Living Room	<b>Insect Screen</b>	Genius 46 Vertical Sprung operated retractable roller window screen (MGVS), with white hardware and charcoal mesh. Slow close brake. Hand operation.	1	£ 388.00
-------------	----------------------	--	---	----------

Terms: 50% deposit due with order, 50% on completion

**Subtotal** £ 6,462.00

**\*\* To go ahead with this quote please make deposit payment. To pay by card call us on 01534 768141 \*\***

**GST** £ 323.10

Direct Deposit - Sort Code: 60-12-03 Account: 66577772

**Total** £ 6,785.10

If you have any queries please call us on 01534 768141 or visit our showroom  
Rue des Pres Trading Estate St Saviour

Paid amount £ 0.00

**Total amount** £ 6,785.10

**\*\* For Our Terms & Conditions of Sale please go to [www.cpinteriors.je](http://www.cpinteriors.je) \*\***

Please note: This quotation is only valid for acceptance for 7 days. Our estimate does not include any electrical work or additional carpentry work to install the above unless otherwise specified. Please note there is a handling charge on customer own fabric of £7.50 per metre. Due to high costs of labour, pre-arranged missed fitting appointments will be charged on a time-wasted basis. Settlement is due on completion of works and an administration charge of £25 will be added per month if unpaid within 30 days. We reserve the right to charge for design, advice and liaison work carried out should an order not be placed. Goods remain the property of CP Interiors until full settlement is received. Should payment not be received we reserve the right to attend premises during working hours to remove goods and not be required to make good. Our full terms and conditions apply and are available on request.



# CP INTERIORS

## QUOTE

**To:** Mr & Mrs. Powell  
Langstone House  
Belle Hougue Avenue, La Grande Route Des Sablons  
Grouville  
JE3 9 BL

**Job Number:** SO17602 Q1

**Customer Reference:** Small Upstairs Living Room & Main Bedroom

**Quote Date:** Friday 20 Feb 2026

**Deposit required:** £ 1,635.90

**Your Contact:** Tamara

Our Price Promise to you  
We are so confident our pricing is competitive, that we will beat any written quotation for equivalent product by 5%

### To supply and fit unless otherwise stated.

Location	Product	Description	Qty	Price
		Duette BB11, tensioned to bottom rail, with magnolia hardware, in Elan DuoTone Papyrus 0161. Hand operation with a handle.		
Small Upstairs TV Room	Honeycomb/Pleated blind		2	£ 640.00
		Duette BB11, tensioned to bottom rail, with magnolia hardware, in Batiste Sheer Full Tone Papyrus 0161. Hand operation with a handle.		
Main Bedroom W1 and W2	Honeycomb/Pleated blind		2	£ 1,508.00
Main Bedroom W3 and W4	Honeycomb/Pleated blind		2	£ 968.00
<b>Terms:</b> 50% deposit due with order, 50% on completion			<b>Subtotal</b>	<b>£ 3,116.00</b>
<b>** To go ahead with this quote please make deposit payment. To pay by card call us on 01534 768141 **</b>			<b>GST</b>	<b>£ 155.80</b>
Direct Deposit - Sort Code: 60-12-03 Account: 66577772			<b>Total</b>	<b>£ 3,271.80</b>
If you have any queries please call us on 01534 768141 or visit our showroom Rue des Pres Trading Estate St Saviour			Paid amount	£ 0.00
			<b>Total amount</b>	<b>£ 3,271.80</b>

\*\* For Our Terms & Conditions of Sale please go to [www.cpinteriors.je](http://www.cpinteriors.je) \*\*

Please note: This quotation is only valid for acceptance for 7 days. Our estimate does not include any electrical work or additional carpentry work to install the above unless otherwise specified. Please note there is a handling charge on customer own fabric of £7.50 per metre. Due to high costs of labour, pre-arranged missed fitting appointments will be charged on a time-wasted basis. Settlement is due on completion of works and an administration charge of £25 will be added per month if unpaid within 30 days. We reserve the right to charge for design, advice and liaison work carried out should an order not be placed. Goods remain the property of CP Interiors until full settlement is received. Should payment not be received we reserve the right to attend premises during working hours to remove goods and not be required to make good. Our full terms and conditions apply and are available on request.





# CP INTERIORS

## QUOTE

**To:** Mr & Mrs. Powell  
Langstone House  
Belle Hougue Avenue, La Grande Route Des Sablons  
Grouville  
JE3 9 BL

**Job Number:** SO17581 Q1

**Quote Date:** Friday 20 Feb 2026

**Customer Reference:** Duette Blinds And Insect Screens - Large Living Room

**Deposit required:** £ 1,066.80

**Your Contact:** Tamara

Our Price Promise to you  
We are so confident our pricing is competitive, that we will beat any written quotation for equivalent product by 5%

### To supply and fit unless otherwise stated.

Location	Product	Description	Qty	Price
Large Living Room W1	<b>Honeycomb/Pleated blind</b>	Duette BB11, tensioned to bottom rail, with magnolia hardware, in Elan DuoTone Papyrus 0161. Hand operation with a handle.	1	£ 350.00
Large Living Room W2	<b>Honeycomb/Pleated blind</b>	Duette BB11, tensioned to bottom rail, with magnolia hardware, in Elan DuoTone Papyrus 0161. Hand operation with a handle.	1	£ 430.00
Large Living Room W3	<b>Honeycomb/Pleated blind</b>	Duette BB11, tensioned to bottom rail, with magnolia hardware, in Elan DuoTone Papyrus 0161. Hand operation with a handle.	1	£ 430.00
Large Living Room W4	<b>Honeycomb/Pleated blind</b>	Duette BB11, tensioned to bottom rail, with magnolia hardware, in Elan DuoTone Papyrus 0161. Hand operation with a handle.	1	£ 350.00
Living Room	<b>Insect Screen</b>	Genius 46 Vertical Sprung operated retractable roller window screen (MGVS), with white hardware and charcoal mesh. Slow close brake. Hand operation.	1	£ 472.00

**Terms:** 50% deposit due with order, 50% on completion

**Subtotal** £ 2,032.00

**\*\* To go ahead with this quote please make deposit payment. To pay by card call us on 01534 768141 \*\***

**GST** £ 101.60

Direct Deposit - Sort Code: 60-12-03 Account: 66577772

**Total** £ 2,133.60

**Paid amount** £ 0.00

If you have any queries please call us on 01534 768141 or visit our showroom  
Rue des Pres Trading Estate St Saviour

**Total amount** £ 2,133.60

**\*\* For Our Terms & Conditions of Sale please go to [www.cpinteriors.je](http://www.cpinteriors.je) \*\***

Please note: This quotation is only valid for acceptance for 7 days. Our estimate does not include any electrical work or additional carpentry work to install the above unless otherwise specified. Please note there is a handling charge on customer own fabric of £7.50 per metre. Due to high costs of labour, pre-arranged missed fitting appointments will be charged on a time-wasted basis. Settlement is due on completion of works and an administration charge of £25 will be added per month if unpaid within 30 days. We reserve the right to charge for design, advice and liaison work carried out should an order not be placed. Goods remain the property of CP Interiors until full settlement is received. Should payment not be received we reserve the right to attend premises during working hours to remove goods and not be required to make good. Our full terms and conditions apply and are available on request.





# Flydor

FIRST  
for Flyscreen Technology

## QUOTATION

to:-  
amara Lopez Domingu  
  
P Interiors  
  
amara@cpinteriors.je

Address:-  
CP Interiors {Carpet Protect 2YY}  
Rue Des Pres Trading Estate  
St Saviour  
JERSEY  
CHANNEL ISLANDS  
JE2 7QN

Quote No: **28098**

Quote Date: 13/02/2026  
A/C Code: CPSU01  
Your Ref: SO17581  
Deliver To: JE2 7QN

Shipping Method: DX/Channel Islands 3/5  
Day <3m 8Kgs

Item	Product	Qty	Width	Height	Description	Total
05M	MGVS	1	1070	2050	Genius 46 Vertical Sprung Operated Retractable Roller Window Screen Tariff/Origin:- 7610100000/UK #1:Inc. Slow Rise Brake 3.84Kgs Size of opening. Please add side channels to width <ul style="list-style-type: none"> <li>OPTION: Slow Close 8366 Brake.</li> <li>OPTION: Reinforcing Pull Bar Handle.</li> <li>OPTION: Tuff Screen pet resistant mesh, (NOT WITH BRAKE).</li> <li>Reveal or Face Fitting. *</li> <li>G2605.x PVC Domed (7mm) Cover Caps for Side Guides.</li> <li><b>NOT RECOMMENDED FOR COMMERCIAL KITCHEN USE.</b></li> </ul> <div style="border: 1px solid black; padding: 5px; text-align: center;">Food Hygiene - Regulations.</div> <p>*FACE FIX.</p> <p style="text-align: center;"><a href="#">Click for more information :MGVS</a></p>	149.00
06M	MGVS	1	810	2020	Genius 46 Vertical Sprung Operated Retractable Roller Window Screen Tariff/Origin:- 7610100000/UK #1:Inc. Slow Rise Brake 3.36Kgs White Frame/Charcoal Mesh White Frame/Charcoal Mesh	135.30

Size of opening. Please add side channels and top headrail to width and drop.

Item	Product	Qty	Width	Height	Description	Total
<p><b>All measurements are in mm, Width x Height.</b>  <b>Size is the finished overall frame size excluding fittings.</b>  <b>No adjustments or allowances are made by Flydor.</b>  <b>No fixings supplied to fix screen in place.</b>  <b>White frames/charcoal mesh unless otherwise stated.</b>  <b>*VAT, If applicable, charged at rate on day of invoice.</b></p> <p><b>This supply only quotation is valid for 28 days.</b></p>						<p><b>Total £ 284.3</b></p> <p>Shipping £ 50.0</p> <p>Sub Total £ 334.3</p> <p>*VAT @0.00% 0.0</p> <p><b>Quote Total £ 334.3</b></p>

**OFFICE HOURS:**  
**Oct - Mar 08:30 to 16:00.**  
**Apr - Sep 08:30 to 17:00.**  
**Lunch 13:00-13:30, ☒ close at 16:00.**



**New 2026 Price List**  
**Effective 2nd Feb 2026**  
**WhatsApp:**  
**07572 975 582**



Flydor Limited, Priory Works, Newton Street, Newton St Faith, Norwich, Norfolk, NR10 3AD, England.  
 Tel. +44 (0)1603 897 799

Web: [www.flydor.co.uk](http://www.flydor.co.uk)

Registered in England No. 4946756



# Flydor

FIRST  
for Flyscreen Technology

## QUOTATION

O:-  
amara Lopez Domingu  
  
P Interiors  
  
amara@cpinteriors.je

Address:-  
CP Interiors {Carpet Protect 2YY}  
Rue Des Pres Trading Estate  
St Saviour  
JERSEY  
CHANNEL ISLANDS  
JE2 7QN

Quote No: **28098**  
Quote Date: 13/02/2026  
A/C Code: CPSU01  
Your Ref: SO17581  
Deliver To: JE2 7QN  
Shipping Method: DX/Channel Islands 3/5  
Day <3m 8Kgs

Item	Product	Qty	Width	Height	Description	Total
05M	MGVS 	1	<del>1070</del> 1150	<del>2050</del> 3.84Kgs	Genius 46 Vertical Sprung Operated Retractable Roller Window Screen Tariff/Origin:- 7610100000/UK #1:Inc. Slow Rise Brake  <ul style="list-style-type: none"> <li>OPTION: Slow Close 8366 Brake.</li> <li>OPTION: Reinforcing Pull Bar Handle.</li> <li>OPTION: Tuff Screen pet resistant mesh, (NOT WITH BRAKE).</li> <li>Reveal or Face Fitting.</li> <li>G2605.x PVC Domed (7mm) Cover Caps for Side Guides.</li> <li><b>NOT RECOMMENDED FOR COMMERCIAL KITCHEN USE.</b></li> </ul> <div style="border: 1px solid black; padding: 5px; text-align: center;">Food Hygiene - Regulations</div> <p style="text-align: center;"><a href="#">Click for more information :MGVS</a></p> <p>White Frame/Charcoal Mesh</p>	149.01
06M	MGVS	1	<del>810</del> 890	<del>2020</del> 2040 3.36Kgs	Genius 46 Vertical Sprung Operated Retractable Roller Window Screen Tariff/Origin:- 7610100000/UK #1:Inc. Slow Rise Brake  White Frame/Charcoal Mesh	135.31

Item	Product	Qty	width	Height	Description	Total	
<p><b>All measurements are in mm. Width x Height.</b>  <b>Size is the finished overall frame size excluding fittings.</b>  <b>No adjustments or allowances are made by Flydor.</b>  <b>No fixings supplied to fix screen in place.</b>  <b>White frames/charcoal mesh unless otherwise stated.</b>  <b>*VAT, If applicable, charged at rate on day of invoice.</b></p> <p><b>This supply only quotation is valid for 28 days.</b></p>							
						<b>Total £</b>	<b>284.3</b>
						<b>Shipping £</b>	<b>50.0</b>
						<b>Sub Total £</b>	<b>334.3</b>
						<b>*VAT @0.00%</b>	<b>0.0</b>
						<b>Quote Total £</b>	<b>334.3</b>

**OFFICE HOURS:**  
**Oct - Mar 08:30 to 16:00.**  
**Apr - Sep 08:30 to 17:00.**  
**Lunch 13:00-13:30, ☒ close at 16:00.**



**New 2026 Price List**  
**Effective 2nd Feb 2026**  
**WhatsApp:**  
**07572 975 582**



Flydor Limited, Priory Works, Newton Street, Newton St Faith, Norwich, Norfolk, NR10 3AD, England.  
 Tel: +44 (0)1603 897 799

**Web: [www.flydor.co.uk](http://www.flydor.co.uk)**  
**Registered in England No. 4946756**

**Invoice To:-**

CP Interiors {Carpet Protect 2YY}  
Rue Des Pres Trading Estate  
St Saviour  
JERSEY  
CHANNEL ISLANDS  
JE2 7QN

**Deliver To:-**

CP Interiors  
Rue Des Pres Trading Estate  
St Saviour  
JERSEY  
CHANNEL ISLAND  
JE2 7QN

**Order No 78835**

**Order Date** 16/03/2026

**Est. Despatch** //

**A/C Code** CPSU01

**Your Ref** SO17581

**Packaging** Flydor

**Shipping** DX/Channel Islands  
3/5 Day <3m

tamara@cpinteriors.je

Tamara Lopez Domingu/01534768141

am	Code	Description	Qty	Price	Tot
10	MGVS SO17581	Genius 46 Vertical Sprung Operated Retractable Roller Window Screen 1150w x 2050h  Inc. Slow Rise Brake White Frame/Charcoal Mesh 16/03/26 - Size amended  <b>IMPORTANT - PLEASE ADVISE</b> <ul style="list-style-type: none"> <li>◦ Please advise if you want <b>face fixing brackets</b> to be fitted during manufacture - Allow 15mm for fitting</li> <li>◦ OPTION: Slow Close 8366 Brake.</li> <li>◦ OPTION: Reinforcing Pull Bar Handle.</li> <li>◦ OPTION: Tuff Screen pet resistant mesh, (NOT WITH BRAKE).</li> <li>◦ Reveal or Face Fitting.</li> <li>◦ G2605.x PVC Domed (7mm) Cover Caps for Side Guides.</li> <li>◦ <b>NOT RECOMMENDED FOR COMMERCIAL KITCHEN USE.</b></li> </ul> <div style="border: 1px solid red; padding: 5px; width: fit-content; margin: 10px auto;">Food Hygiene - <a href="#">Regulations.</a></div> <p style="text-align: center;"><a href="#">Click for more information :MGVS</a></p>	1.00	151.50	151.5
20	MGVS SO17581	Tariff/Origin:- 7610100000/UK Genius 46 Vertical Sprung Operated Retractable Roller Window Screen 890w x 2060h	1.00	138.70	138.7

1885

BOTH FACE FIX  
CHANGES REQUESTED

Item Code	Description	Qty	Price	Total
	#1 Inc. Slow Rise Brake			
	White Frame/Charcoal Mesh			
	16/03/26 - Size amended			
	Tariff/Origin:- 7610100000/UK			
Estimated 8kgs.				
	VAT No: GB 831 9321 38		Total £	290.2
	EORI No: GB831932138000		Carriage/P&P £	50.0
	Tariff Summary:-		Sub Total £	340.2
	7610100000\***290.20		VAT @0.00%	0.0
	Total £290.20		Order Total £	340.2
	INCO Terms:- DAP			

**PLEASE SIGN ALL DETAILS ARE CORRECT & OK TO PROCEED.**

**OR  
REPLY TO THIS EMAIL.**

**PRINT NAME : .....**

**DATE OF CONFIRMATION : .....**

**OFFICE HOURS:**  
**Oct - Mar** 08:30 to 16:00.  
**Apr - Sep** 08:30 to 17:00.  
 Lunch 13:00-13:30, ☎ close at 16:00.



**New 2026 Price List**  
 Effective **2nd Feb 2026**  
**WhatsApp:**  
**07572 975 582**



Flydor Limited. Priory Works. Newton Street. Newton St Faith, Norwich. Norfolk. NR10 3AD. England.  
 Tel. +44 (0)1603 897 799

Web: [www.flydor.co.uk](http://www.flydor.co.uk)  
 Registered in England No. 4946756

## QUOTATION

o:-  
amara Lopez Domingu  
  
P Interiors  
  
amara@cpinteriors.je

Address:-  
CP Interiors  
Rue Des Pres Trading Estate  
St Saviour  
JERSEY  
CHANNEL ISLANDS  
JE2 7QN

Quote No: **28098**  
Quote Date: 13/02/2026  
A/C Code: CPSU01  
Your Ref: SO17581  
Deliver To: JE2 7QN  
Shipping Method: DX/Channel Islands 3/5  
Day <3m 8Kgs

Item	Product	Qty	Width	Height	Description	Total
05M	MGVS 	1	1070	2050	Genius 46 Vertical Sprung Operated Retractable Roller Window Screen Tariff/Origin:- 7610100000/UK 3.84Kgs #1:Inc. Slow Rise Brake  <ul style="list-style-type: none"> <li>o OPTION: Slow Close 8366 Brake.</li> <li>o OPTION: Reinforcing Pull Bar Handle.</li> <li>o OPTION: Tuff Screen pet resistant mesh, (NOT WITH BRAKE).</li> <li>o Reveal or Face Fitting.</li> <li>o G2605.x PVC Domed (7mm) Cover Caps for Side Guides.</li> <li>o <b>NOT RECOMMENDED FOR COMMERCIAL KITCHEN USE.</b></li> </ul> <div style="border: 1px solid black; padding: 5px; text-align: center; margin: 10px 0;">Food Hygiene - Regulations.</div> <p style="text-align: center; margin: 10px 0;"><a href="#">Click for more information :MGVS</a></p> <p>White Frame/Charcoal Mesh</p>	149.0
06M	MGVS	1	810	2020	Genius 46 Vertical Sprung Operated Retractable Roller Window Screen Tariff/Origin:- 7610100000/UK 3.36Kgs #1:Inc. Slow Rise Brake  White Frame/Charcoal Mesh	135.0

£422  
+ £50

£388





# Flydor

FIRST  
for Flyscreen Technology

## QUOTATION

o:-  
amara Lopez Domingu  
  
P Interiors  
  
amara@cpinteriors.je

Address:-  
CP Interiors  
Rue Des Pres Trading Estate  
St Saviour  
JERSEY  
CHANNEL ISLANDS  
JE2 7QN

Quote No: **28098**  
Quote Date: 13/02/2026  
A/C Code: CPSU01  
Your Ref: SO17581  
Deliver To: JE2 7QN  
Shipping Method: DX/Channel Islands 3/5  
Day <3m 8Kgs

Item	Product	Qty	Width	Height	Description	Total
05M	MGVS 	1	1070	2050	Genius 46 Vertical Sprung Operated Retractable Roller Window Screen Tariff/Origin:- 7610100000/UK 3.84Kgs #1:Inc. Slow Rise Brake  <ul style="list-style-type: none"> <li>o OPTION: Slow Close 8366 Brake.</li> <li>o OPTION: Reinforcing Pull Bar Handle.</li> <li>o OPTION: Tuff Screen pet resistant mesh, (NOT WITH BRAKE).</li> <li>o Reveal or Face Fitting.</li> <li>o G2605.x PVC Domed (7mm) Cover Caps for Side Guides.</li> <li>o <b>NOT RECOMMENDED FOR COMMERCIAL KITCHEN USE.</b></li> </ul> <div style="border: 1px solid black; padding: 5px; text-align: center; margin: 10px 0;">Food Hygiene - <u>Regulations</u></div> <p style="text-align: center; margin: 10px 0;"><a href="#">Click for more information :MGVS</a></p> <p><b>White Frame/Charcoal Mesh</b></p>	149.00
06M	MGVS	1	810	2020	Genius 46 Vertical Sprung Operated Retractable Roller Window Screen Tariff/Origin:- 7610100000/UK 3.36Kgs #1:Inc. Slow Rise Brake  <b>White Frame/Charcoal Mesh</b>	135.30

£422  
+£50

Item	Product	Qty	Width	Height	Description	Price	Notes
<p><b>All measurements are in mm, Width x Height.</b>  <b>Size is the finished overall frame size excluding fittings.</b>  <b>No adjustments or allowances are made by Flydor.</b>  <b>No fixings supplied to fix screen in place.</b>  <b>White frames/charcoal mesh unless otherwise stated.</b>  <b>*VAT, If applicable, charged at rate on day of invoice.</b></p> <p><b>This supply only quotation is valid for 28 days.</b></p>							
						<b>Total £</b>	<b>284.3</b>
						<b>Shipping £</b>	<b>50.0</b>
						<b>Sub Total £</b>	<b>334.3</b>
						<b>*VAT @0.00%</b>	<b>0.0</b>
						<b>Quote Total £</b>	<b>334.3</b>

**OFFICE HOURS:**  
**Oct - Mar 08:30 to 16:00.**  
**Apr - Sep 08:30 to 17:00.**  
**Lunch 13:00-13:30, ☎ close at 16:00.**



**New 2026 Price List**  
**Effective 2nd Feb 2026**  
**WhatsApp:**  
**07572 975 582**



Flydor Limited, Priory Works, Newton Street, Newton St Faith, Norwich, Norfolk, NR10 3AD, England.  
 Tel: +44 (0)1603 897 799\*

Web: [www.flydor.co.uk](http://www.flydor.co.uk)  
 Registered in England No. 4946756



# Flydor

FIRST  
for Flyscreen Technology

## QUOTATION

o:-  
amara Lopez Domingu

P Interiors

amara@cpinteriors.je

Address:-  
CP Interiors  
Rue Des Pres Trading Estate  
St Saviour  
JERSEY  
CHANNEL ISLANDS  
JE2 7QN

Quote No: **28098**

Quote Date: 06/02/2026

A/C Code: CPSU01

Your Ref: SO17581



Deliver To: JE2 7QN

Shipping Method: DX/Channel Islands 3/5  
Day <3m 10Kgs

Item	Product	Qty	Width	Height	Description	Total
01 <sub>M</sub>	<u>MGVS</u> 	1	755	1785	Genius 46 Vertical Sprung Operated Retractable Roller Window Screen <i>Tariff/Origin:- 7610100000/UK</i> #1.Inc. Slow Rise Brake #4.Inc. -Intermediate Stops  <ul style="list-style-type: none"> <li>o OPTION: Slow Close 8366 Brake.</li> <li>o OPTION: Reinforcing Pull Bar Handle.</li> <li>o OPTION: Tuff Screen pet resistant mesh, (NOT WITH BRAKE).</li> <li>o Reveal or Face Fitting.</li> <li>o G2605.x PVC Domed (7mm) Cover Caps for Side Guides.</li> <li>o <b>NOT RECOMMENDED FOR COMMERCIAL KITCHEN USE.</b></li> </ul> <div style="border: 1px solid black; padding: 5px; text-align: center;">Food Hygiene - Regulations.</div> <p style="text-align: center;"><a href="#">Click for more information :MGVS</a></p> <div style="background-color: #333; color: white; padding: 10px; text-align: center; margin-top: 10px;">RAL 8014 Sepia Brown</div>	151.00
02 <sub>M</sub>	<u>MGVS</u>	1	750	1785	Genius 46 Vertical Sprung Operated Retractable Roller Window Screen <i>Tariff/Origin:- 7610100000/UK</i>	151.00

£378  
+20

£378  
+20

Item	Product	Qty	Width	Height	Description	Notes
				3.01Kgs	#1 Inc. Slow Rise Brake #4 Inc. -Intermediate Stops	
						
03M	MGVS	1	1020	2050	Genius 46 Vertical Sprung Operated Retractable Roller Window Screen Tariff/Origin:- 7610100000/UK	171.8
				3.77Kgs	#1:Inc. Slow Rise Brake #4:Inc. -Intermediate Stops	£430
						+20
05S	I	1		0.00Kgs	Tariff/Origin:- 0000000000/UK Brown Angle Not In Our Program.	

**All measurements are in mm, Width x Height.  
Size is the finished overall frame size excluding fittings.  
No adjustments or allowances are made by Flydor.  
No fixings supplied to fix screen in place.  
White frames/charcoal mesh unless otherwise stated.  
\*VAT, If applicable, charged at rate on day of invoice.**



**This supply only quotation is valid for 28 days.**

Total £	473.8
Shipping £	50.0
Sub Total £	523.8
*VAT @0.00%	0.0
Quote Total £	523.8

**OFFICE HOURS:**  
Oct - Mar 08:30 to 16:00.  
Apr - Sep 08:30 to 17:00.  
Lunch 13:00-13:30, ☎ close at 16:00.



**New 2026 Price List**  
Effective 2nd Feb 2026

Flydor Limited. Priory Works. Newton Street. Newton St Faith, Norwich. Norfolk. NR10 3AD. England.  
Tel: +44 (0)1603 897 799

**New 2026 Price List**  
Effective 2nd Feb 2026  
Web: [www.flydor.co.uk](http://www.flydor.co.uk)  
Registered in England No. 4946756



# Genius Product Guide



**KEEP FLIES OUT!**





# GENIUS RETRACTABLE SCREEN

*The Genius is a fully cassetted retractable screen, manufactured with Extruded Powder Coated Aluminium profiles. The screen mesh neatly retracts from view making this screen discreet. Window and door applications available, designed for domestic and light commercial use. Face or reveal fitted both internally or externally.*

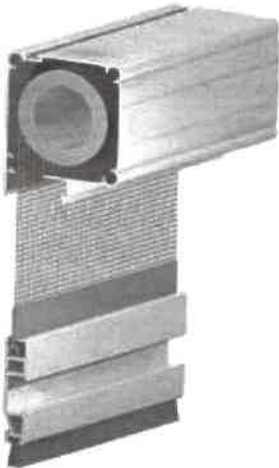

The Genius Window with its compact 46mm box cassette is a versatile retractable screen. Various optional control models are available to suit the most demanding of applications. The screen is neatly held in place with catches concealed in the side channels, and the mesh retracts almost out of sight when not in use. A soft close brake can be fitted to the sprung operation models. (Not Tuff Mesh options). The SLS model allows the screen to be held in two positions, ideal for top and bottom opening windows.

Window models available:

- MGVS** – Sprung only
- MGV** – SLS -Sprung with additional shoot bolts.
- MGVCS** – Chain and Sprung
- MGV**– Chain only

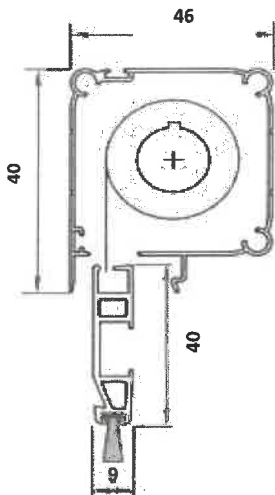

The **Genius Door (MGH46)** is available in both single and double door options. Ideal for use with existing French doors, simple to install and easy to maintain. Soft close brakes are fitted as standard to all our Genius door models, except those using the TUFF Mesh option. Strong magnetic strip closure.

Door Models Available:

- MGH46** – Horizontal single door
- MGH46-2** – Horizontal double door.



*All Genius models (except Blackout) are fitted with our standard FR Fibreglass (18x16) charcoal mesh. Other mesh options are available. Supplied in White, Brown or Black from stock, other RAL colours available. Please contact sales for further details.*

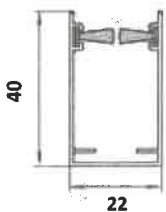

Side guide (Window)  
Top guide (Door)

*\* 80 both*

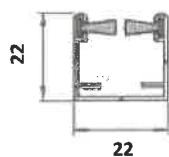

Bottom Guide (Door)

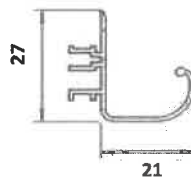

Reinforced pull  
bar handle.

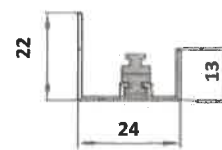

Magnetic Closure  
Channel

## GENIUS BLACKOUT SCREEN

*The Genius Blackout window is a fully cassetted retractable screen, manufactured with Extruded Powder Coated Aluminium profiles. The screen fabric neatly retracts from view making this screen discreet. Designed for domestic and light commercial use. Internal face or recess fitting.*

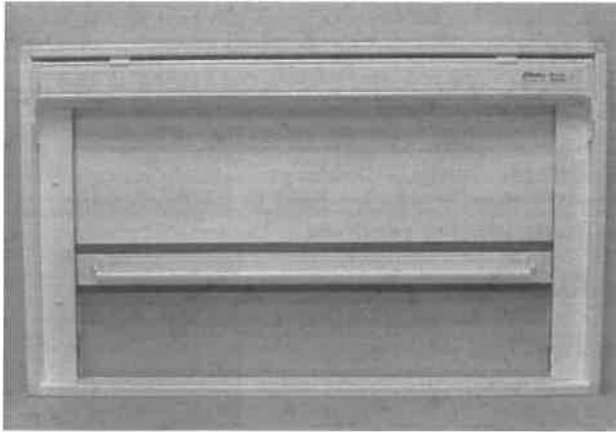

*(Sample screen model shown)*

The Genius Window Blackout with its compact 46mm box cassette is a versatile retractable Blackout screen. Various optional control models are available to suit the most demanding of applications.

The screen is neatly held in place either with catches concealed in the side channels, or a magnetic closure bottom channel. The screen retracts almost out of sight when not in use. A soft close brake can be fitted to the sprung only model if required. Designed for both the commercial and domestic environments.

The Genius Blackout material is manufactured from 4 Ply Blackout Fibreglass laminated to 3 layers of vinyl PVC which provides 100% opacity (full technical specifications available upon request). Available in the following colours:



White.



Camel.



Champagne.

Window models available:

**MGVCSBO** – Chain and Sprung.

**MGVCSBOM**-Chain and Sprung with mag channel closure.

**MGVSBO** – Sprung only.

White or Brown finishes as standard. Special option RAL colours are available.  
Please contact our Sales Team for further details.

## Genius Codes and Specifications.

Product	Code	Standard Specifications	Options (POR)
Genius Door Single <i>Rec Max Size</i> <i>W = 1200mm</i> <i>H = 2300mm</i>	<b>MGH46</b>	<ul style="list-style-type: none"> <li>Single Extruded Powder Coated Aluminium (46 x 46mm) Cassette.</li> <li>Extruded Powder Coated Aluminium top (40mm) and bottom (22mm) channels.</li> <li>Full height Powder Coated Aluminium magnetic closure channel.</li> <li>Surface mounted PVC handles (rigid front and folding back).</li> <li>Soft close brake.</li> <li>Face fitting and recess brackets. <i>Allow 15mm for face fitting</i></li> <li>Spring tensioned Fibreglass (18x16) Charcoal Mesh.</li> <li>White or Brown finish.</li> </ul>	<ul style="list-style-type: none"> <li><i>Tuff Mesh and Midge Mesh.</i></li> <li><i>Anti Wind Pile.</i></li> <li><i>Re-inforced bar profile handle.</i></li> <li><i>7mm Cover caps.</i></li> <li><i>RAL colours.</i></li> </ul>
Double <i>Rec Max Size</i> <i>W = 2400mm</i> <i>H = 2300mm</i>	<b>MGH46-2</b>	<ul style="list-style-type: none"> <li>As above with Double Extruded Powder Coated Aluminium (46 x 46mm) Box Cassettes.</li> <li>Spring loaded internal PVC sliding shoot bolts.</li> <li>Full height magnetic strip closure .</li> </ul>	
Spring Only <i>Rec Max size</i> <i>W = 1800mm</i> <i>H = 2400mm</i>	<b>MGVS</b>	<ul style="list-style-type: none"> <li><i>Extruded Powder Coated Aluminium (46 x 46mm) Cassette.</i></li> <li><i>Spring tensioned Fibreglass (18x16) Charcoal Mesh.</i></li> <li><i>Extruded Powder Coated Aluminium (40 x 22mm) side guide channels.</i></li> <li><i>RH side chain operation (with safety devices).</i></li> <li><i>Single surface mounted PVC handle to pull bar.</i></li> <li><i>Concealed catches for side channels.</i></li> <li><i>Face fitting and recess brackets. Allow 15mm for face fitting</i></li> <li><i>Fibreglass (18x16) Charcoal mesh.</i></li> <li><i>White or Brown Finish.</i></li> </ul>	<ul style="list-style-type: none"> <li><i>Tuff Mesh and Midge Mesh.</i></li> <li><i>Better Vue Mesh*</i></li> <li><i>Anti Wind Pile.</i></li> <li><i>Re-inforced bar profile handle.</i></li> <li><i>7mm Cover caps.</i></li> <li><i>LH Chain operation.</i></li> <li><i>RAL colours.</i></li> </ul>
Chain -Spring <i>Rec Max Size</i> <i>W = 2000mm</i> <i>H = 2500mm</i>	<b>MGVCS</b>	<ul style="list-style-type: none"> <li><i>As MGVS with RH Chain control.</i></li> </ul>	
SLS <i>Rec Max size</i> <i>W = 1600mm</i> <i>H = 1700mm</i>	<b>MGV-SLS</b>	<ul style="list-style-type: none"> <li><i>As MGVS with Spring Loaded Locking Handle System. (SLS)</i></li> </ul>	
Chain Only <i>Rec Max Size</i> <i>W = 1800mm</i> <i>H = 2500mm</i>	<b>MGV</b>	<ul style="list-style-type: none"> <li><i>As MGVS with RH Chain control only NO Spring.</i></li> </ul>	

\* Please note max drop of Better Vue Mesh = 1700mm

## Genius Codes and Specifications.

Product	Code	Standard Specifications	Options (POR)
Genius Window BLACKOUT Spring Rec Max Size W = 1800mm H = 2200mm	<b>MGVSBO</b>	<ul style="list-style-type: none"> <li>Extruded Powder Coated Aluminium (46 x 46mm) Box Cassette.</li> <li>Extruded Powder Coated Aluminium (40 x 22mm) side guide channels.</li> <li>Surface mounted PVC handles to pull bar. (x 2).</li> <li>Concealed catches for side channels.</li> <li>Face fitting and recess brackets. Allow 15mm for face fitting and 5mm for recess fitting.</li> <li>Tensioned White Ex-Lite fabric.</li> <li>White or Brown Finish</li> </ul>	<ul style="list-style-type: none"> <li>7mm Cover caps.</li> <li>LH chain operation.</li> <li>Champagne and Camel Ex-Lite fabrics.</li> <li>Re-inforced bar profile handle.</li> <li>RAL colours</li> </ul>
Chain & Spring	<b>MGVCSBO</b>	<ul style="list-style-type: none"> <li>As above with RH side chain operation (with safety devices).</li> </ul>	
Chain & Spring	<b>MGVCSBOM</b>	<ul style="list-style-type: none"> <li>As MGVCSBO with Powder coated magnetic (25mm) closure channel.</li> </ul>	

### Genius (46) Profile (Not to scale)

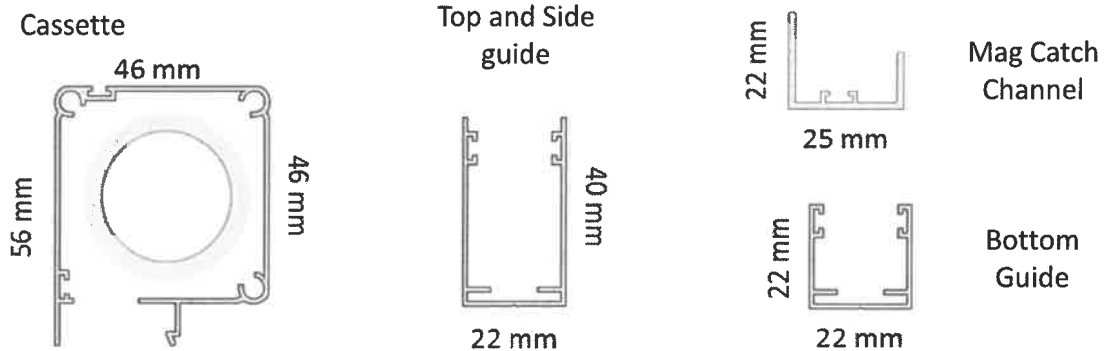

## Measuring Guide. Genius Window.

Please take note before you measure;  
Screens are manufactured to **SCREEN SIZE** (edge of frame to edge of frame excluding fittings). FLYDOR do not make any adjustments or allowances. All Measurements are in mm. Sizes to be supplied as Width x Height.

### WIDTH

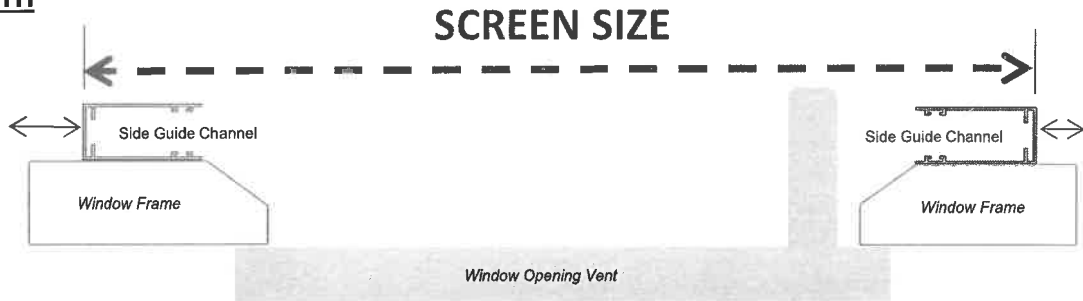

(Birds eye view illustrated - Minimum width shown, side guides can be positioned to suit).

### HEIGHT



Face Fixing L Bracket



Recess Fixing M Clip

Face Fitting without sill.

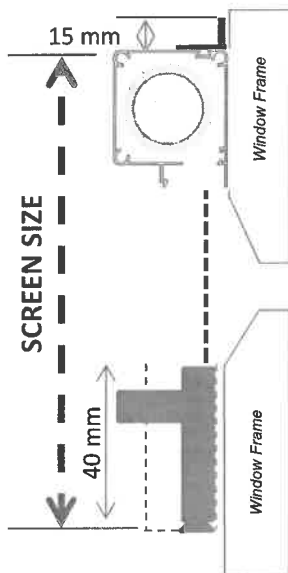

Face Fitting with sill.

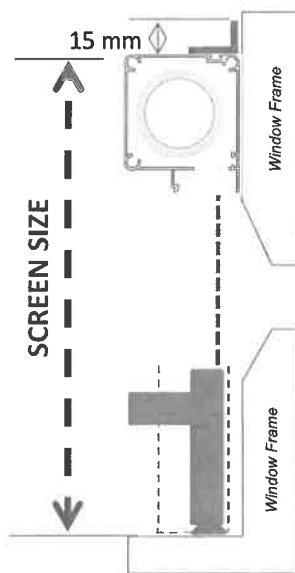

Recess Fitting with or without sill.

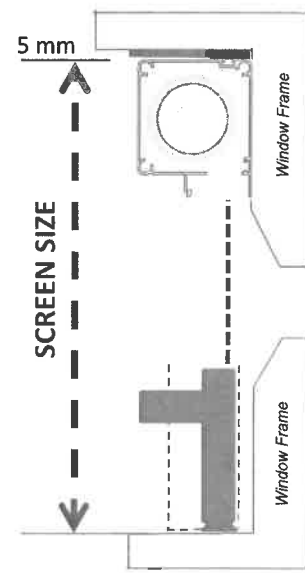

(Please note where no sill is present, an additional bottom channel will be required to provide a seal.)

**Genius Profile**  
(Not to scale)

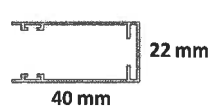
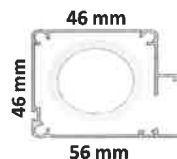

Please take note before you measure;  
Screens are manufactured to SCREEN SIZE (edge of frame to edge of frame excluding fittings). FLYDOR do not make any adjustments or allowances. All Measurements are in mm. Sizes to be supplied as Width x Height.

### WIDTH

#### Single Door (Face Fitting)



(Birds eye view illustrated - Minimum width shown, side guide and cassette can be positioned to suit).

#### Double Door (Face Fitting)

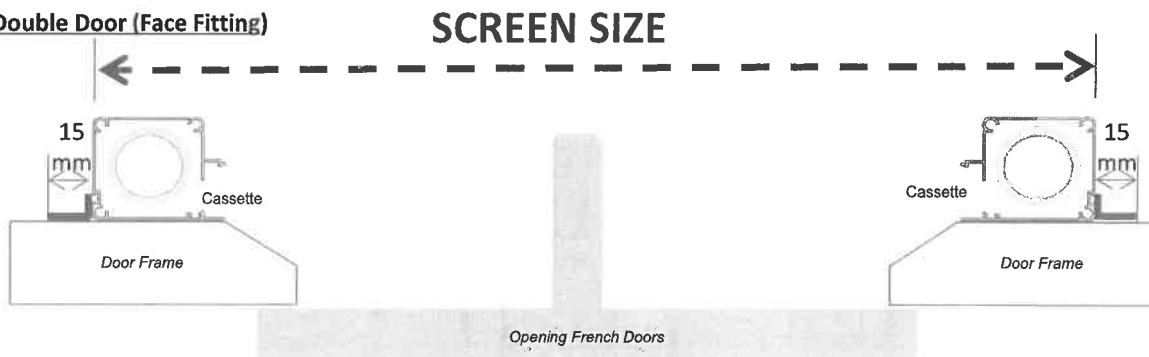

(Birds eye view illustrated - Minimum width shown, cassettes can be positioned to suit).

**Important** ; When measuring please remember the shoot bolts will normally be fitted to the cassette which corresponds to the slave door ie. The door which is not used as the main thoroughfare. Please state which side you would like the shoot bolts to be fitted to.

### WIDTH

#### Recess Fitting Width

If using the cassette fixing "m" clips allow 5mm for fitting.

**Tip** - If the inner handle(s) on the screen is catching the door frame, the top and bottom guides can easily be cut down on site to reduce the width accordingly.

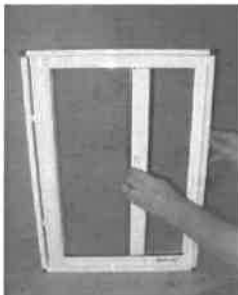

### HEIGHT

#### Height Measurement (All types)

The height is from the top edge to bottom edge of the cassette.

**Tip** - This measurement is critical! Watch out for plinths and any lips which are common with UPVC doors. Allow yourself at least 5mm if fitting into a recess.



# Installation Guide

## Genius Window Screens (All MGV- models)

**Step 1** Before proceeding, decide which of fitting options you wish to use and prepare the side guides prior to assembling the unit.

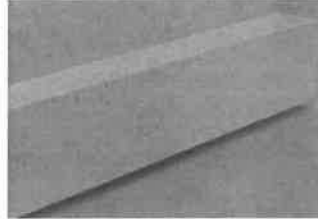
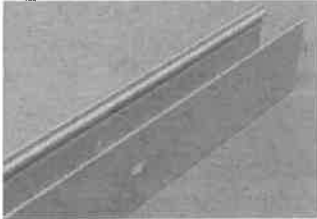

**FACE FITTING Option A** Drill directly through the guide using a 3mm bit. 15mm in from the outer edge. Open the front facing hole to 7mm and use the cover caps provided for a neat finish.

*(Tip) Use a small screw (3.5x 16) to affix to frame.*

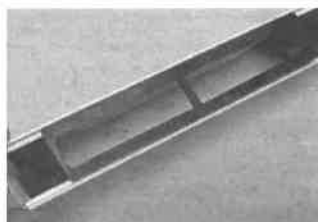
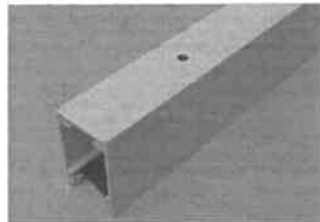

**RECESS FITTING Option B** Drill 3.5 mm holes through the sides of guides, for directly fixing into the recess. Typically two or three depending on height.

*(Tip) Use the special tool 8460.0 to allow the fluffy pile to be safely moved when fitting.*

### Step 2 Fitting the Concealed Catches to the side guides.

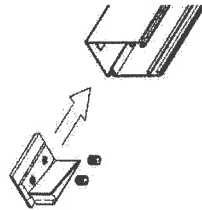
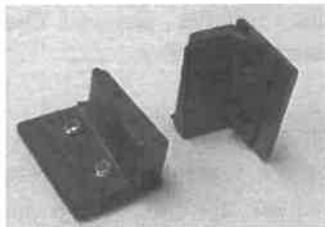

**OPTIONAL INTERMEDIATE STOPS.** If using the optional intermediate stops, slide into the guide ensuring the “wedge” is to the (grooved) front of the side guide. Leave loose, adjust to desired height once the screen has been installed.

*(Tip) Gently does it! Avoid overtightening the grub screws when adjusting. This can cause damage to the side guide and failure to work properly*

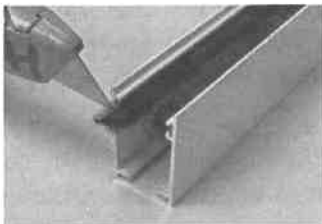

To avoid the fluffy pile being pulled back into the cassette during use. Trim about 6mm off the length of the pile. Simply crimp the channel top and bottom with a flat headed screwdriver and hammer.

*(Tip) Gently does it! Avoid bending the guide out of shape by hitting too hard.*

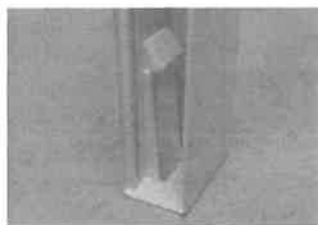
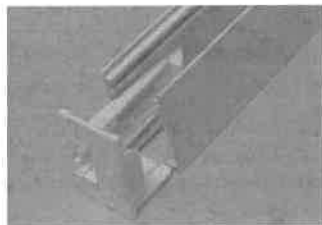

Slide the catches (marked L or R) into the appropriate guide as shown. Ensure the hook is to the front (guides are shown with no pile for illustration purposes)

### Step 3 Preparing the Cassette prior to assembling the unit.



**FACE FITTING** Slide the face fitting L into the groove on the top of the cassette .



**RECESS FITTING** Insert the additional fluffy pile into the groove in the top of the cassette. The **M** bracket is directly fixed to the top of the recess and the cassette simply clicks in place .

#### Step 4 Assembling the unit prior to fitting.



Push the side guides into place ensuring the lugs are correctly located. There should be no gaps as per pic 2.

#### Step 5 Installation of the unit.



**FACE FITTING** Offer the screen against the frame, ensure the screen is square, then mark the fixing points. Carefully drill the pilot holes. Loosely fit the screen in place using suitable screws. Check operation of screen, before tightening.

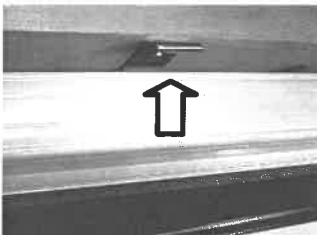

**RECESS FITTING** Offer the screen into the recess, ensure the screen is square, then mark the fixing points for M clips. Remove the screen, Directly fit the M Clips to the top of recess. Click the screen into place. Mark the fixing points for side guides. Directly fix the side guides with suitable screws and fittings if required.



**CHAIN CONTROL OPERATION** Directly fix the chain retaining catch either in the recess or outside the recess.

#### **Important information.**

When using the *Genius Chain Control* screen, a suitable chain safety device(s) must be fitted. Both the Recess and Face Fitting devices are supplied along with the Chain Break as standard.

#### Step 6 Operation of the unit.

To operate the screen. Pull down smoothly and simply clip into place. To open, **TILT** the bottom bar to release from catches . Allow the screen to fully retract back into its cassette housing. .

## Installation Guide

## Genius Door Screens (All MGH & MGH-2 models)

Please read through before commencing.

### Step 1 Preparing the top and bottom guides.

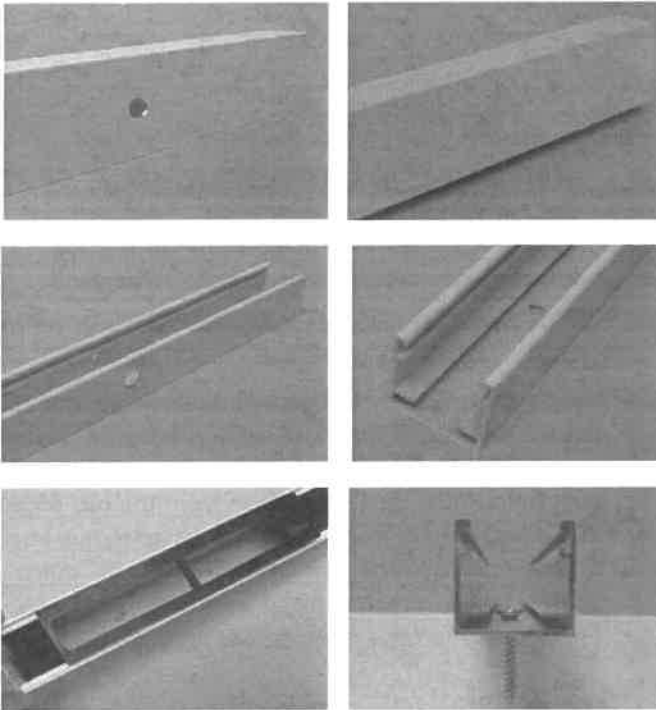

**FACE FITTING** Drill directly through the front and back of the guides using a 3mm bit. **TO AVOID THE PULL BAR FOULING** it is advisable that the holes in the bottom bar are 12mm up from the bottom edge. Alternatively the bottom guide can be affixed using double sided tape. Open the front facing holes to 7mm and use the cover caps provided for a neat finish.

*(Tip) Use a small screw (3.5x 16) to affix to frame.*

**RECESS FITTING** Drill 3.5 mm holes through the bottom of guides, for directly fixing into the recess. Typically two or three depending on height.

*(Tip) Use the special tool 8460.0 to allow the fluffy pile to be safely moved when fitting.*

### Step 2 Securing the Fluffy pile

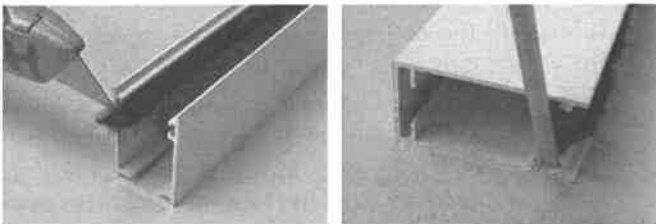

To avoid the fluffy pile being pulled back into the cassette during use. Trim about 6mm off the length of the pile. Simply crimp the channel at each end with a flat headed screwdriver and hammer. *(Tip) Gently does it! Avoid bending the guide out of shape by hitting too hard.*

### Step 3 Preparing the Cassette(s) prior to assembling the unit.

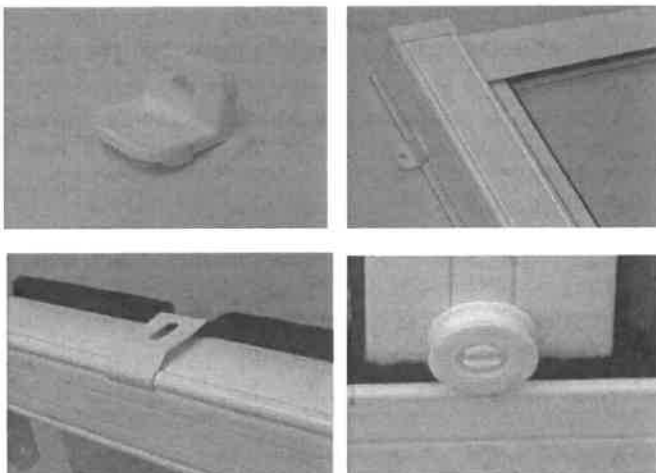

**FACE FITTING** Slide the face fitting L into the groove on the top of the cassette .

**RECESS FITTING** Insert the additional fluffy pile into the groove in the top of the cassette. The M bracket is directly fixed to the side of the recess and the cassette simply clicks in place .

*(Tip) it is virtually impossible to use the M clips when recess fitting the double doors!*

**Attention:** The guide wheel sits on the bottom channel only. This applies to both single and double door models. The screen will not work correctly if fitted "upside" down , and any damage will not be covered under warranty

#### Step 4 Preparing the Magnetic Catch Channel (Single Door).

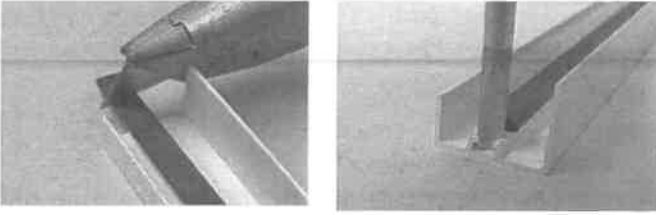

Snip off a small piece of the magnet. Crimp both ends as shown to secure the strip in place.

#### Step 5 Assembling the unit prior to fitting.

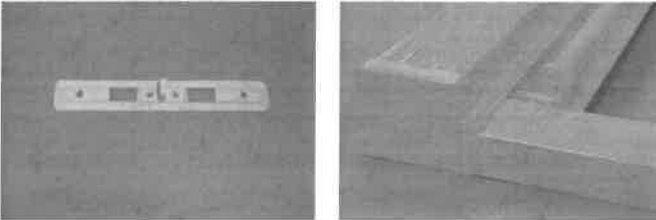

(Double Doors) Ensure the shoot bolt catches are fitted into the top and bottom guides. Do not tighten yet!

Push the guides into place ensuring the lugs are correctly located. There should be no gaps.

#### Step 6 Installation of the unit.

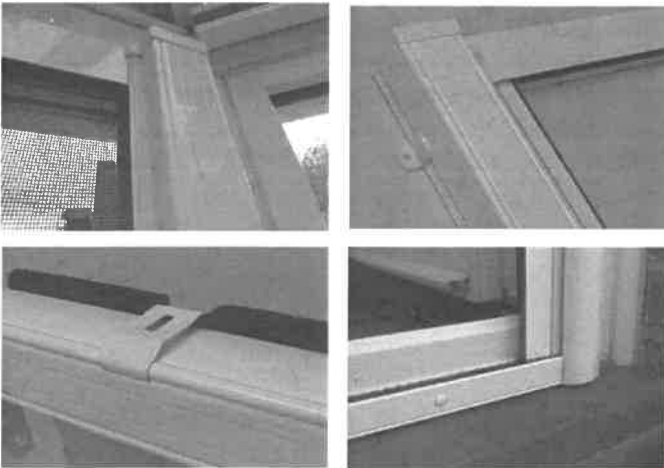

**FACE FITTING** Offer the screen against the frame, ensure the screen is square, then mark the fixing points. Carefully drill the pilot holes. Top guide pilot holes must be 15mm down from the top edge of the profile. The bottom guide pilot holes must be 12mm up from the bottom edge of the guide. Loosely fit the screen in place using suitable screws. Check operation of screen, before tightening.

**RECESS FITTING (Single Door)** Offer the screen into the recess, ensure the screen is square, then mark the fixing points for M clips. Remove the screen, Directly fit the M Clips to the side of recess. Click the screen into place. Mark the fixing points for the channels and Mag Channel. Directly fix the screen with suitable screws and fittings as required. **(Double Door)** As long as the top and bottom guides are securely fixed in place, the cassettes can simply be "butt" fitted to the recess sides

#### Step 7 Shoot Bolt Catch (Double Door) Adjustment

**DOUBLE DOOR.** With the screen in place, slide the Shoot Bolt catches in the channels until the lug is dead centre in the top and bottom guides. Secure in place by tightening the grub screw, be careful not to over tighten.

#### **Maintenance:**

*To keep your screen in perfect working order please keep the guides free from debris and dirt. Should you need to clean the mesh, open the screen fully and simply lightly sponge with a mild cleaning agent and allow to dry before retracting. Simply wipe the framework with a damp soapy cloth and dry with a towel.*

To Operate the screens . **Single Door and window** Gently pull the screen across/down to the mag catch channel.  
**Double Door** bring the slave door over to the centre of the screen and secure in place with the shoot bolts. The main door pulls across to the slave door and is held in place by the magnetic strips. To open, break the magnetic seal by gently pulling the handle towards you. **Do not pull "apart"** The Mesh will then gently retract back into its cassette.

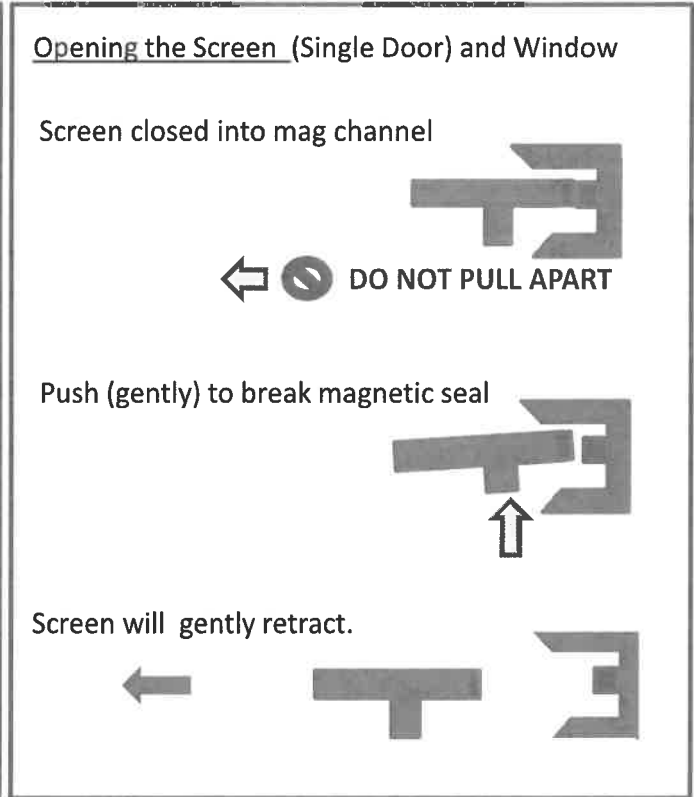
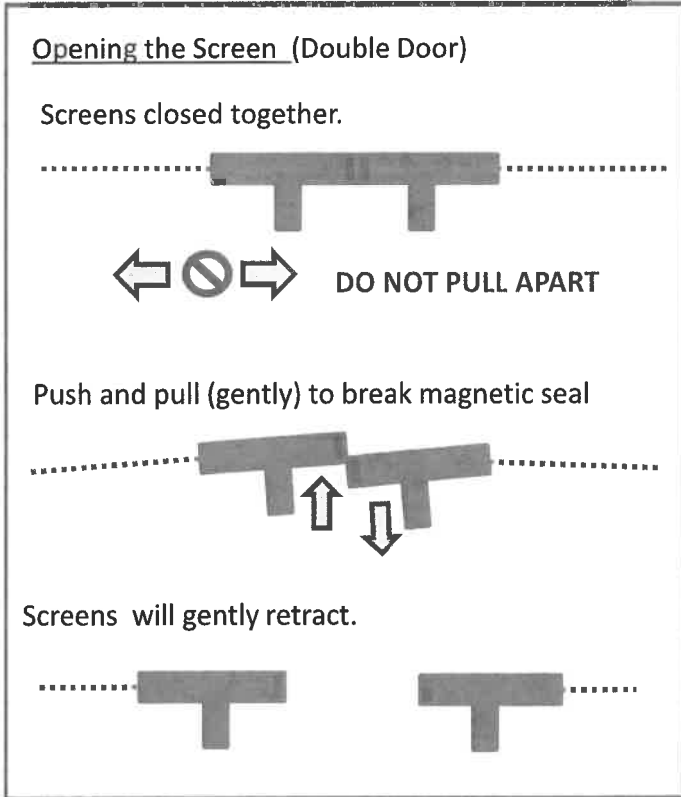



Location	Qty	Type	Width	Drop	Blind/recess	Fabric 1	Fabric 2	Operation
Large Living Room W1	1	BB11	865	1615	B/S	Elan Duotone Papyrus 0161		Hand
Large Living Room W2	1	BB11	970	2035	B/S	Elan Duotone Papyrus 0161		Hand
Large Living Room W3	1	BB11	970	2035	B/S	Elan Duotone Papyrus 0161		Hand
Large Living Room W4	1	BB11	865	1615	B/S	Elan Duotone Papyrus 0161		Hand
Kitchen W1	1	BB11	595	1620	B/S	Elan Duotone Papyrus 0161		Hand
Kitchen W2	1	BB11	595	1620	B/S	Elan Duotone Papyrus 0161		Hand
Kitchen W3	1	BB11	575	1720	B/S	Elan Duotone Papyrus 0161		Hand
Kitchen W4	1	BB11	785	1720	B/S	Elan Duotone Papyrus 0161		Hand
Kitchen W5	1	BB11	790	1720	B/S	Elan Duotone Papyrus 0161		Hand
Kitchen W6 *	1	BB31	1020	2040	B/S	Elan Duotone Papyrus 0161	Batiste Sheer Full Tone Papyrus 0161	Hand
Kitchen W7*	1	BB31	1020	2040	B/S	Elan Duotone Papyrus 0161	Batiste Sheer Full Tone Papyrus 0161	Hand
Kitchen W8	1	BB11	790	1720	B/S	Elan Duotone Papyrus 0161		Hand
Kitchen W9	1	BB11	790	1720	B/S	Elan Duotone Papyrus 0161		Hand
Kitchen W10	1	BB11	575	1720	B/S	Elan Duotone Papyrus 0161		Hand

BB checked ✓

Kitchen W11	1	BB11	595	✓	1620	B/S	Elan Duotone Papyrus 0161		Hand
Kitchen W12	1	BB11	595	✓	1620	B/S	Elan Duotone Papyrus 0161		Hand
Kitchen Single Door	1	BB11	620	✓	2040	B/S	Elan Duotone Papyrus 0161		Hand
Small Upstairs TV Room W1	1	BB11	805	✓	1955	B/S	Elan Duotone Papyrus 0161		Hand
Small Upstairs TV Room W2	1	BB11	805	✓	1955	B/S	Elan Duotone Papyrus 0161		Hand
Main Bedroom W1	1	BB11	810	✓	1960	B/S	Batiste Sheer Full Tone Papyrus 0161		Hand
Main Bedroom W2	1	BB11	810	✓	1960	B/S	Batiste Sheer Full Tone Papyrus 0161		Hand
Main Bedroom W3	1	BB11	945	✓	915	B/S	Batiste Sheer Full Tone Papyrus 0161		Hand
Main Bedroom W4	1	BB11	945	✓	915	B/S	Batiste Sheer Full Tone Papyrus 0161		Hand

**Magnolia hardware for all.**

\*If possible with two handles due to width.

# MASTERBLINDS

SPECIALIST MANUFACTURERS TO THE TRADE

## Quotation

Delivery Method	DATE	NO.
Delivery DX	18-02-2026	ON090612

Master Blinds  
Unit 8, Greenlea Park  
Prince Georges Road  
Merton, SW19 2JD  
Tel : 020 8648 6008

<b>TO</b>
CP Interiors Rue Des Pres Trading Estate St Saviour Jersey JE2 7QN

Cust. Acc. No.	P.O. No.	TERMS
CP001	Powell	28th of next month

DESCRIPTION	QTY	RATE	AMOUNT
To Supply 1 Cellular - Standard - Side Window Blind Large Living Room W1, 865, 1615 , Recess Size, 32mm - Elan DuoTone, Papyrus 0161, BB11 - Band B, EOS Spring Clip Top Fix Brackets, Hardware Colour T.B.C.	1	140.00	140.00 <del>£350</del>
To Supply 1 Cellular - Standard - Side Window Blind Large Living Room W2, 970, 2035 , Recess Size, 32mm - Elan DuoTone, Papyrus 0161, BB11 - Band B, EOS Spring Clip Top Fix Brackets, Hardware Colour T.B.C.	1	172.00	172.00 <del>£430</del>
To Supply 1 Cellular - Standard - Side Window Blind Large Living Room W3, 970, 2035 , Recess Size, 32mm - Elan DuoTone, Papyrus 0161, BB11 - Band B, EOS Spring Clip Top Fix Brackets, Hardware Colour T.B.C.	1	172.00	172.00 <del>£430</del>
To Supply 1 Cellular - Standard - Side Window Blind Large Living Room W4, 865, 1615 , Recess Size, 32mm - Elan DuoTone, Papyrus 0161, BB11 - Band B, EOS Spring Clip Top Fix Brackets, Hardware Colour T.B.C.	1	140.00	140.00 <del>£350</del>
To Supply 1 Cellular - Standard - Side Window Blind Kitchen W1, 595, 1620 , Blind Size, 32mm - Elan DuoTone, Papyrus 0161, BB11 - Band B, EOS Spring Clip Top Fix Brackets, Hardware Colour T.B.C.	1	100.00	100.00 <del>£290</del>
To Supply 1 Cellular - Standard - Side Window Blind Kitchen W2, 590, 1620 , Blind Size, 32mm - Elan DuoTone, Papyrus 0161, BB11 - Band B, EOS Spring Clip Top Fix Brackets, Hardware Colour T.B.C.	1	100.00	100.00 <del>£270</del>
To Supply 1 Cellular - Standard - Side Window Blind Kitchen W3, 570, 1720 , Blind Size, 32mm - Elan DuoTone, Papyrus 0161, BB11 - Band B, EOS Spring Clip Top Fix Brackets, Hardware Colour T.B.C.	1	100.00	100.00 <del>£270</del>
To Supply 1 Cellular - Standard - Side Window Blind Kitchen W4, 785, 1720 , Blind Size, 32mm - Elan DuoTone, Papyrus 0161, BB11 - Band B, EOS Spring Clip Top Fix Brackets, Hardware Colour T.B.C.	1	125.00	125.00 <del>£313</del>
To Supply 1 Cellular - Standard - Side Window Blind Kitchen W5, 785, 1720 , Blind Size, 32mm - Elan DuoTone, Papyrus 0161, BB11 - Band B, EOS Spring Clip Top Fix Brackets, Hardware Colour T.B.C.	1	125.00	125.00 <del>£313</del>
To Supply 1 Cellular - Night & Day - Side Window Blind Kitchen W6, 1020, 2040 , Blind Size, 32mm - Elan DuoTone, Papyrus 0161, BB31 - Night and Day - Band B, EOS Spring Clip Top Fix Brackets, Hardware Colour T.B.C.	1	188.00	188.00 <del>£470</del>
To Supply 1 Cellular - Night & Day - Side Window Blind Kitchen W6, 1020, 2040 , Blind Size, 32mm - Batiste Sheer FullTone, Papyrus 0161, BB31 - Night and Day - Band D+10%, EOS Spring Clip Top Fix Brackets, Hardware Colour T.B.C.	1	388.30	388.30 <del>£971</del>
To Supply 1 Cellular - Night & Day - Side Window Blind Kitchen W7, 1020, 2040 , Blind Size, 32mm - Elan DuoTone, Papyrus 0161, BB31 - Night and Day - Band B, EOS Spring Clip Top Fix Brackets, Hardware Colour T.B.C.	1	188.00	188.00 <del>£470</del>
To Supply 1 Cellular - Night & Day - Side Window Blind Kitchen W7, 1020, 2040 , Blind Size, 32mm - Batiste Sheer FullTone, Papyrus 0161, BB31 - Night and Day - Band D+10%, EOS Spring Clip Top Fix Brackets, Hardware Colour T.B.C.	1	388.30	388.30 <del>£971</del>
To Supply 1 Cellular - Standard - Side Window Blind Kitchen W8, 785, 1720 , Blind Size, 32mm - Elan DuoTone, Papyrus 0161, BB11 - Band B, EOS Spring Clip Top Fix Brackets, Hardware Colour T.B.C.	1	125.00	125.00 <del>£313</del>
To Supply 1 Cellular - Standard - Side Window Blind Kitchen W9, 785, 1720 , Blind Size, 32mm - Elan DuoTone, Papyrus 0161, BB11 - Band B, EOS Spring Clip Top Fix Brackets, Hardware Colour T.B.C.	1	125.00	125.00 <del>£313</del>

144  
144

# MASTERBLINDS

SPECIALIST MANUFACTURERS TO THE TRADE

Delivery Method	DATE	NO.
Delivery DX	18-02-2026	ON090612

Master Blinds  
 Unit 8, Greenlea Park  
 Prince Georges Road  
 Merton, SW19 2JD  
 Tel : 020 8648 6008

TO
CP Interiors Rue Des Pres Trading Estate St Saviour Jersey JE2 7QN

Cust. Acc. No.	P.O. No.	TERMS
CP001	Powell	28th of next month

DESCRIPTION	QTY	RATE	AMOUNT
To Supply 1 Cellular - Standard - Side Window Blind Kitchen W10, 570, 1720 , Blind Size, 32mm - Elan DuoTone, Papyrus 0161,BB11 - Band B, EOS Spring Clip Top Fix Brackets, Hardware Colour T.B.C.	1	100.00	100.00 <i>£220</i>
To Supply 1 Cellular - Standard - Side Window Blind Kitchen W11, 595, 1620 , Blind Size, 32mm - Elan DuoTone, Papyrus 0161,BB11 - Band B, EOS Spring Clip Top Fix Brackets, Hardware Colour T.B.C.	1	100.00	100.00 <i>£220</i>
To Supply 1 Cellular - Standard - Side Window Blind Kitchen W12, 590, 1620 , Blind Size, 32mm - Elan DuoTone, Papyrus 0161,BB11 - Band B, EOS Spring Clip Top Fix Brackets, Hardware Colour T.B.C.	1	100.00	100.00 <i>£220</i>
To Supply 1 Cellular - Standard - Side Window Blind Kitchen Single Door, 620, 2040 , Blind Size, 32mm - Elan DuoTone, Papyrus 0161,BB11 - Band B, EOS Spring Clip Top Fix Brackets, Hardware Colour T.B.C.	1	128.00	128.00 <i>£320</i>
To Supply 1 Cellular - Standard - Side Window Blind Small Upstairs TV Room W1, 700, 2040 , Blind Size, 32mm - Elan DuoTone, Papyrus 0161,BB11 - Band B, EOS Spring Clip Top Fix Brackets, Hardware Colour T.B.C.	1	128.00	128.00 <i>£320</i>
To Supply 1 Cellular - Standard - Side Window Blind Small Upstairs TV Room W2, 700, 2040 , Blind Size, 32mm - Elan DuoTone, Papyrus 0161,BB11 - Band B, EOS Spring Clip Top Fix Brackets, Hardware Colour T.B.C.	1	128.00	128.00 <i>£320</i>
To Supply 1 Cellular - Standard - Side Window Blind Main Bedroom W1, 802, 1970 , Blind Size, 32mm - Batiste Sheer FullTone, Papyrus 0161,BB11 - Band D+10%, EOS Spring Clip Top Fix Brackets, Hardware Colour T.B.C.	1	301.40	301.40 <i>£754</i>
To Supply 1 Cellular - Standard - Side Window Blind Main Bedroom W2, 802, 1970 , Blind Size, 32mm - Batiste Sheer FullTone, Papyrus 0161,BB11 - Band D+10%, EOS Spring Clip Top Fix Brackets, Hardware Colour T.B.C.	1	301.40	301.40 <i>£754</i>
To Supply 1 Cellular - Standard - Side Window Blind Main Bedroom W3, 945, 915 , Blind Size, 32mm - Batiste Sheer FullTone, Papyrus 0161,BB11 - Band D+10%, EOS Spring Clip Top Fix Brackets, Hardware Colour T.B.C.	1	193.60	193.60 <i>£484</i>
To Supply 1 Cellular - Standard - Side Window Blind Main Bedroom W4, 945, 915 , Blind Size, 32mm - Batiste Sheer FullTone, Papyrus 0161,BB11 - Band D+10%, EOS Spring Clip Top Fix Brackets, Hardware Colour T.B.C.	1	193.60	193.60 <i>£484</i>

Notes:

	<b>List Price</b>	4,250.60
<b>VAT SUMMARY</b>		
	<b>SUB TOTAL</b>	4,250.60
	<b>VAT TOTAL</b>	0.00
	<b>TOTAL</b>	<b>4,250.60</b>

BB11: Tensioned to Rail		
	Min Width	150mm
	Max Width	1500mm
	Max Drop	2300mm
Duotone Maximum Area		3m <sup>2</sup>
Room Darkening Maximum Area		2.5m <sup>2</sup>

Everywhere.

Adrian mentioned the possibility of fitting them upside down to open from top.

\* Large Living Room : they might go back to free-hanging smartcord, so please check with Mr Pawell.

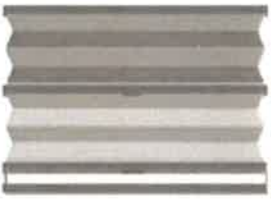
BB31: Tensioned to Rail		
	Min Width	250mm
	Max Width	1200mm
	Max Drop	2300mm
Maximum Area		2m <sup>2</sup>

Kitchen Double Doors

→ Please let client know this supplier uses the exact same hardware as Luxaflex.



Magnolia Hardware

Quantity

Location	Qty	Type	Width	Drop	Blind/recess	Fabric 1	Fabric 2	Operation
Large Living Room W1	1	BB11	865	1615	Approx.	HD Elan Duo 9310		Hand
Large Living Room W2	1	BB11	970	2035	Approx.	HD Elan Duo 9310		Hand
Large Living Room W3	1	BB11	970	2035	Approx.	HD Elan Duo 9310		Hand
Large Living Room W4	1	BB11	865	1615	Approx.	HD Elan Duo 9310		Hand
Kitchen W1	1	BB11	595	1620	B/S	HD Elan Duo 9310		Hand
Kitchen W2	1	BB11	590	1620	B/S	HD Elan Duo 9310		Hand
Kitchen W3	1	BB11	570	1720	B/S	HD Elan Duo 9310		Hand
Kitchen W4	1	BB11	785	1720	B/S	HD Elan Duo 9310		Hand
Kitchen W5	1	BB11	785	1720	B/S	HD Elan Duo 9310		Hand
Kitchen W6	1	BB31	1020	2040	B/S	HD Elan Duo 9310	HD Batiste Sheer 9199	Hand
Kitchen W7	1	BB31	1020	2040	B/S	HD Elan Duo 9310	HD Batiste Sheer 9199	Hand
Kitchen W8	1	BB11	785	1720	B/S	HD Elan Duo 9310		Hand
Kitchen W9	1	BB11	785	1720	B/S	HD Elan Duo 9310		Hand
Kitchen W10	1	BB11	570	1720	B/S	HD Elan Duo 9310		Hand
Kitchen W11	1	BB11	595	1620	B/S	HD Elan Duo 9310		Hand
Kitchen W12	1	BB11	590	1620	B/S	HD Elan Duo 9310		Hand
Kitchen Single Door	1	BB11	620	2040	B/S	HD Elan Duo 9310		Hand
Small Upstairs TV Room W1	1	BB11	700	2040	B/S	HD Elan Duo 9310		Hand
Small Upstairs TV Room W2	1	BB11	700	2040	B/S	HD Elan Duo 9310		Hand

Main Bedroom W1	1	BB11	802	1970	B/S	HD Batiste Sheer 9199	Hand
Main Bedroom W2	1	BB11	802	1970	B/S	HD Batiste Sheer 9199	Hand
Main Bedroom W3	1	BB11	945	915	B/S	HD Batiste Sheer 9199	Hand
Main Bedroom W4	1	BB11	945	915	B/S	HD Batiste Sheer 9199	Hand

\* The client likes these HD fabrics. If not available, please advise regarding closest match.



# CP INTERIORS

## QUOTE

**To:** Mr & Mrs. Powell  
Langstone House  
Belle Hougue Avenue, La Grande Route Des Sablons  
Grouville  
JE3 9 BL

**Job Number:** SO17581 Q1

**Customer Reference:** Insect Screens

**Quote Date:** Friday 06 Feb 2026

**Deposit required:** £ 732.90

**Your Contact:** Tamara

Our Price Promise to you  
We are so confident our pricing is competitive, that we will beat any written quotation for equivalent product by 5%

**To supply and fit unless otherwise stated.**

Location	Product	Description	Qty	Price
Kitchen W1	Insect Screen	Genius 46 Vertical Sprung operated retractable roller window screen (MGVS), with Sepia Brown RAL 8014 hardware and charcoal mesh. Slow close brake. Hand operation.	1	£ 448.00
Kitchen W2	Insect Screen	Genius 46 Vertical Sprung operated retractable roller window screen (MGVS), with Sepia Brown RAL 8014 hardware and charcoal mesh. Slow close brake. Hand operation.	1	£ 448.00
Living Room	Insect Screen	Genius 46 Vertical Sprung operated retractable roller window screen (MGVS), with Sepia Brown RAL 8014 hardware and charcoal mesh. Slow close brake. Hand operation.	1	£ 500.00

**Terms:** 50% deposit due with order, 50% on completion

**\*\* To go ahead with this quote please make deposit payment. To pay by card call us on 01534 768141 \*\***

Direct Deposit - Sort Code: 60-12-03 Account: 66577772

If you have any queries please call us on 01534 768141 or visit our showroom  
Rue des Pres Trading Estate St Saviour

**\*\* For Our Terms & Conditions of Sale please go to [www.cpinteriors.je](http://www.cpinteriors.je) \*\***

<b>Subtotal</b>	<b>£ 1,396.00</b>
<b>GST</b>	<b>£ 69.80</b>
<b>Total</b>	<b>£ 1,465.80</b>
Paid amount	£ 0.00
<b>Total amount</b>	<b>£ 1,465.80</b>

Please note: This quotation is only valid for acceptance for 7 days. Our estimate does not include any electrical work or additional carpentry work to install the above unless otherwise specified. Please note there is a handling charge on customer own fabric of £7.50 per metre. Due to high costs of labour, pre-arranged missed fitting appointments will be charged on a time-wasted basis. Settlement is due on completion of works and an administration charge of £25 will be added per month if unpaid within 30 days. We reserve the right to charge for design, advice and liaison work carried out should an order not be placed. Goods remain the property of CP Interiors until full settlement is received. Should payment not be received we reserve the right to attend premises during working hours to remove goods and not be required to make good. Our full terms and conditions apply and are available on request.

*Checked by Adrian in office on 06/02/26*





# CP INTERIORS

## QUOTE

**To:** Mr & Mrs. Powell  
Langstone House  
Belle Hougue Avenue, La Grande Route Des Sablons  
Grouville  
JE3 9 BL

**Job Number:** SO17541 Q1

**Customer Reference:** Luxaflex Duette Blinds

**Quote Date:** Wednesday 04 Feb 2026

**Deposit required:** £ 7,138.74

**Your Contact:** Tamara

Our Price Promise to you  
We are so confident our pricing is competitive, that we will beat any written quotation for equivalent product by 5%

### To supply and fit unless otherwise stated.

Location	Product	Description	Qty	Price
		Luxaflex Duette, tensioned to top and bottom rails, with 2 fabrics: opaque and sheer. Hand operation with 2 handles. Price guide based on Elan 25/32mm (Band 1) for opaque fabric and Batiste Sheer (Band 3) for sheer.		
Kitchen W1	Honeycomb/ Pleated blind		1	£ 763.00
Kitchen W2	Honeycomb/ Pleated blind		1	£ 763.00
Kitchen W3	Honeycomb/ Pleated blind		1	£ 763.00
Kitchen W4	Honeycomb/ Pleated blind		1	£ 909.00
Kitchen W5	Honeycomb/ Pleated blind		1	£ 909.00
Kitchen W6	Honeycomb/ Pleated blind		1	£ 1,242.00
Kitchen W7	Honeycomb/ Pleated blind		1	£ 1,242.00
Kitchen W8	Honeycomb/ Pleated blind		1	£ 909.00
Kitchen W9	Honeycomb/ Pleated blind		1	£ 909.00
		Luxaflex Duette, tensioned to bottom rail, with an opaque fabric. Hand operation with 1 handle. Price guide based on Elan 25/32mm (Band 1)		
Kitchen W10	Honeycomb/ Pleated blind		1	£ 343.00
Kitchen W11	Honeycomb/ Pleated blind		1	£ 343.00
Kitchen W12	Honeycomb/ Pleated blind		1	£ 343.00

*Checked by  
Adrian in office on  
06/04/26*

Kitchen Single Door	<b>Honeycomb/ Pleated blind</b>		1	£ 451.00
Small Upstairs TV Room W1	<b>Honeycomb/ Pleated blind</b>		1	£ 451.00
Small Upstairs TV Room W2	<b>Honeycomb/ Pleated blind</b>		1	£ 451.00
Luxaflex Duette, free-hanging, with a sheer fabric. Manually operated with a side Smartcord Price guide based on Batiste Sheer 25/32mm (Band 3) .				
Large Living Room W1	<b>Honeycomb/ Pleated blind</b>	Left-hand side control	1	£ 915.00
Large Living Room W2	<b>Honeycomb/ Pleated blind</b>	Left-hand side control	1	£ 1,015.00
Large Living Room W3	<b>Honeycomb/ Pleated blind</b>	Right-hand side control	1	£ 1,015.00
Large Living Room W4	<b>Honeycomb/ Pleated blind</b>	Right-hand side control	1	£ 915.00
Luxaflex Duette, tensioned to top and bottom rails, with a sheer fabric. Operated with a handle. Price guide based on Batiste Sheer 25/32mm (Band 3) .				
Main Bedroom W1	<b>Honeycomb/ Pleated blind</b>		1	£ 685.00
Main Bedroom W2	<b>Honeycomb/ Pleated blind</b>		1	£ 685.00
Main Bedroom W3	<b>Honeycomb/ Pleated blind</b>		1	£ 488.00
Main Bedroom W4	<b>Honeycomb/ Pleated blind</b>		1	£ 488.00

**Terms:** 40% deposit due with order, 40% on delivery & final 20% on completion

**\*\* To go ahead with this quote please make deposit payment. To pay by card call us on 01534 768141 \*\***

Direct Deposit - Sort Code: 60-12-03 Account: 66577772

If you have any queries please call us on 01534 768141 or visit our showroom Rue des Pres Trading Estate St Saviour

**\*\* For Our Terms & Conditions of Sale please go to [www.cpinteriors.je](http://www.cpinteriors.je) \*\***

<b>Subtotal</b>	<b>£ 16,997.00</b>
<b>GST</b>	<b>£ 849.85</b>
<b>Total</b>	<b>£ 17,846.85</b>
Paid amount	£ 0.00
<b>Total amount</b>	<b>£ 17,846.85</b>

Please note: This quotation is only valid for acceptance for 7 days. Our estimate does not include any electrical work or additional carpentry work to install the above unless otherwise specified. Please note there is a handling charge on customer own fabric of £7.50 per metre. Due to high costs of labour, pre-arranged missed fitting appointments will be charged on a time-wasted basis. Settlement is due on completion of works and an administration charge of £25 will be added per month if unpaid within 30 days. We reserve the right to charge for design, advice and liaison work carried out should an order not be placed. Goods remain the property of CP Interiors until full settlement is received. Should payment not be received we reserve the right to attend premises during working hours to remove goods and not be required to make good. Our full terms and conditions apply and are available on request.



**SQ26.000056** New

Total Price **£15,914.00**

Created: 02/02/2026

*Based on - Elan (Band 1) for opaque (translucent)  
- Batiste Sheer (Band 3) (sheer)*

Customer

Search by name, email or phone number...

Internal comments

Valid Until Date

Supplier Instruction ⓘ

Reference 1















SO17541 Powell









Reference 2

*-42.7%      x 2.5  
-10%*

### Lines

Number	Article/Product ID/ Description	Reference	Status	Price variables	Price calculations	Price incl. VAT
1	 1032-1035 Luxaflex Duette 2025		New	Quantity 1 <b>£763</b> Price Per Unit £591.67 VAT High 20%	Price exc. VAT £591.67 VAT £118.33	£710.00
Price exc. VAT						

2		1032-1035 Luxaflex Duette 2025	New	Quantity 1 763	Price Per Unit £591.67	£591.67 VAT £118.33	£710.00
				VAT High 20%			
3		1032-1035 Luxaflex Duette 2025	New	Quantity 1 763	Price Per Unit £591.67	Price exc. VAT £591.67 VAT £118.33	£710.00
				VAT High 20%			
4		1032-1035 Luxaflex Duette 2025	New	Quantity 1 £909	Price Per Unit £705.00	Price exc. VAT £705.00 VAT £141.00	£846.00
				VAT High 20%			
5		1032-1035 Luxaflex Duette 2025	New	Quantity 1 909	Price Per Unit £705.00	Price exc. VAT £705.00 VAT £141.00	£846.00
				VAT High 20%			
6		1032-1035 Luxaflex Duette 2025	New	Quantity 1 £1,242	Price Per Unit £963.33	Price exc. VAT £963.33 VAT £192.67	£1,156.00
				VAT High 20%			
7		1032-1035 Luxaflex Duette 2025	New	Quantity 1 £1,242	Price Per Unit £963.33	Price exc. VAT £963.33 VAT £192.67	£1,156.00
				VAT High 20%			
8		1032-1035 Luxaflex Duette 2025	New	Quantity 1 £909	Price Per Unit £705.00	Price exc. VAT £705.00 VAT £141.00	£846.00
				VAT High 20%			
9		1032-1035 Luxaflex Duette 2025	New	Quantity 1 £909	Price Per Unit £705.00	Price exc. VAT £705.00 VAT £141.00	£846.00
				VAT High 20%			
10		1032-1035 Luxaflex Duette 2025	New	Quantity 1 £343	Price Per Unit £265.83	Price exc. VAT £265.83 VAT £53.17	£319.00
				VAT High 20%			
11		1032-1035 Luxaflex Duette 2025	New	Quantity 1 £343	Price Per Unit £265.83	Price exc. VAT £265.83 VAT £53.17	£319.00
				VAT High 20%			
12		1032-1035 Luxaflex Duette 2025	New	Quantity 1 £343	Price Per Unit £265.83	Price exc. VAT £265.83 VAT £53.17	£319.00
				VAT High 20%			
13		1032-1035 Luxaflex Duette 2025	New	Quantity 1 £451	Price Per Unit £350.00	Price exc. VAT £350.00 VAT £70.00	£420.00
				VAT High 20%			
14		1032-1035 Luxaflex Duette 2025	New	Quantity 1 £451	Price Per Unit £350.00	Price exc. VAT £350.00 VAT £70.00	£420.00
				VAT High 20%			
15		1032-1035 Luxaflex Duette 2025	New	Quantity 1 £451	Price Per Unit £350.00	Price exc. VAT £350.00 VAT £70.00	£420.00
				VAT High 20%			

			Quantity	Price Per Unit	Price exc. VAT		
16		1032-1035 Luxaflex Duette 2025	New	1 <i>£915</i>	£710.00	£710.00	£852.00
				VAT High 20%		VAT £142.00	
17		1032-1035 Luxaflex Duette 2025	New	1 <i>£1,015</i>	£787.50	£787.50	£945.00
				VAT High 20%		VAT £157.50	
18		1032-1035 Luxaflex Duette 2025	New	1 <i>£1,015</i>	£787.50	£787.50	£945.00
				VAT High 20%		VAT £157.50	
19		1032-1035 Luxaflex Duette 2025	New	1 <i>£915</i>	£787.50	£787.50	£945.00
				VAT High 20%		VAT £157.50	
20		1032-1035 Luxaflex Duette 2025	New	1 <i>£685</i>	£531.67	£531.67	£638.00
				VAT High 20%		VAT £106.33	
21		1032-1035 Luxaflex Duette 2025	New	1 <i>£685</i>	£531.67	£531.67	£638.00
				VAT High 20%		VAT £106.33	
22		1032-1035 Luxaflex Duette 2025	New	1 <i>£488</i>	£378.33	£378.33	£454.00
				VAT High 20%		VAT £75.67	
23		1032-1035 Luxaflex Duette 2025	New	1 <i>£488</i>	£378.33	£378.33	£454.00
				VAT High 20%		VAT £75.67	

Same as  
16

### Order Price Summary

Subtotal Excl. Vat	£13,261.66
Price Before VAT	£13,261.66
20% VAT High 20%	£2,652.34
<b>Total Price</b>	<b>£15,914.00</b>





**SQ26.000059** New

Total Price **£2,114.00**

Created: 13/02/2026 Last Change: 13/02/2026

Customer

Search by name, email or phone number...

Internal comments

Valid Until Date

Supplier Instruction ⓘ

Reference 1

SO17581 Powell

Reference 2

### Lines

Article/Product ID/ Description	Reference	Status	Price variables	Price calculations	Price incl. VAT
1032-1027 Luxaflex Duette 2022		New	Quantity 1 Price Per Unit £424.17 VAT High 20%	Price exc. VAT £424.17 VAT £84.83	£509.00
1032-1027 Luxaflex Duette 2022		New	Quantity 1 Price Per Unit £456.67	Price exc. VAT £456.67	£548.00

*MB*  
*£350*  
*£547*  
*£615*  
*£654*  
*£450*  
*£587*

VAT High 20%

VAT  
£91.33

	Quantity	Price Per Unit	Price exc. VAT	VAT	
1032-1027 3 Luxaflex Duette 2022	1 New £470	£456.67 £589 VAT High 20%	£456.67 £654	£91.33	£548.00
1032-1027 4 Luxaflex Duette 2022	1 New £350	£424.17 £547 VAT High 20%	£424.17 £615	£84.83	£509.00

### Order Price Summary

Subtotal Excl. Vat	£1,761.68
Price Before VAT	£1,761.68
20% VAT High 20%	£352.32
Total Price	£2,114.00



**SQ26.000058** New

Total Price **£10,708.97**

Created: 13/02/2026 Last Change: 13/02/2026

Customer

Search by name, email or phone number...

Internal comments

Valid Until Date

Supplier Instruction ⓘ

Reference 1

SO17541

Reference 2

Powell

### Lines

Article/Product ID/ Description	Reference	Status	Price variables	Price calculations	Price incl. VAT
1032-1027 Luxaflex Duette 2022		New	Quantity 1 Price Per Unit £665.83 VAT High 20%	Price exc. VAT £665.83 VAT £133.17	£799.00
1032-1027 Luxaflex Duette 2022		New	Quantity 1 Price Per Unit £665.83	Price exc. VAT £665.83	£799.00

Handwritten notes and corrections:

- 85.8 (written above Price Per Unit)
- £734 (written next to Status)
- £954 (written next to VAT High 20%)
- £898 (written below Price Per Unit)
- £954 (written below Price Per Unit)

VAT High 20% VAT  
£133.17

~~£858~~  
~~£854~~

1032-1027	Quantity	1	Price Per Unit £665.83	Price exc. VAT £665.83		
3 Luxaflex Duette 2022					VAT £133.17	£799.00
1032-1027	Quantity	1	Price Per Unit £812.50	Price exc. VAT £812.50		
4 Luxaflex Duette 2022					VAT £162.50	£975.00
1032-1027	Quantity	1	Price Per Unit £812.50	Price exc. VAT £812.50		
5 Luxaflex Duette 2022					VAT £162.50	£975.00
1032-1027	Quantity	1	Price Per Unit £1,163.33	Price exc. VAT £1,163.33		
6 Luxaflex Duette 2022					VAT £232.67	£1,396.00
1032-1027	Quantity	1	Price Per Unit £1,163.33	Price exc. VAT £1,163.33		
7 Luxaflex Duette 2022					VAT £232.67	£1,396
1032-1027	Quantity	1	Price Per Unit £812.50	Price exc. VAT £812.50		
8 Luxaflex Duette 2022					VAT £162.50	£975.00
1032-1027	Quantity	1	Price Per Unit £812.50	Price exc. VAT £812.50		
9 Luxaflex Duette 2022					VAT £162.50	£975.00
1032-1027	Quantity	1	Price Per Unit £314.16	Price exc. VAT £314.16		
10 Luxaflex Duette 2022					VAT £62.83	£376.99
1032-1027	Quantity	1	Price Per Unit £314.16	Price exc. VAT £314.16		
11 Luxaflex Duette 2022					VAT £62.83	£376
1032-1027	Quantity	1	Price Per Unit £314.16	Price exc. VAT £314.16		
12 Luxaflex Duette 2022					VAT £62.83	£376.99
1032-1027	Quantity	1	Price Per Unit £407.50	Price exc. VAT £407.50		
13 Luxaflex Duette 2022					VAT £81.50	£489.00

~~£1,048~~  
~~£1,163~~

~~£1,048~~  
~~£1,163~~

~~£1,500~~  
~~£1,666~~

~~£1,500~~  
~~£1,666~~

~~£1,048~~  
~~£1,163~~

~~£1,048~~  
~~£1,163~~

~~£405~~  
~~£450~~

~~£405~~  
~~£450~~

~~£405~~  
~~£450~~

~~£525~~  
~~£589~~

**Order Price Summary**

Subtotal Excl. Vat	£8,924.13
Price Before VAT	£8,924.13
20% VAT High 20%	£1,784.84
<b>Total Price</b>	<b>£10,708.97</b>



# CP INTERIORS

## QUOTE

**To:** Mr & Mrs. Powell  
Langstone House  
Belle Hougue Avenue, La Grande Route Des Sablons  
Grouville  
JE3 9 BL

**Job Number:** SO17602 Q1

**Customer Reference:** Small Upstairs Living Room & Main Bedroom

**Quote Date:** Friday 13 Feb 2026

**Deposit required:** £ 1,939.35

**Your Contact:** Tamara

Our Price Promise to you  
We are so confident our pricing is competitive, that we will beat any written quotation for equivalent product by 5%

### To supply and fit unless otherwise stated.

Location	Product	Description	Qty	Price
Small Upstairs TV Room	Honeycomb/ Pleated blind	Luxaflex Duette, tensioned to bottom rail, with an opaque fabric. Hand operation with 1 handle. Price guide based on Elan Duo 32mm 9310	2	£ 1,050.00
Main Bedroom W1 and W2	Honeycomb/ Pleated blind	Luxaflex Duette, tensioned to bottom rail, with an opaque fabric. Hand operation with 1 handle. Price guide based on Batiste Sheer 32mm 9199.	2	£ 1,520.00
Main Bedroom W3 and W4	Honeycomb/ Pleated blind		2	£ 1,124.00

**Terms:** 50% deposit due with order, 50% on completion

**\*\* To go ahead with this quote please make deposit payment. To pay by card call us on 01534 768141 \*\***

Direct Deposit - Sort Code: 60-12-03 Account: 66577772

If you have any queries please call us on 01534 768141 or visit our showroom Rue des Pres Trading Estate St Saviour

**\*\* For Our Terms & Conditions of Sale please go to [www.cpinteriors.je](http://www.cpinteriors.je) \*\***

<b>Subtotal</b>	<b>£ 3,694.00</b>
<b>GST</b>	<b>£ 184.70</b>
<b>Total</b>	<b>£ 3,878.70</b>
Paid amount	£ 0.00
<b>Total amount</b>	<b>£ 3,878.70</b>

Please note: This quotation is only valid for acceptance for 7 days. Our estimate does not include any electrical work or additional carpentry work to install the above unless otherwise specified. Please note there is a handling charge on customer own fabric of £7.50 per metre. Due to high costs of labour, pre-arranged missed fitting appointments will be charged on a time-wasted basis. Settlement is due on completion of works and an administration charge of £25 will be added per month if unpaid within 30 days. We reserve the right to charge for design, advice and liaison work carried out should an order not be placed. Goods remain the property of CP Interiors until full settlement is received. Should payment not be received we reserve the right to attend premises during working hours to remove goods and not be required to make good. Our full terms and conditions apply and are available on request.





# CP INTERIORS

## QUOTE

**To:**  
Mr & Mrs. Powell  
Langstone House  
Belle Hougue Avenue, La Grande Route Des Sablons  
Grouville  
JE3 9 BL

**Job Number:** SO17541 Q1  
**Customer Reference:**  
Luxaflex Duette Blinds And Insect  
Screens - Kitchen

**Quote Date:** Friday 13 Feb 2026  
**Deposit required:** £ 4,995.48  
**Your Contact:** Tamara

Our Price Promise to you

We are so confident our pricing is competitive, that we will beat any written quotation for equivalent product by 5%

### To supply and fit unless otherwise stated.

Location	Product	Description	Qty	Price
		Luxaflex Duette, tensioned to top and bottom rails, with 2 fabrics: opaque and sheer. Hand operation with 2 handles. Price guide based on Elan 32mm Duo 9310 for opaque fabric and Batiste Sheer 9199.		
Kitchen W1	Honeycomb/ Pleated blind		1	£ 858.00
Kitchen W2	Honeycomb/ Pleated blind		1	£ 858.00
Kitchen W3	Honeycomb/ Pleated blind		1	£ 858.00
Kitchen W4	Honeycomb/ Pleated blind		1	£ 1,048.00
Kitchen W5	Honeycomb/ Pleated blind		1	£ 1,048.00
Kitchen W6	Honeycomb/ Pleated blind		1	£ 1,500.00
Kitchen W7	Honeycomb/ Pleated blind		1	£ 1,500.00
Kitchen W8	Honeycomb/ Pleated blind		1	£ 1,048.00
Kitchen W9	Honeycomb/ Pleated blind		1	£ 1,048.00
		Luxaflex Duette, tensioned to bottom rail, with an opaque fabric. Hand operation with 1 handle. Price guide based on Elan Duo 32mm 9310		
Kitchen W10	Honeycomb/ Pleated blind		1	£ 405.00
Kitchen W11	Honeycomb/Ple ated blind		1	£ 405.00
Kitchen W12	Honeycomb/Ple ated blind		1	£ 405.00

Kitchen Single Door	<b>Honeycomb/ Pleated blind</b>		1	£ 525.00
Living Room	<b>Insect Screen</b>	Genius 46 Vertical Sprung operated retractable roller window screen (MGVS), with white hardware and charcoal mesh. Slow close brake. Hand operation.	1	£ 388.00

**Terms:** 40% deposit due with order, 40% on delivery & final 20% on completion

**\*\* To go ahead with this quote please make deposit payment. To pay by card call us on 01534 768141 \*\***

Direct Deposit - Sort Code: 60-12-03 Account: 66577772

If you have any queries please call us on 01534 768141 or visit our showroom Rue des Pres Trading Estate St Saviour

**\*\* For Our Terms & Conditions of Sale please go to [www.cpinteriors.je](http://www.cpinteriors.je) \*\***

<b>Subtotal</b>	<b>£ 11,894.00</b>
<b>GST</b>	<b>£ 594.70</b>
<b>Total</b>	<b>£ 12,488.70</b>
Paid amount	£ 0.00
<b>Total amount</b>	<b>£ 12,488.70</b>

Please note: This quotation is only valid for acceptance for 7 days. Our estimate does not include any electrical work or additional carpentry work to install the above unless otherwise specified. Please note there is a handling charge on customer own fabric of £7.50 per metre. Due to high costs of labour, pre-arranged missed fitting appointments will be charged on a time-wasted basis. Settlement is due on completion of works and an administration charge of £25 will be added per month if unpaid within 30 days. We reserve the right to charge for design, advice and liaison work carried out should an order not be placed. Goods remain the property of CP Interiors until full settlement is received. Should payment not be received we reserve the right to attend premises during working hours to remove goods and not be required to make good. Our full terms and conditions apply and are available on request.



# CP INTERIORS

## QUOTE

**To:**  
Mr & Mrs. Powell  
Langstone House  
Belle Hougue Avenue, La Grande Route Des Sablons  
Grouville  
JE3 9 BL

**Job Number:** SO17581 Q1  
**Customer Reference:**  
Luxaflex Duette Blinds And Insect  
Screens - Large Living Room

**Quote Date:** Friday 13 Feb 2026  
**Deposit required:** £ 1,440.60  
**Your Contact:** Tamara

Our Price Promise to you

We are so confident our pricing is competitive, that we will beat any written quotation for equivalent product by 5%

**To supply and fit unless otherwise stated.**

Location	Product	Description	Qty	Price
Large Living Room W1	Honeycomb/ Pleated blind	Luxaflex Duette, tensioned to top and bottom with rails, in Elan Duo 9310 fabric and white hardware. Hand operation with a handle.	1	£ 547.00 ✓
Large Living Room W2	Honeycomb/ Pleated blind	Luxaflex Duette, tensioned to top and bottom with rails, in Elan Duo 9310 fabric and white hardware. Hand operation with a handle.	1	£ 589.00 ✓
Large Living Room W3	Honeycomb/ Pleated blind	Luxaflex Duette, tensioned to top and bottom with rails, in Elan Duo 9310 fabric and white hardware. Hand operation with a handle.	1	£ 589.00 ✓
Large Living Room W4	Honeycomb/ Pleated blind	Luxaflex Duette, tensioned to top and bottom with rails, in Elan Duo 9310 fabric and white hardware. Hand operation with a handle.	1	£ 547.00 ✓
Living Room	Insect Screen	Genius 46 Vertical Sprung operated retractable roller window screen (MGVS), with white hardware and charcoal mesh. Slow close brake. Hand operation.	1	£ 472.00 ✓

**Terms:** 50% deposit due with order, 50% on completion

**\*\* To go ahead with this quote please make deposit payment. To pay by card call us on 01534 768141 \*\***

Direct Deposit - Sort Code: 60-12-03 Account: 66577772

If you have any queries please call us on 01534 768141 or visit our showroom Rue des Pres Trading Estate St Saviour

**\*\* For Our Terms & Conditions of Sale please go to [www.cpinteriors.je](http://www.cpinteriors.je) \*\***

<b>Subtotal</b>	<b>£ 2,744.00</b>
<b>GST</b>	<b>£ 137.20</b>
<b>Total</b>	<b>£ 2,881.20</b>
Paid amount	£ 0.00
<b>Total amount</b>	<b>£ 2,881.20</b>

Please note: This quotation is only valid for acceptance for 7 days. Our estimate does not include any electrical work or additional carpentry work to install the above unless otherwise specified. Please note there is a handling charge on customer own fabric of £7.50 per metre. Due to high costs of labour, pre-arranged missed fitting appointments will be charged on a time-wasted basis. Settlement is due on completion of works and an administration charge of £25 will be added per month if unpaid within 30 days. We reserve the right to charge for design, advice and liaison work carried out should an order not be placed. Goods remain the property of CP Interiors until full settlement is received. Should payment not be received we reserve the right to attend premises during working hours to remove goods and not be required to make good. Our full terms and conditions apply and are available on request.





**SQ26.000060** New

Total Price **£3,438.00**

Created: 13/02/2026 Last Change: 13/02/2026

Customer

Search by name, email or phone number...

Internal comments

Valid Until Date

Supplier Instruction ⓘ

Reference 1

SO17602 Powell

Reference 2

### Lines

Article/Product ID/ Description	Reference	Status	Price variables	Price calculations	Price incl. VAT
1032-1027 Luxaflex Duette 2022		New	Quantity 1 Price Per Unit £407.50 VAT High 20%	Price exc. VAT £407.50 VAT £81.50	£489.00
1032-1027 Luxaflex Duette 2022		New	Quantity 1 Price Per Unit £407.50	Price exc. VAT £407.50	£489.00

£525

£525

VAT High 20%

VAT  
£81.50

1032-1027		Quantity	1	Price Per Unit £589.17	<del>£760</del>	Price exc. VAT £589.17	
3 Luxaflex Duette 2022	New			VAT High 20%		VAT £117.83	£707.00
1032-1027		Quantity	1	Price Per Unit £589.17	<del>£760</del>	Price exc. VAT £589.17	
4 Luxaflex Duette 2022	New			VAT High 20%		VAT £117.83	£707.00
1032-1027		Quantity	1	Price Per Unit £435.83	<del>£562</del>	Price exc. VAT £435.83	
5 Luxaflex Duette 2022	New			VAT High 20%		VAT £87.17	£523.00
1032-1027		Quantity	1	Price Per Unit £435.83	<del>£562</del>	Price exc. VAT £435.83	
6 Luxaflex Duette 2022	New			VAT High 20%		VAT £87.17	£523.00

### Order Price Summary

Subtotal Excl. Vat	£2,865.00
Price Before VAT	£2,865.00
20% VAT High 20%	£573.00
<b>Total Price</b>	<b>£3,438.00</b>

Staff Name: Adrian  
 Order No: SO17541  
 Surveyor: Measurer

Contact Address: Powell

Langstone House Belle Hougue Avenue, La Grande Route Des Sablons Grouville JE3 9 BL  
 07797751479 859718

Customer Ref: Tamara

Account Manager: Tamara

Date: 28-01-2026

Time: 15:00 PM

**P10**

Notes: To measure to replace existing blinds with possibly the same (Duette). Also insect screens. Please bring Duette samples.

Location	Supplier	Blind Type / Description	Colour	Qty	Width	Drop	Fitting Height	B or R	Controls	Brackets	Surface	Unit Price
Kitchen	Flydor	Roller Duette		1	785	1785						
u		Screen frames in brown		1	750	1785						
u	<del>luxmax</del> Duette	Duette	Duette	1	595	1620		B	Hand	Tol		
			D	1	590	1620						
			D	1	570	<del>1620</del> 1720						
			D	1	785	1720						
			D	1	785	1720						
			D	2	1020	2040						
			D	2	785	1720						
			S	1	570	1720						
			S	1	595	1620						
Comments:	Dowl 620 x 2040 S											

Surface Fixing:  
 C=Concrete  
 W=Wood  
 M=Metal  
 B=Brick  
 P=Plastic  
 T=Tile

Customer Signature: X  
 I have checked and agree with the above choices  
 Target Fitting Date

Order: 590 1620  
 Quote

D = with opaque & plastic  
 S = just opaque





