



CP INTERIORS

QUOTE



To:
 Jo & Peter Taylor
 Clos Des Pins
 The Avenue
 St Clement
 JE2 6PD

Job Number: SO16673 Q1
Customer Reference:
 OPTION 1 No fascias

Quote Date: Wednesday 12 Nov 2025
Deposit required: £ 1,085.70
Your Contact: Tamara

Our Price Promise to you
 We are so confident our pricing is competitive, that we will beat any written quotation for equivalent product by 5%

To supply and fit unless otherwise stated.

Location	Product	Description	Qty	Price
		OPTION 1 - Battery Operated Roller Blinds with metal bottom bar (no fascia)		
		Roller blind (without fascia) in Perspective 3% (non-silver backed) mesh fabric, in Beige, with a Gemini white metal bottom bar. Operated with a Somfy Sonesse Ultra 30 RTS Li-Ion re-chargeable battery motor.		
				
				
		<i>Reverse roll</i>		
Kitchen W1	Roller blind		1	£ 667.00
Kitchen W2	Roller blind		1	£ 624.00
Kitchen W3	Roller blind		1	£ 667.00
	Accessories	Situo 5 remote and charger	1	£ 110.00

Revised quote including white metal bottom bar

Terms: 50% deposit due with order, 50% on completion

**** To go ahead with this quote please make deposit payment. To pay by card call us on 01534 768141 ****

Direct Deposit - Sort Code: 60-12-03 Account: 66577772

If you have any queries please call us on 01534 768141 or visit our showroom Rue des Pres Trading Estate St Saviour

**** For Our Terms & Conditions of Sale please go to www.cpinteriors.je ****

Subtotal	£ 2,068.00
GST	£ 103.40
Total	£ 2,171.40
Paid amount	£ 0.00
Total amount	£ 2,171.40

Please note: This quotation is only valid for acceptance for 7 days. Our estimate does not include any electrical work or additional carpentry work to install the above unless otherwise specified. Please note there is a handling charge on customer own fabric of £7.50 per metre. Due to high costs of labour, pre-arranged missed fitting appointments will be charged on a time-wasted basis. Settlement is due on completion of works and an administration charge of £25 will be added per month if unpaid within 30 days. We reserve the right to charge for design, advice and liaison work carried out should an order not be placed. Goods remain the property of CP Interiors until full settlement is received. Should payment not be received we reserve the right to attend premises during working hours to remove goods and not be required to make good. Our full terms and conditions apply and are available on request.



Tropical Blinds Ltd

Unit 6 and 7 Five Arches Business Est
off Maidstone Road
Sidcup
Kent DA14 5AE
T: 020 8269 6400
F: 020 8269 6401



tropical
blinds

Order Acknowledgement

Cust Order No : SO16673Q1 TAYLOR
Order Date : 02/12/2025
Order No : 1022131
Account Ref : CPS007
Despatch method : DHL Economy
Delivery Date: 16/12/2025
Carriage Type : DHL Economy Select

Order to :

C.P Interiors
Rue Des Pres Trading Estate
St. Saviour
Jersey
Channel Islands
JE2 7QN

Deliver to :

C.P Interiors 2
Rue Des Pres Trading Estate
St Saviour
Jersey
Channel Islands
JE2 7QN

Type	Colour	Width	Drop	Quantity	Unit Price	Disc %	Net
Roller - Sonesse Ultra 30 RTS/Zigbee LI-ION	Perspective 3% FR Beige 3m R/F (L)	1770	2170	1	257.83	51.92	286.00
40mm Roller Tube, No, Gemini B/Bar - White (Smooth Side Front Facing), Reverse Roll, Blind is safe by design and requires no additional devices or warning labels					37.86		
Sonesse Ultra 30 WF RTS 2nm LI ION Motor, Ultra 30 Charger Plug 4m Cable, Situo 5 RTS Pure II NE, Not Required, No Hub Required					143.84		
Measurement:Blind Size Spec. Ins:							
Install Height: Not Specified Location: Kitchen W1							
Roller - Sonesse Ultra 30 RTS/Zigbee LI-ION	Perspective 3% FR Beige 3m R/F (L)	1600	2170	1	231.15	51.92	227.32
Not Required, 40mm Roller Tube, No, Gemini B/Bar - White (Smooth Side Front Facing), Reverse Roll, Blind is safe by design and requires no additional devices or warning labels					33.66		
Sonesse Ultra 30 WF RTS 2nm LI ION Motor, Not Required, No Hub Required					100.00		
Measurement:Blind Size Spec. Ins:							
Install Height: Not Specified Location: Kitchen W2							
Roller - Sonesse Ultra 30 RTS/Zigbee LI-ION	Perspective 3% FR Beige 3m R/F (L)	1770	2170	1	257.83	51.92	242.16
Not Required, 40mm Roller Tube, No, Gemini B/Bar - White (Smooth Side Front Facing), Reverse Roll, Blind is safe by design and requires no additional devices or warning labels					37.86		
Sonesse Ultra 30 WF RTS 2nm LI ION Motor, Not Required, No Hub Required					100.00		
Measurement:Blind Size Spec. Ins:							
Install Height: Not Specified Location: Kitchen W3							

If a Premium-carriage service is requested (Pre Noon, Pre 10.30, Saturday or Saturday Pre Noon) the relevant charge will be applied to your invoice. Goods delivered to the following areas: Cornwall, Dyfed, Powys, Anglesey, Gwynedd, Scotland, Isle of Wight, Isle of Man, Isle of Scilly, Channel Isles, Northern Ireland and Republic of Ireland will be subject to a carriage charge as detailed on Page 2 of our trade price list. These carriage charges may not appear on your Proforma invoice or Order acknowledgement but will be applied to your invoice

Net Price :	£755.48
VAT :	£0.00
Total :	£755.48

Tropical Blinds Ltd

Quotation
Customer Copy

Unit 6 and 7 Five Arches Business Est
off Maidstone Road
Sidcup
Kent
DA14 5AE
Tel: 020 8269 6400 Fax: 020 8269 6401

Vat No: 324 0532 02
Cust Order No: SO16673 TAYLOR
Order Date: 01/12/2025
Order No: 5169305
Cust Ref:
Account Ref: CPS007
Despatch Method:DHL Economy

Order To:
C.P Interiors 2
Rue Des Pres Trading Estate
St Saviour
Jersey
Channel Islands
JE2 7QN

Deliver To:
C.P Interiors 2
Rue Des Pres Trading Estate
St Saviour
Jersey
Channel Islands
JE2 7QN

Type	Colour	Width	Drop	Quantity	Unit Price	Disc %	Net
1. Roller - Sonesse Ultra 30 RTS/Zigbee LI-IONPerspective 3% FR Beige 3m R/F (L)1770			2170	1	257.83	51.92	286.00
Sonesse Ultra 30 WF RTS 2nm LI ION Motor, Ultra 30 Charger Plug 4m Cable, Situo 5 RTS Pure II NE, Not Required, No Hub Required, 40mm Roller Tube, No Headbox Required, No Brackets Required, Gemini B/Bar - White (Shaped Side Front Facing), No Scallop, No Braid Required, No Pole, No Finial, No Eyelets Required, Reverse Roll, blind is safe by design and requires no additional devices or warning labels Measurement: Blind Size Spec. ins: Location: Kitchen W1 Fitting ins:							181.70
2. Roller - Sonesse Ultra 30 RTS/Zigbee LI-IONPerspective 3% FR Beige 3m R/F (L)1600			2170	1	231.15	51.92	227.32
Sonesse Ultra 30 WF RTS 2nm LI ION Motor, Not Required, No Handset Required, Not Required, No Hub Required, 40mm Roller Tube, No Headbox Required, No Brackets Required, Gemini B/Bar - White (Shaped Side Front Facing), No Scallop, No Braid Required, No Pole, No Finial, No Eyelets Required, Reverse Roll, Blind is safe by design and requires no additional devices or warning labels Measurement: Blind Size Spec. ins: Location: Kitchen W2 Fitting ins:							133.66
3. Roller - Sonesse Ultra 30 RTS/Zigbee LI-IONPerspective 3% FR Beige 3m R/F (L)1770			2170	1	257.83	51.92	242.16
Sonesse Ultra 30 WF RTS 2nm LI ION Motor, Not Required, No Handset Required, Not Required, No Hub Required, 40mm Roller Tube, No Headbox Required, No Brackets Required, Gemini B/Bar - White (Shaped Side Front Facing), No Scallop, No Braid Required, No Pole, No Finial, No Eyelets Required, Reverse Roll, Blind is safe by design and requires no additional devices or warning labels Measurement: Blind Size Spec. ins: Location: Kitchen W3 Fitting ins:							137.86

Net Total: 755.48
VAT: 0.00
Total: 755.48

*shaped is hexagonal side
so opposite of the image on
your quote.*

*→ Tropical changed it
automatically.
it has now been
changed to smooth side
(facing front)*

RB checked ✓

Staff Name Adrian
 Order No SP16673
 Surveyor Measurer

Work Diary.

Contact Address

Mr & Mrs. Jo & Peter, TaylorClos Des Pins, The Avenue, St Clement, JE2 6PD,
 george.taylor21@icloud.com
 Mr & Mrs. Jo & Peter, TaylorClos Des Pins, The Avenue, St Clement, JE2 6PD,
 george.taylor21@icloud.com

Customer Ref

Date 08-04-2025
 Time PM

Notes : ideas for sliding doors x 3 - possible voiles/allusions or sun protection

Location	Supplier	Blind Type /Description	Colour	Qty	Width	Drop	Fitting Height	B or R	Controls	Brackets	Surface	Unit Price
Kitchen		Keller Lion	Screen	1	1770	2170		BR		Fark		
		1 RFS		1	1600	2170						
		OR pair Vule		1	1770	2170						
		Cuiter		1	706	2440						
		double deck			T/W							
		on ceiling										
		Muried VABS										

Comments:

Requested quote from PC 15/04/25

Surface Fixing
 C=Concrete
 W=Wood
 M=Metal
 B=Brick
 P-Plastic
 T=Tile

Order

Customer Signature
 X I have checked and agree with the above choices

Quote

Target Fitting Date

1460
1410



CP INTERIORS

QUOTE

To:
 Jo & Peter Taylor
 Clos Des Pins
 The Avenue
 St Clement
 JE2 6PD

Job Number: SO16673 Q3

Quote Date: Thursday 13 Nov 2025

Customer Reference:

Deposit required: £ 1,553.48

Option 3 Evolve fascia and Luxury 35 hembar

Your Contact: Tamara

Our Price Promise to you

We are so confident our pricing is competitive, that we will beat any written quotation for equivalent product by 5%

To supply and fit unless otherwise stated.

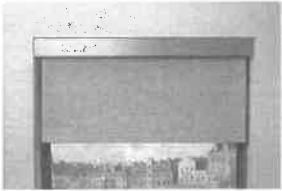
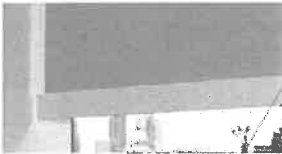
Location	Product	Description	Qty	Price
		OPTION 3 - Battery Operated Roller Blinds with Evolve fascia and Luxury 35 hembar.		
		Roller blind with Evolve white fascia, in Perspective 3% (non-silver backed) mesh fabric, in Beige, with a white Luxury 35 hembar. Operated with a Somfy Sonesse Ultra 30 RTS Li-Ion rechargeable battery motor.		
				Fascia (only for reference)
				Luxury 35 hembar (only for reference)
Kitchen W1	Roller blind		1	£ 952.00
Kitchen W2	Roller blind		1	£ 934.00
Kitchen W3	Roller blind		1	£ 952.00
	Accessories	Situo 5 remote and charger	1	£ 121.00

Revised quote including Evolve fascia and Luxury 35 hembar

Terms: 50% deposit due with order, 50% on completion

Subtotal £ 2,959.00

**** To go ahead with this quote please make deposit payment. To pay by card call us on 01534 768141 ****

GST £ 147.95

Direct Deposit - Sort Code: 60-12-03 Account: 66577772

Total £ 3,106.95

If you have any queries please call us on 01534 768141 or visit our showroom Rue des Pres Trading Estate St Saviour

Paid amount £ 0.00

Total amount £ 3,106.95

** For Our Terms & Conditions of Sale please go to www.cpinteriors.je **

Please note: This quotation is only valid for acceptance for 7 days. Our estimate does not include any electrical work or additional carpentry work to install the above unless otherwise specified. Please note there is a handling charge on customer own fabric of £7.50 per metre. Due to high costs of labour, pre-arranged missed fitting appointments will be charged on a time-wasted basis. Settlement is due on completion of works and an administration charge of £25 will be added per month if unpaid within 30 days. We reserve the right to charge for design, advice and liaison work carried out should an order not be placed. Goods remain the property of CP Interiors until full settlement is received. Should payment not be received we reserve the right to attend premises during working hours to remove goods and not be required to make good. Our full terms and conditions apply and are available on request.



CP INTERIORS

QUOTE

To:
 Jo & Peter Taylor
 Clos Des Pins
 The Avenue
 St Clement
 JE2 6PD

Job Number: SO16673 Q4

Quote Date: Wednesday 12 Nov 2025

Customer Reference:

Deposit required: £ 1,567.65

Option 4 Slim fascia and Gemini white metal bottom bar

Your Contact: Tamara

Our Price Promise to you

We are so confident our pricing is competitive, that we will beat any written quotation for equivalent product by 5%

To supply and fit unless otherwise stated.

Location	Product	Description	Qty	Price
		OPTION 4 - Battery Operated Roller Blinds with 70/100mm Slim fascia and Gemini white metal bottom bar		
		Roller blind with a 70/100mm Slim fascia in White, in Perspective 3% (non-silver backed) mesh fabric, in Beige, with a Gemini white metal bottom bar. Operated with a Somfy Sonesse Ultra 30 RTS Li-Ion re-chargeable battery motor.		
Kitchen W1	Roller blind		1	£ 963.00
Kitchen W2	Roller blind		1	£ 913.00
Kitchen W3	Roller blind		1	£ 963.00
	Accessories	Situo 5 remote and charger	1	£ 147.00

Revised quote including 70/100mm Slim fascias and Gemini white metal bottom bars

Terms: 50% deposit due with order, 50% on completion

Subtotal £ 2,986.00

**** To go ahead with this quote please make deposit payment. To pay by card call us on 01534 768141 ****

GST £ 149.30

Direct Deposit - Sort Code: 60-12-03 Account: 66577772

Total £ 3,135.30

If you have any queries please call us on 01534 768141 or visit our showroom Rue des Pres Trading Estate St Saviour.

Paid amount £ 0.00

Total amount £ 3,135.30

**** For Our Terms & Conditions of Sale please go to www.cpinteriors.je ****

Please note: This quotation is only valid for acceptance for 7 days. Our estimate does not include any electrical work or additional carpentry work to install the above unless otherwise specified. Please note there is a handling charge on customer own fabric of £7.50 per metre. Due to high costs of labour, pre-arranged missed fitting appointments will be charged on a time-wasted basis. Settlement is due on completion of works and an administration charge of £25 will be added per month if unpaid within 30 days. We reserve the right to charge for design, advice and liaison work carried out should an order not be placed. Goods remain the property of CP Interiors until full settlement is received. Should payment not be received we reserve the right to attend premises during working hours to remove goods and not be required to make good. Our full terms and conditions apply and are available on request.

ROLLER SLIM FASCIA SYSTEMS

75mm & 100mm

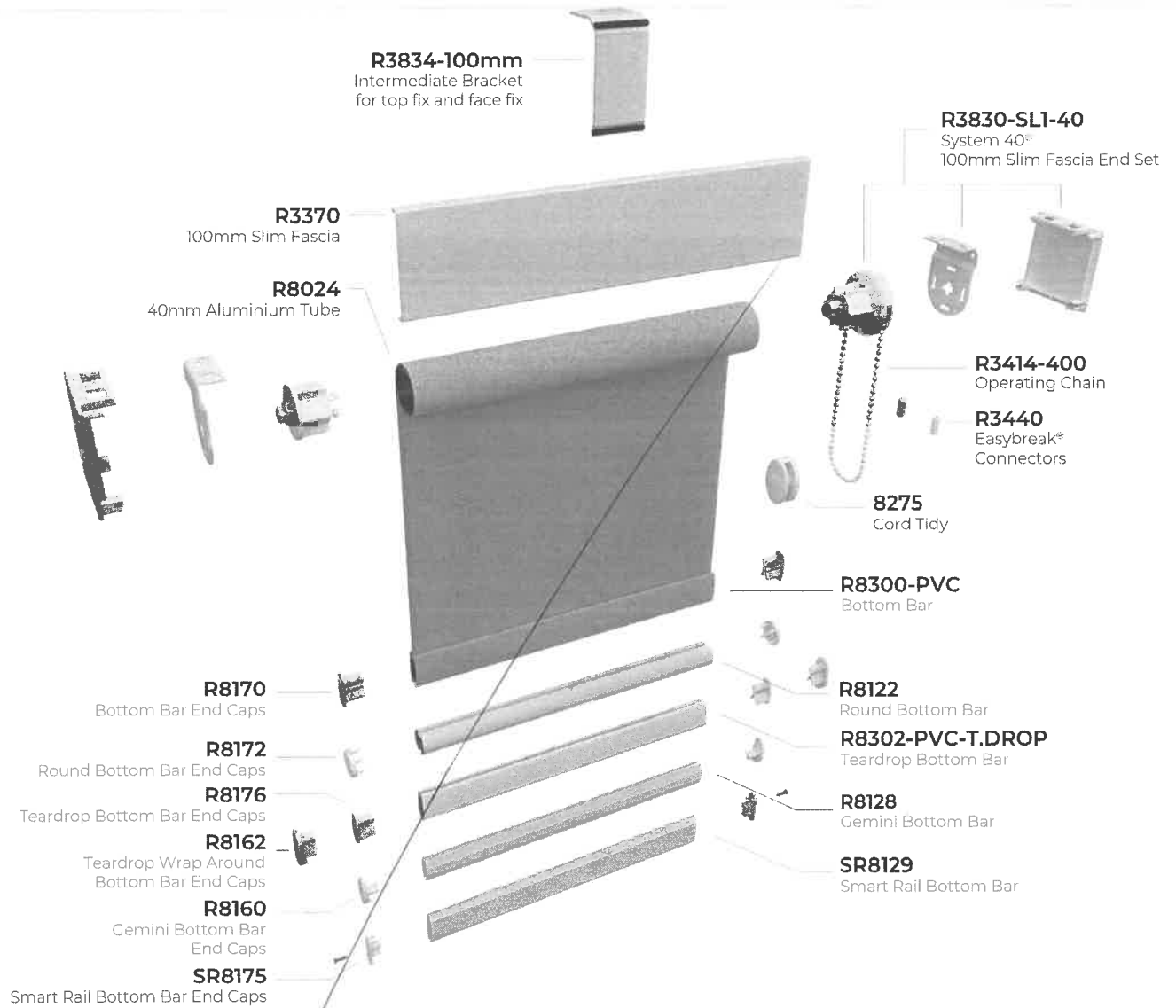

SLIM FASCIA 75mm & 100mm

R3375-75mm Slim Fascia
System 32° and 40°



R3370-100mm Slim Fascia
System 40°, 40+° and 45°



SLIM FASCIA BRACKETS

R3832-SL1-32

75mm Slim Fascia Bracket

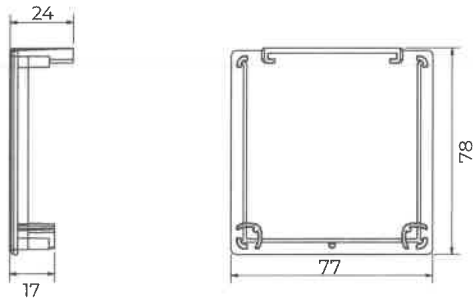

R3830-SL1-40

100mm Slim Fascia Bracket

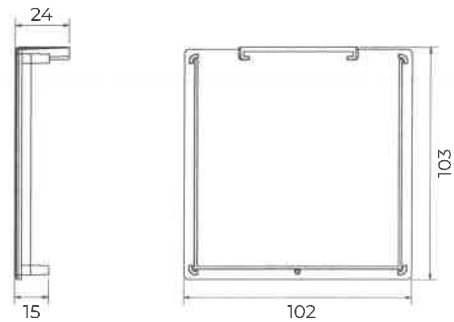

SLIM FASCIA MOTORISED

SYSTEM	MOTOR	OPERATION
System 40®	1100 DC SERIES - R2110 DC	RF Remote Control/Smart Control/BT
	1100 DC-SHORT SERIES - R2115 DC - SHORT	RF Remote Control/Smart Control/BT
System 40®/45®	2000 DC SERIES - R2120 DC	RF Remote Control/Smart Control/BT
	2000 DCM SERIES - R2125 DCM	RF Remote Control/Smart Control/MATTER
	3000 DC SERIES - R2130-DC	RF Remote Control/Smart Control/BT
	3000 DCM SERIES - R2135 DCM	RF Remote Control/Smart Control/MATTER
	2000 AC SERIES - R2150 AC	RF Remote Control/Smart Control/BT
	2000 ACM SERIES - R2155 ACM	RF Remote Control/Smart Control/MATTER

LOUVOLITE SIDE CONTROL SYSTEMS MAXIMUM BLIND SIZE

SYSTEM	FABRIC GROUP	BLIND WIDTH (m) FOR BLIND DROP (m)						40HD	MAX HOLDING WEIGHT
		0.5	1.0	1.5	2.0	2.5	3.0		
								3.0	
System 32® Blue Pin Slim Fascia 75	up to 200g/m sq	4.0	4.0	4.0	4.0				6lb blind at 4mm deflection
	200 > 320g/m sq	3.0	3.0	3.0	3.0				
	320 > 485g/m sq	1.9	1.9	1.9	1.9				
System 32® Red Pin Slim Fascia 75	up to 200g/m sq	4.0	4.0	4.0	4.0				8lb blind at 5mm deflection
	200 > 320g/m sq	3.0	3.0	3.0	3.0				
	320 > 485g/m sq	3.0	3.0	2.5	2.5				
System 35® (Motorised) Slim Fascia 75	up to 200g/m sq	3.0	3.0	3.0	2.0				4lb blind at 4mm deflection
	200 > 320g/m sq	1.7	2.0	2.0	1.5				
	320 > 485g/m sq	1.9	2.0	2.0	1.5				
System 40® Slim Fascia 75	up to 200g/m sq	5.0	5.0	5.0	5.0	5.0		5.0	9lb blind at 6mm deflection
	200 > 320g/m sq	3.75	3.75	3.75	3.75	3.75		3.75	
	320 > 485g/m sq	5.0	5.0	5.0	3.55	2.7		2.1	
System 40+® Slim Fascia 100	up to 200g/m sq	5.0	5.0	5.0	5.0	5.0		5.0	18lb blind at 6mm deflection
	200 > 320g/m sq	3.75	3.75	3.75	3.75	3.75		3.75	
	320 > 485g/m sq	5.0	5.0	5.0	3.55	2.7		2.1	
System 45® Slim Fascia 100	up to 200g/m sq	6.0	6.0	6.0	6.0	6.0	4.5		12lb blind at 9mm deflection
	200 > 320g/m sq	4.75	4.75	4.75	4.75	4.75	2.80		
	320 > 485g/m sq	6.0	6.0	6.0	5.0	4.0	1.85		

Your Louvolite Distributor

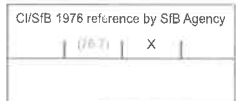

HARDWARE SPECIFICATION

75mm & 100mm Slim Fascia

Roller blinds with a slim fascia are manufactured as per the standard Louvolite System 32® - 45® and include the specially designed aluminium fascia. The mild steel universal brackets are zinc plated and powder coated, suitable for top fixing or face fixing. These locate into the specially designed end caps, which are made using high grade ABS material.

Colour spec: White RAL 9010, Black RAL 9011, Anthracite Grey RAL 7016 and Silver.

The side control units are made from glass filled Nylon 6, with an acetal sprocket and sprocket guard, and includes a locking spring.

The operating chain, No. 10 size in metal or plastic, ensures reliable performance, and improved chain location enables quick and easy on-site adjustment.

A spring plunger end mechanism is positioned at the opposite end to the control unit, providing a more

secure fit of the blind and smooth operation. The side control unit is fitted with a centre plug that ensures the mechanism operates smoothly even under extreme loads.

For blinds over 1500mm the intermediate bracket is required to support the fascia. These are made of mild steel and are silver.

Performance

To ensure a positive performance, all Louvolite roller system units are designed and manufactured in the UK using prime plastic materials and a dedicated steel locking spring.

The sidewinders will lock into the bracket with the unique bracket securing pin for safety after installation.

10 year life cycle testing is done to ensure long lasting performance.

Operation

Using manual or motorised operation, all blinds must be compliant with the child safety elements of BS EN13120. Where children may be present, the chain

must be fitted with easy-break connectors or a cord tidy.

Bottom Bar

Standard, made of aluminium or pvc, can be single or double wrapped in fabric or left exposed, while circular and the dual face Gemini, made of aluminium, only have the fabric formed and locked into the top part to leave the bar exposed. All fabric is formed and held into place with locking tape. The dual face Gemini bar, smooth on one side and angular on the other, improves the ease of manufacture and use of thicker laminate fabrics.

Maintenance

The system components are manufactured using aluminium, treated steel and plastic. They do not present any corrosion problems in normal environments. The system has been designed for a smooth operation, together with a rigidity to prolong the window blind's working life. Manufacturing size restrictions are included in this specification brochure.

NOTES

Tamara Lopez-Dominguez

From: James Cassidy <James@cassidysunblinds.co.uk>
Sent: 06 November 2025 16:43
To: Tamara Lopez-Dominguez
Subject: RE: SO16673 Taylor

Follow Up Flag: Follow up
Flag Status: Flagged

Hi Tamara

No problem, please find revised prices below as requested

Type – Roller
Fabric – Perspective 3%
Colour – White
Power – 12v Battery
Control – RTS
Extra – 70mm/100mm Slim Fascia
Bottom Bar – White Gemini

1No 1770 x 2170 @	£385.00	£963
1No 1600 x 2170 @	£365.00	£913
1No 1770 x 2170 @	£385.00	£963

OR

Type – Roller
Fabric – Perspective 3%
Colour – White
Power – 12v Battery
Control – RTS
Extra – 75mm/100mm Square Fascia
Bottom Bar – White Gemini

1No 1770 x 2170 @	£415.00	£1,038
1No 1600 x 2170 @	£395.00	£988
1No 1770 x 2170 @	£415.00	£1,038

1No Situo 5 @	£45.00	£113
1No Charger @	£13.50	£34

All prices are PLUS VAT
Delivery 10 – 14 days (subject to stock)

Kind regards

James Cassidy
Managing Director
Cassidy's Sunblinds
Unit B Layerthorpe Road
Henry Boot Way
Priory Park
Hull
HU4 7DF
Direct - 01482 330601
Tel - 01482 330600
Fax - 01482 330606
Mobile - 07951760934
Email - james@cassidysunblinds.co.uk

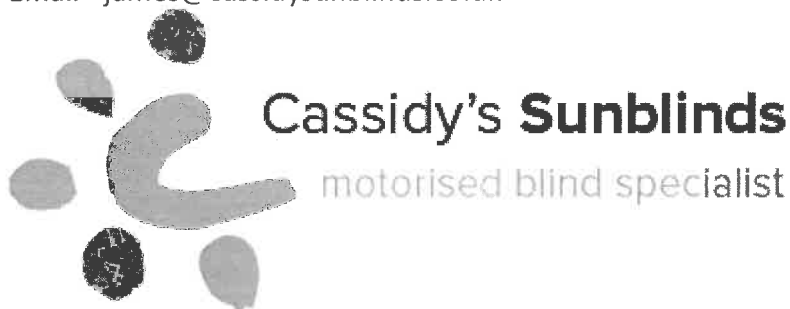

Confidentiality: This e-mail and its attachments are intended for the above named only and may be confidential. If they have come to you in error you must take no action based on them, nor must you copy or show them to anyone; please reply to this e-mail and highlight the error.

Security Warning: Please note that this e-mail has been created in the knowledge that Internet e-mail is not a 100% secure communications medium. We advise that you understand and observe this lack of security when e-mailing us.

Viruses: Although we have taken steps to ensure that this e-mail and attachments are free from any virus, we advise that in keeping with good computing practice the recipient should ensure they are actually virus free and maintain up to date and adequate virus-checking software. We accept no liability for any damage due to virus transmission or infection, however caused.

From: Tamara Lopez-Dominguez <Tamara@cpinteriors.je>
Sent: 06 November 2025 15:45
To: James Cassidy <James@cassidysunblinds.co.uk>
Subject: RE: SO16673 Taylor

Hi James,

~~I think these two could work.~~

Are you able to send us a quote for both options, operated with Somfy Sonesse Ultra 30 RTS Li-Ion battery motors, Perspective 3% (non-silver backed) and a white metal bottom bar (I think the Gemini one would do)?

Sizes are:

- 1770 x 2170mm (blind size)
- 1600 x 2170mm (blind size)
- 1770 x 2170mm (blind size)

Plus 1x 5 channel remote and a charger (with the longest cable possible, no extension). Many thanks.

Kind Regards

Tamara
Lopez-Dominguez

Interior Design Advisor
tamara@cpinteriors.je



Unit 28 Rue Des Pres Trading Estate
St Saviour
Jersey
JE2 7QN
01534 768141 | www.cpinteriors.je
 

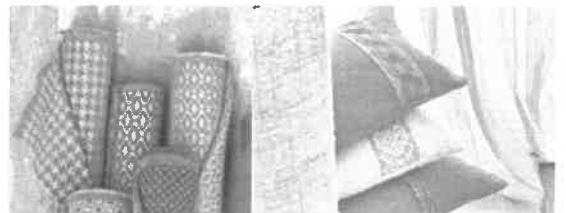

With our CP Price promise. we will beat any
** On like for like products only

From: James Cassidy <James@cassidysunblinds.co.uk>
Sent: 05 November 2025 18:05
To: Tamara Lopez-Dominguez <Tamara@cpinteriors.je>
Subject: RE: SO16673 Taylor

Hi Tamara

Yes we can offer either the flat fascia in 70mm or 100mm in white, black or anthracite.

Alternative we can offer the 75mm or 90mm square fascia in white only.

I have attached said data sheets.

If these are not suitable I maybe able to source an alternative if you can give me a bit more of an idea the style the customer is looking for.

I trust this helps, any questions please give me a call.

Kind regards

James Cassidy

Quote

Q38591-64587



Customer: CP Interiors
Contact Name: Tamara Lopez-Dominguez

Quote Date: 13/11/2025

Customer Ref.: SO16673 Taylor - Fascia

System	Ref. No.	Finish & Width	Finish d Drap	Operation	Fabric Joins	Tube Dia.	Hem Bar	Hem Bar Colour	Hardware Colour	Fabric Type	Fabric	Colour	Type	Shape	Channel/Bracket Type	Bottom Angle	Cust. Ref	Notes	Unit RRP	Unit Price	Qty	Total
Evolve	1	1770	2170	Low Voltage - Sonesse 30 RTS WF 2/20	0	44	Luxur y 35	White	White	Respective 3% - 3m	Respective 3% - 3m	TBC	Fascia 80	Square	No Channels	No	1		£865.46	£380.80	1	£380.80
Evolve	2	1600	2170	Low Voltage - Sonesse 30 RTS WF 2/20	0	44	Luxur y 35	White	White	Respective 3% - 3m	Respective 3% - 3m	TBC	Fascia 80	Square	No Channels	No	2		£949.45	£373.76	1	£373.76
Evolve	3	1770	2170	Low Voltage - Sonesse 30 RTS WF 2/20	0	44	Luxur y 35	White	White	Respective 3% - 3m	Respective 3% - 3m	TBC	Fascia 80	Square	No Channels	No	3		£865.46	£380.80	1	£380.80
																			Blinds total		3	£1,135.38

Special Notes

Your blinds are costed above, please see the last page for additional items

Delivery Address

Spectrum Supply via Umbra, 31 Ystrad Road, Swansea West Business Park, Swansea, SA5 4BT
 Tel: 01792 562015 E-mail: sales@umbra shading.co.uk

The above sizes are blind sizes which will be used for manufacture
 The above pricing excludes VAT

Please note that the above pricing is based on this quotation being ordered in full on a single purchase order. Should you require these blinds in phases please discuss this with us as it may affect the pricing.

- ① £952
- ② £934
- ③ £952

Quote

Q38591-64587



£121.5

Customer: CP Interiors
Contact Name: Tamara Lopez-Dominguez

Order Date: 13/1/2025

Customer Ref.: SO16673 Taylor - Fascia

Total Quantity: 5
Total Price: £1,202.06

Part No.	Details	Length	Unit RRP	Unit Price	Quantity	Total Price
1870420	Siluro 5 RTS Pure II Multichannel Radio Control Handset		£127.65	£40.85	1	£40.85
9021027	Sonessa Wireless Charger - 4m Standard Carriage		£23.74 £18.25	£7.60 £18.25	1 1	£7.60 £18.25
Parts total: £68.70						
Blinds total: £1,133.36						
Grand total: £1,202.06						

Special Notes

Delivery Address

Spectrum Supply Via Umbra, 31 Ystrad Road, Swansea West Business Park, Swansea, SA5 4BT
Tel: 01792 562016 E-mail: sales@umbrashading.co.uk

The above sizes are blind sizes which will be used for manufacture
The above pricing excludes VAT

Please note that the above pricing is based on this quotation being ordered in full on a single purchase order. Should you require these blinds in phases please discuss this with us as it may affect the pricing.

Quote

Q38591-64436



Customer: CP Interiors

Quote Date: 3/11/2025

Customer Ref.: SO16673 Taylor

Contact Name: Tamara Lopez-Dominguez

System	Ref. No.	Finish of Width	Finish of Depth	Operation	Fabric Joins	Tube Dia.	Hem Bar	Hem Bar Colour	Hardware Colour	Fabric Type	Colour	Type	Shape	Channel/Bracket Type	Bottom Angle	Cust. Ref	Notes	Unit RRP	Unit Price	Qty	Total	
Evolve	1	1770	2170	Low Voltage - Sonesse 30 RTS WF 2/20	0	44	Luxur y 35	White	White	Pespective 3% - 3m	TBC	Cassette 80	Square	No Channels	No	1		£1,076.25	£473.55	1	£473.55	
Evolve	2	1600	2170	Low Voltage - Sonesse 30 RTS WF 2/20	0	44	Luxur y 35	White	White	Pespective 3% - 3m	TBC	Cassette 80	Square	No Channels	No	2		£1,049.25	£461.67	1	£461.67	
Evolve	3	1770	2170	Low Voltage - Sonesse 30 RTS WF 2/20	0	44	Luxur y 35	White	White	Pespective 3% - 3m	TBC	Cassette 80	Square	No Channels	No	3		£1,076.25	£473.55	1	£473.55	
																			Blinds total		3	£1,408.77

①
②
③

Special Notes

Delivery Address

Your blinds are costed above, please see the last page for additional items

Spectrum Supply Via Umbra, 31 Ystrad Road, Swansea West Business Park, Swansea, SA5 4BT
Tel: 01792 562015 E-mail: sales@ur-brashading.co.uk

The above sizes are blind sizes which will be used for manufacture
The above pricing excludes VAT

Please note that the above pricing is based on this quotation being ordered in full on a single purchase order. Should you require these blinds in phases please discuss this with us as it may affect the pricing.

① £1,184
② £1,154
③ £1,184

Quote

Q38591-64436



Customer: CP Interiors
Contact Name: Tamara Lopez-Dominguez

Order Date: 3/11/2025

Customer Ref.: SO16673 Taylor

Total Quantity 5
Total Price £1,475.47

Part No.	Details	Unit RRP	Unit Price	Quantity	Total Price
1870420	Siluo 5 RTS Pure II Multichannel Radio Control Handset	£127.65	£40.85	1	£40.85
9021027	Sonessie Wirefree Charger - 4m Standard Carriage	£23.74	£7.60	1	£7.60
		£18.25	£18.25	1	£18.25
Parts total:					£66.70
Blinds total:					£1,408.77
Grand total:					£1,475.47

1102
£19

Special Notes

Delivery Address

Spectrum Supply via Umbra, 31 Ystrad Road, Swansea West Business Park, Swansea, SA5 4BT
 Tel: 01792 562015 E-mail: sales@umbra shading.co.uk

The above sizes are blind sizes which will be used for manufacture
 The above pricing excludes VAT

Please note that the above pricing is based on this quotation being ordered in full on a single purchase order. Should you require these blinds in phases please discuss this with us as it may affect the pricing.

PREMIERCHOICE

MANUFACTURERS OF QUALITY CUSTOM MADE CURTAINS, PELMETS AND BLINDS

CP INTERIORS JERSEY
RUE DES PRES TRADING ESTATE
ST SAVIOUR
JERSEY
JE2 7QN

Re: 10048 / 1 - SO16673 TAYLOR

16 April 2025

Dear Customer,

THIS IS AN ESTIMATE ONLY. SHOULD YOU WISH TO PLACE AN ORDER KINDLY SEND A DETAILED WORKSHEET WHERE POSSIBLE USING THE PREMIER CHOICE ORDER FORM TO orders@premierchoice.co.uk

We thank you for your enquiry and we have the pleasure in estimating you as follows:

VOILES

1 Pair of Voiles Double Pinch Pleat Railroaded

£ 580.83

Rail size of 714cm, Drop of 244cm, Overall rail size: 714cm, 8.4 Mts in each

Making: 16.6 Mts

Fabric: Wide fabric - 300cm wide, no repeat 16.8 mts

Snake weight to hem (Bottom)

£1,452

Others Subtotal: £ 580.83

Total: £ 580.83

Any additional work/material, not mentioned in the above estimate, will be invoiced for. Please note all Velvet fabrics are subject to 10% surcharge as per price list.

THIS IS AN ESTIMATE ONLY.

SHOULD YOU WISH TO PLACE AN ORDER KINDLY SEND A DETAILED WORKSHEET WHERE POSSIBLE USING THE PREMIERCHOICE ORDER FORM.

ALL EMAILED ORDERS PLEASE EMAIL TO ORDERS@PREMIERCHOICE.CO.UK
PLEASE QUOTE ESTIMATE NUMBER SUPPLIED.

Lead Times are subject to availability.

Assuring you of our best attention at all times.

E.& O.E

Yours Faithfully
SallyWaddilove
Premierchoice Ltd

Unit 6 and 7 Five Arches Business Est
off Maidstone Road
Sidcup
Kent
DA14 5AE
Tel: 020 8269 6400 Fax: 020 8269 6401

Vat No: 324 0532 02
Cust Order No: SO16673 TAYLOR
Order Date: 15/04/2025
Order No: 5169305
Cust Ref:
Account Ref: CPS007
Despatch Method: DHL Economy

Order To:
C.P Interiors 2
Rue Des Pres Trading Estate
St Saviour
Jersey
Channel Islands
JE2 7QN

Deliver To:
C.P Interiors 2
Rue Des Pres Trading Estate
St Saviour
Jersey
Channel Islands
JE2 7QN

Type	Colour	Width	Drop	Quantity	Unit Price	Disc %	Net
1. Roller - Sonesse Ultra 30 RTS/Zigbee LI-ION Perspective Aluview FR 3 Grey 2.5m R/F (L)1770 Sonesse Ultra 30 WF RTS 2nm LI ION Motor, Not Required, No Handset Required, Not Required, No Hub Required, 40mm Roller Tube, No Headbox Required, No Brackets Required, Standard P.V.C. Bottom Rail - 5m - White, No Scallop, No Braid Required, No Pole, No Finial, No Eyelets Required, Standard Roll, Blind is safe by design and requires no additional devices or warning labels Measurement: Blind Size Location: Kitchen W1		2170	2170	1	309.34	51.92 110.33	253.70
							£634
2. Roller - Sonesse Ultra 30 RTS/Zigbee LI-ION Perspective Aluview FR 3 Grey 2.5m R/F (L)1600 Sonesse Ultra 30 WF RTS 2nm LI ION Motor, Not Required, No Handset Required, Not Required, No Hub Required, 40mm Roller Tube, No Headbox Required, No Brackets Required, Standard P.V.C. Bottom Rail - 5m - White, No Scallop, No Braid Required, No Pole, No Finial, No Eyelets Required, Standard Roll, Blind is safe by design and requires no additional devices or warning labels Measurement: Blind Size Location: Kitchen W2		2170	2170	1	277.37	51.92 109.17	237.77
							£594
3. Roller - Sonesse Ultra 30 RTS/Zigbee LI-ION Perspective Aluview FR 3 Grey 2.5m R/F (L)1770 Sonesse Ultra 30 WF RTS 2nm LI ION Motor, Not Required, No Handset Required, Not Required, No Hub Required, 40mm Roller Tube, No Headbox Required, No Brackets Required, Standard P.V.C. Bottom Rail - 5m - White, No Scallop, No Braid Required, No Pole, No Finial, No Eyelets Required, Standard Roll, Blind is safe by design and requires no additional devices or warning labels Measurement: Blind Size Location: Kitchen W3		2170	2170	1	309.34	51.92 110.33	253.70
							£634

Net Total: 745.17
VAT: 0.00
Total: 745.17

Charger £20
Situa 5 £90

Q U O T A T I O N

QUOTE TAYLOR

1/0974829

15/04/25

C P Interiors
Rue des Pres Trading Estate
Longueville
St Saviour
Jersey

INCOTERMS DAP

JE2 7QN

TAKEN BY- SALLYB

LINE	PROD	VERS	COLOUR	BRACKET	LOUVRE	STACK	QTY	UNIT	MTRS	TOTALS	DESCRIPTION	PRICE CTG
====	====	====	=====	=====	=====	=====	===	=====		=====	=====	=====

1	6840	A	W				1	7.040			WHITE READY ASSEMBLED HAND OPERATED	A
							@	305.51	EACH	=	305.51	CURTAIN TRACK

GROSS QUOTATION VALUE :- 305.51

-40% x 2.5 = £458

NETT OF DISCOUNTS 152.76

CARRIAGE NETT 30.00

Please excuse computerised print out - this is an instant response budget quotation.



CP INTERIORS

QUOTE

Followed up 23/09/25

Requested quote from Umbran to offer a different type of fascia.

To:
Jo & Peter Taylor
Clos Des Pins
The Avenue
St Clement
JE2 6PD

Job Number: S016673 Q1
Customer Reference:

Quote Date: Thursday 17 Apr 2025
Deposit required: £ 1,035.30
Your Contact: Tamara

Our Price Promise to you
We are so confident our pricing is competitive, that we will beat any written quotation for equivalent product by 5%

To supply and fit unless otherwise stated.

Location	Product	Description	Qty	Price
		OPTION 1 - Battery Operated Roller Blinds		
		Roller blind in Perspective Aluview 3% silver backed mesh fabric, in a colour of your choice. Operated with a Somfy Sonesse Ultra 30 RTS Li-Ion re-chargeable battery motor. <i>Beige (non-silver back)</i>		
Kitchen W1	Roller blind		1	£ 634.00
Kitchen W2	Roller blind		1	£ 594.00
Kitchen W3	Roller blind		1	£ 634.00
	Accessories	Situo 5 remote and charger	1	£ 110.00
	Optional Upgrade	3x Li-Ion magnetic adapters (1x per blind) and 1x Li-Ion magnetic extension (household). £53 to be added to the subtotal.	1	

Terms: 50% deposit due with order, 50% on completion

** To go ahead with this quote please make deposit payment. To pay by card call us on 01534 768141 **

Direct Deposit - Sort Code: 60-12-03 Account: 66577772

If you have any queries please call us on 01534 768141 or visit our showroom Rue des Pres Trading Estate St Saviour

** For Our Terms & Conditions of Sale please go to www.cpinteriors.je **

Subtotal	£ 1,972.00
GST	£ 98.60
Total	£ 2,070.60
Paid amount	£ 0.00
Total amount	£ 2,070.60

Please note: This quotation is only valid for acceptance for 7 days. Our estimate does not include any electrical work or additional carpentry work to install the above unless otherwise specified. Please note there is a handling charge on customer own fabric of £7.50 per metre. Due to high costs of labour, pre-arranged missed fitting appointments will be charged on a time-wasted basis. Settlement is due on completion of works and an administration charge of £25 will be added per month if unpaid within 30 days. We reserve the right to charge for design, advice and liaison work carried out should an order not be placed. Goods remain the property of CP Interiors until full settlement is received. Should payment not be received we reserve the right to attend premises during working hours to remove goods and not be required to make good. Our full terms and conditions apply and are available on request.

Re - quote with fascia similar to fascia in showroom
White metal bottom bar, not covered in fabric.

Extra long charger cable (no extension)



CP INTERIORS

QUOTE

To:
Jo & Peter Taylor
Clos Des Pins
The Avenue
St Clement
JE2 6PD

Job Number: SO16673 Q2
Customer Reference:

Quote Date: Thursday 17 Apr 2025
Deposit required: £ 1,288.35
Your Contact: Tamara

Our Price Promise to you
We are so confident our pricing is competitive, that we will beat any written quotation for equivalent product by 5%

To supply and fit unless otherwise stated.

Location	Product	Description	Qty	Price
		OPTION 2 - Voiles on ceiling mounted track		
Kitchen	Curtain Making	Pair of voiles, with a double pleat header and a lead weight inside a 75mm bottom hem.	1	£ 1,452.00
Kitchen	Fabric	17m of a plain double width fabric of your choice. Price guide based on Warwick Rhodes @£32 per metre.	1	£ 544.00
Kitchen	Curtain Pole / Track	SG6840 in white, with standard gliders and top fix brackets. Hand operation.	1	£ 458.00
	Optional Upgrade	100cm white draw rod @£29 each to be added to the subtotal.	2	
		Subject to final measurements once flooring has been laid		

Terms: 50% deposit due with order, 50% on completion

**** To go ahead with this quote please make deposit payment. To pay by card call us on 01534 768141 ****

Direct Deposit - Sort Code: 60-12-03 Account: 66577772

If you have any queries please call us on 01534 768141 or visit our showroom
Rue des Pres Trading Estate St Saviour

** For Our Terms & Conditions of Sale please go to www.cpinteriors.je **

Subtotal	£ 2,454.00
GST	£ 122.70
Total	£ 2,576.70
Paid amount	£ 0.00
Total amount	£ 2,576.70

Please note: This quotation is only valid for acceptance for 7 days. Our estimate does not include any electrical work or additional carpentry work to install the above unless otherwise specified. Please note there is a handling charge on customer own fabric of £7.50 per metre. Due to high costs of labour, pre-arranged missed fitting appointments will be charged on a time-wasted basis. Settlement is due on completion of works and an administration charge of £25 will be added per month if unpaid within 30 days. We reserve the right to charge for design, advice and liaison work carried out should an order not be placed. Goods remain the property of CP Interiors until full settlement is received. Should payment not be received we reserve the right to attend premises during working hours to remove goods and not be required to make good. Our full terms and conditions apply and are available on request.

Unit 6 and 7 Five Arches Business Est
off Maidstone Road
Sidcup
Kent
DA14 5AE
Tel: 020 8269 6400 Fax: 020 8269 6401

Vat No: 324 0532 02
Cust Order No: SO16673 TAYLOR
Order Date: 12/11/2025
Order No: 5169305
Cust Ref:
Account Ref: CPS007
Despatch Method:DHL Economy

Order To:
C.P Interiors 2
Rue Des Pres Trading Estate
St Saviour
Jersey
Channel Islands
JE2 7QN

Deliver To:
C.P Interiors 2
Rue Des Pres Trading Estate
St Saviour
Jersey
Channel Islands
JE2 7QN

Type	Colour	Width	Drop	Quantity	Unit Price	Disc %	Net
1. Roller - Sonesse Ultra 30 RTS/Zigbee LI-IONPerspective Aluview FR 3 Grey 2.5m R/F (L)1770 Sonesse Ultra 30 WF RTS 2nm LI ION Motor, Not Required, No Handset Required, Not Required, No Hub Required, 40mm Roller Tube, No Headbox Required, No Brackets Required, Gemini B/Bar - White (Shaped Side Front Facing), No Scallop, No Braid Required, No Pole, No Finial, No Eyelets Required, Standard Roll, Blind is safe by design and requires no additional devices or warning labels Measurement: Blind Size Location: Kitchen W1		2170	2170	1	309.34	51.92 137.86	266.93
							<i>£667</i>
2. Roller - Sonesse Ultra 30 RTS/Zigbee LI-IONPerspective Aluview FR 3 Grey 2.5m R/F (L)1600 Sonesse Ultra 30 WF RTS 2nm LI ION Motor, Not Required, No Handset Required, Not Required, No Hub Required, 40mm Roller Tube, No Headbox Required, No Brackets Required, Gemini B/Bar - White (Shaped Side Front Facing), No Scallop, No Braid Required, No Pole, No Finial, No Eyelets Required, Standard Roll, Blind is safe by design and requires no additional devices or warning labels Measurement: Blind Size Location: Kitchen W2		2170	2170	1	277.37	51.92 133.66	249.54
							<i>£624</i>
3. Roller - Sonesse Ultra 30 RTS/Zigbee LI-IONPerspective Aluview FR 3 Grey 2.5m R/F (L)1770 Sonesse Ultra 30 WF RTS 2nm LI ION Motor, Not Required, No Handset Required, Not Required, No Hub Required, 40mm Roller Tube, No Headbox Required, No Brackets Required, Gemini B/Bar - White (Shaped Side Front Facing), No Scallop, No Braid Required, No Pole, No Finial, No Eyelets Required, Standard Roll, Blind is safe by design and requires no additional devices or warning labels Measurement: Blind Size Location: Kitchen W3		2170	2170	1	309.34	51.92 137.86	266.93
							<i>£667</i>
Net Total:							783.40
VAT:							0.00
Total:							783.40

