

Adrian checked in office on 17/12/24



CP INTERIORS

QUOTE

To:
Mr. Ben Thomason
Dell Farm
La Rue Du Bocage
St Brelade
JE3 8BP

Job Number: SO16273Q2
Customer Reference:
Master Bedroom

Quote Date: Tuesday 17 Dec 2024
Deposit required: £ 7,718.76
Your Contact: Tamara

Our Price Promise to you
We are so confident our pricing is competitive, that we will beat any written quotation for equivalent product by 5%

To supply and fit unless otherwise stated.

Location	Product	Description	Qty	Price
Master Bedroom Angled Window	Skylight	SG2195 motorised skylight system with bend in dimout colorama fabric 463, and white hardware. RTS right-hand side hardwired motor.	1	£ 7,192.00
Master Bedroom Sloped Window	Skylight	SG2195 motorised skylight system in dimout colorama fabric 463, and white hardware. RTS right-hand side hardwired motor.	1	£ 6,044.00
	Accessories	5 channel remote to operated both SG2195,	1	£ 281.00
Master bedroom skylights	Optional Upgrade	Custom-coloured hardware in one of the RAL standard colours available. Client to provide RAL colour number, Electrical works not included,	1	£ 720.00
Gable End	Curtain Making	Hand finished pair of curtains, with a single pleat header and blackout lining. This pair of curtains will cover the 3 windows on that end.	1	£ 998.00
	Curtain Pole / Track	Artisan 16mm Stopper pole in Black Wrought Iron. Includes face fix brackets and rings. ✓	1	£ 354.00
Dormer Window	Curtain Making	Hand finished single curtain, with a single pleat header and blackout lining.	1	£ 634.00
	Curtain Pole / Track	✓ Hand drawn track in white with standard gliders and a bend. ✓ To be fitted inside Blindspace recess profile.	1	£ 456.00
Master Bedroom Low Window	Roman blind	✓ with a pelmet flap and bonded blackout lining. Manually operated with a side silver chain (control side TBC).	1	£ 427.00
	Fabric for curtains and Roman blind	26.5m of a plain single width fabric of your choice. Price guide based on Romo Linara @£48 per metre., Subject to final measurements,	1	£ 1,272.00

ordered 18/12/24 as instructed by Adrian

✓ 2.7m ordered for Roman

Terms: 40% deposit due with order, 40% on delivery & final 20% on completion

**** To go ahead with this quote please make deposit payment. To pay by card call us on 01534 768141 ****

Direct Deposit - Sort Code: 60-12-03 Account: 66577772

If you have any queries please call us on 01534 768141 or visit our showroom Rue des Pres Trading Estate St Saviour

**** For Our Terms & Conditions of Sale please go to www.cpinteriors.je ****

Subtotal	£ 18,378.00
GST	£ 918.90
<hr/>	
Total	£ 19,296.90
Paid amount	£ 0.00
Total amount	£ 19,296.90

Please note: This quotation is only valid for acceptance for 7 days. Our estimate does not include any electrical work or additional carpentry work to install the above unless otherwise specified. Please note there is a handling charge on customer own fabric of £7.50 per metre. Due to high costs of labour, pre-arranged missed fitting appointments will be charged on a time-wasted basis. Settlement is due on completion of works and an administration charge of £25 will be added per month if unpaid within 30 days. We reserve the right to charge for design, advice and liaison work carried out should an order not be placed. Goods remain the property of CP Interiors until full settlement is received. Should payment not be received we reserve the right to attend premises during working hours to remove goods and not be required to make good. Our full terms and conditions apply and are available on request.



Farnborough Blind Company Ltd

Unit 7 North Downs Business Park, Limepit Lane, Sevenoaks Kent, TN13 2TL

TEL: 01732 456304 FAX: 01732 453653 EMAIL: sales@farnboroughblinds.com

TRADE ESTIMATE

DATE	16 December 2024	TO	Leeana Taft
FROM	Bill Wyatt	COMPANY	CP INTERIORS
OUR REF	71459	YOUR REF	SO16395 Thomason
TOTAL NO OF PAGES			2

Dear Leeana Taft

We thank you for your enquiry and have pleasure in submitting our estimate as follows: -

To supply only

TYPE	BlindSpace Boxes
------	------------------



Location	Qty	Width	ITEM	Notes	PRICE EACH	TOTAL EX VAT
1)	1.00	1400	Track Trim Recess track with plaster flanges 6m Lengths -		£65.20	£65.20
2)	1.00	440	Track Trim Recess track with plaster flanges 6m Lengths -		£46.57	£46.57
3)	1.00		90 Degree Corner 290 Rad (4 x 22.5 degree) Reese -		£123.13	£123.13
4)	2.00		Flat Endcap - FE35F -		£8.86	£17.72
5)	2.00		Splice Pins Pack of 4 -		£16.08	£32.16
Option 1	1.00	1800	HAND DRAWN TRACK ST RUNNERS - FBC Equivalent to SG 6970		£93.96	£93.96
	1.00		290 radius Bend		£65.00	£65.00
Option 2	1.00		Silent Gliss 6970 @ 1800mm including 1 x bend		£492.45	£492.45

22x runners

£394 + £62

£1231

C2825

1 + 2 + 3 + CUT CHARGES (PTO) £286.89 x 2.5 =

4) x 2.5 = £44

5) x 2.5 =

SO16273Q2 THOMASOJ

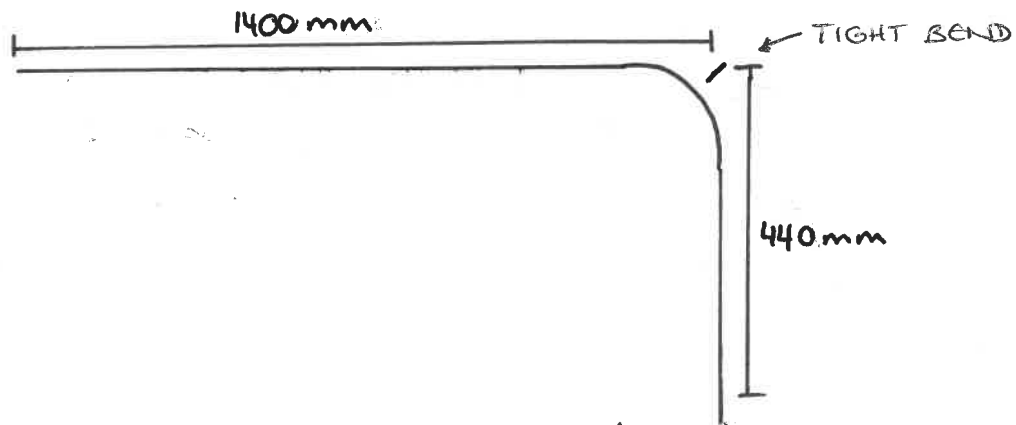

- SGG970 in white, standard gliders to be fitted inside a Reese profile. / OR EQUIVALENT
- MANUAL OPERATION

Tropical Blinds Ltd

Quotation
Customer Copy

Unit 6 and 7 Five Arches Business Est
off Maidstone Road
Sidcup
Kent
DA14 5AE
Tel: 020 8269 6400 Fax: 020 8269 6401

ORDERED

Vat No: 324 0532 02
Cust Order No: SO16273Q2 THOMASON
Order Date: 20/02/2025
Order No: 4889039
Cust Ref:
Account Ref: CPS007
Despatch Method: DHL Economy

Order To:
C.P Interiors
Rue Des Pres Trading Estate
St Saviour
Jersey
Channel Islands
JE2 7QN

Deliver To:
C.P Interiors
Rue Des Pres Trading Estate
St Saviour
Jersey
Channel Islands
JE2 7QN

Type	Colour	Width	Drop	Quantity	Unit Price	Disc %	Net
1. Cust Own Roman	Customer's Own Fabric	1550	800	1	139.11	10	160.89
Waterfall (Standard), Lining - Bonded BLACKOUT (with Fleece 400g EB), Pelmet Required, Evans Right Hand Control (Breakaway), Continuous Metal Chain Chrome, N/A, None Required, No Handset Required, No Power Supply Required, Not Required, Not Required, No Hub Required, Roman Breakaway Chain Mechanism, Not Applicable						39.66	
Measurement: Blind Size		Spec. ins: 2.7m of Romo Linara Almond 2494/541		Chain Length: 500			
Location: Main Bedroom Low window		Fitting ins:					

+ Face fix brackets.

Net Total: 160.89
VAT: 0.00
Total: 160.89

RIB ✓

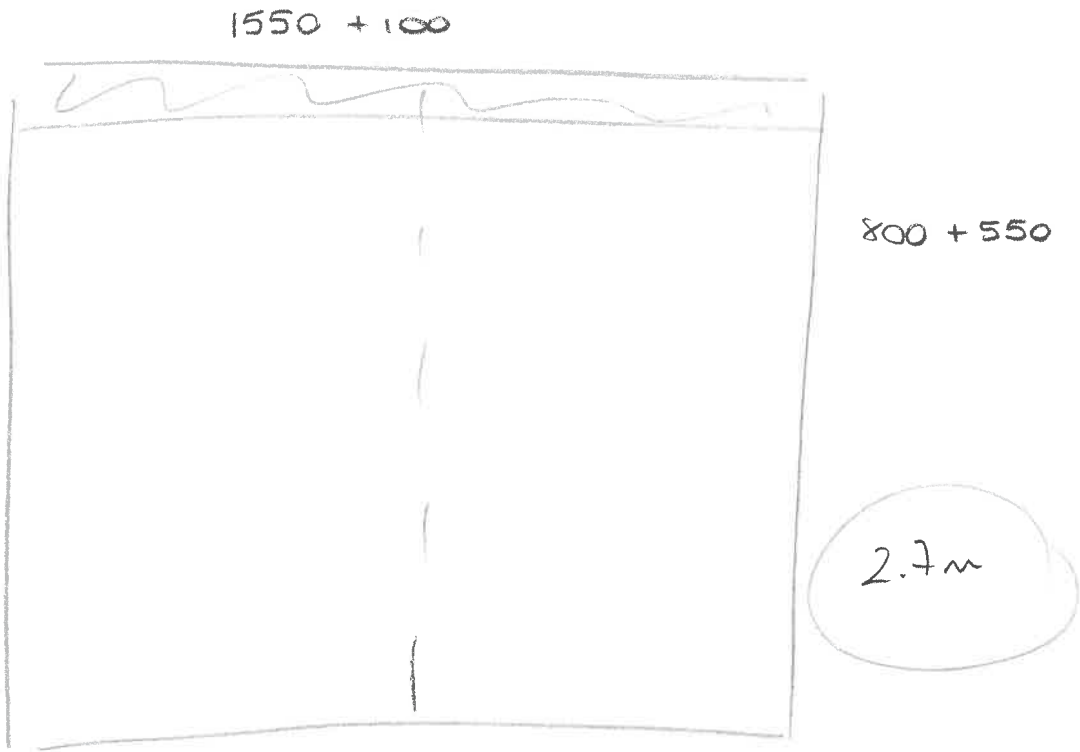

THE ROMO GROUP

Romo Ltd.
Oddicroft Lane
Sutton-in-Ashfield
Nottingham NG17 5FB

EORI No. GB116619866000
VAT Reg No. 116619866
Tel No. 00 44 1623 727016

ORDER CONFIRMATION

Invoice Address

CARPET PROTECTION (CI) LIMITED
T/A CP INTERIORS
RUE DES PRES TRADING ESTATE
ST SAVIOUR
JERSEY
JE2 7QN

Delivery Address

TROPICAL BLINDS
UNITS 6-7 FIVE ARCHES BUSINESS EST
OFF MAIDSTONE ROAD
SIDCUP KENT
DA14 5AQ

PAGE 1

Account	Invoice Date	Order.No.	Carrier	Parcels	Your Order No.	Currency
57744	21/02/25	EX340879	UPS UK Standard		SO16272Q2 THOMASON	STERLING

Quantity	Description	Price	%	Value
2.7	<p>METRES RF 2494/541 LINARA ALMOND Commodity Code: 5212231090 63% Cotton 37% Linen PCE 5212738 Before washing we recommend the cover is turned inside out.</p> <p>We note these goods are being sent to an address that differs from the accounting address. It is particularly important you check visually that the goods physically correspond with the sample from which the order was placed. i.e. correct design, colour, shade etc.</p> <p>All supplies are made subject to the Romo Terms and Conditions of Sale (as amended), copies of which are available on request in our Trade Price List or on the trade section of our website at www.romo.com.</p>	24.00		64.80

THIS IS AN ORDER CONFIRMATION
PLEASE DO NOT PAY. A VAT INVOICE WILL FOLLOW.

VAT Summary		
Code	Goods	VAT
S 20.00%		12.96

Goods	64.80
VAT	12.96
Total	77.76

CURTAIN ORDER FORM WEBSITE

COMPANY CP Interiors	CUSTOMER: Thomason	ORDER REFERENCE: S016273Q2	CONTACT NAME: Tamara
--------------------------------	------------------------------	--------------------------------------	--------------------------------

FABRIC DETAILS: Romo Linara Almond 2494/541	FABRIC WIDTH: 140cm	FABRIC REPEAT: N/A	QUANTITY: 20m	RAILROAD:
---	-------------------------------	------------------------------	-------------------------	------------------

COLOUR OF LINING IVORY OR ALMOND				
---	--	--	--	--

DATE : 02/05/25	PC PREMIUM LINING:	PC STANDARD LINING:	PC BLACKOUT LINING: YES	PC INTERLINING:	PC SATIN FLEECE LINING:
---------------------------	---------------------------	----------------------------	-----------------------------------	------------------------	--------------------------------

TRIM/BRAID /BORDER :	BORDER SIZE:	TOP:	BOTTOM:	LEADING EDGE: Chain stitch	RTN EDGE: Chain stitch
-----------------------------	---------------------	-------------	----------------	--------------------------------------	----------------------------------

ALL MEASUREMENTS MUST BE IN METRIC	PAIR 1	PAIR 2	PAIR 3
PAIR	Master Bedroom Pair		
SINGLE		Master Bedroom Single RHS	
WIDTHS PER CURTAIN			
OVERALL DROP	2387mm 	1590mm	
HOOK HEIGHT EYE DROP			
TRACK SIZE	3000mm	1800mm	
OVERLAPS & RETURNS			

ADDITIONAL INFORMATION:
20m of Linara Almond 2494/541 for all. Single pleat and blackout lining. For the pair, we have a maximum of 34x rings (not all have to be used if not required)

INTERLINED - HANDSEWN			
LINED - HANDSEWN	YES	YES	
LINED - MACHINE			
HEADING PENCIL			
HEADING TRIPLE PINCH			
HEADING DOUBLE PINCH			
DEPTH OF BUCKRAM:			
SINGLE PLEAT & CARTRIDGE PLEAT(CIRCUMFERENCE OF PLEAT IN CM)			
CARTRIDGE FILLED OR UNFILLED			
HEADING WAVE			
INVISIBLE WAVE			
THIS ORDER INCLUDES ON A SEPARATE SHEET (PLEASE TICK APPROPRIATE BOX)			

* Ben Thomason requested 20mm trouser crease
(Please refer to my email to him if needed)

THE ROMO GROUP

Romo Ltd.
Oddicroft Lane
Sutton-in-Ashfield
Nottingham NG17 5FB

EORI No. GB116619866000
VAT Reg No. 116619866
Tel No. 00 44 1623 727016

SALES INVOICE

Invoice Address

CARPET PROTECTION (CI) LIMITED
T/A CP INTERIORS
RUE DES PRES TRADING ESTATE
ST SAVIOUR
JERSEY
JE2 7QN

Delivery Address

PREMIER CHOICE
3-5 ALGORES WAY

WISBECH
CAMBS
PE13 2TQ

Invoice No. **XP330027**

PAGE **1**

Account	Invoice Date	Order No.	Carrier	Parcels	Your Order No.	Currency
57744	06/05/25	EX369053	UPS UK Standard	1	THOMASON SO16273Q2	STERLING

Quantity	Description	Price	%	Value
20.0	METRES RF 2494/541 LINARA ALMOND Commodity Code: 5212231090 C/O : IT 63% Cotton 37% Linen Width (cm) : 140	24.75		495.00
<p>Declaration :-</p> <p>The exporter of the products covered by this document (EORI GB116619866000) declares that, except where otherwise clearly stated, these products are of UK preferential origin.</p> <p>Date & Place of Issue :- 06/05/25 SUTTON-IN-ASHFIELD</p> <p>Signature :-</p> <p>Delivery Terms :- Ex Works</p>				

Settlement Discount Summary

5.00 % Romo Fabrics Rebate 24.75

Please Remit To:-

HSBC Bank PLC
Sort Code: 401118
Account Number: 53680509

Goods 495.00

VAT (S 20.00%) 99.00

Total 594.00

Due If Paid By 30/06/25

Goods 495.00

Settlement -24.75

VAT (S 20.00%) 94.05

Amount Due 564.30

PLEASE INDICATE INVOICE NUMBER BEING PAID

If payment is received after the due date, no rebate or discount is available.

NO credit note will be issued after payment. You must ensure you have only recovered the VAT actually paid.

These goods are sold subject to our standard terms and conditions of sale (as amended), copies of which are available on request in our Trade Price List or on the trade section of our website at www.romo.com.

PREMIERCHOICE

MANUFACTURERS OF QUALITY CUSTOM MADE CURTAINS, PELMETS AND BLINDS

CP INTERIORS JERSEY
RUE DES PRES TRADING ESTATE
ST SAVIOUR
JERSEY
JE2 7QN

Re: 10214 / 1 - SO16273Q2 THOMASON

02 May 2025

Dear Customer,

THIS IS AN ESTIMATE ONLY. SHOULD YOU WISH TO PLACE AN ORDER KINDLY SEND A DETAILED WORKSHEET WHERE POSSIBLE USING THE PREMIER CHOICE ORDER FORM TO orders@premierchoice.co.uk

We thank you for your enquiry and we have the pleasure in estimating you as follows:

PAIR

1 Pair of Curtains Single Pinch Pleat, Hand Finished Lined £ 379.94

Rail size of 300cm, Drop of 238.7cm, Overall rail size: 300cm, 2.5 Widths in each

Making:	6	Widths
Fabric: 00cm pattern repeat	13.5	mts
Lining: Blackout Lining	13.5	mts

7.0 MTRS OF FABRIC BASED ON 300CM WIDE RAILROADED WITH NO PATTERN REPEAT

SINGLE

1 Curtain Single Pinch Pleat, Hand Finished Lined £ 185.42

Rail size of 180cm, Drop of 159cm, Overall rail size: 180cm, 3 Widths in each

Making:	3	Widths
Fabric: 00cm pattern repeat	5.7	mts
Lining: Blackout Lining	5.7	mts

4.2 MTRS OF FABRIC BASED ON 300CM WIDE RAILROADED WITH NO PATTERN REPEAT

Others Subtotal:	£	565.36
-------------------------	----------	---------------

Total:	£	565.36
---------------	----------	---------------

19.5 m ORDER 20m

Any additional work/material, not mentioned in the above estimate, will be invoiced for. Please note all Velvet fabrics are subject to 10% surcharge as per price list.

THIS IS AN ESTIMATE ONLY.

SHOULD YOU WISH TO PLACE AN ORDER KINDLY SEND A DETAILED WORKSHEET WHERE POSSIBLE USING THE PREMIERCHOICE ORDER FORM.

ALL EMAILED ORDERS PLEASE EMAIL TO ORDERS@PREMIERCHOICE.CO.UK
PLEASE QUOTE ESTIMATE NUMBER SUPPLIED.

Lead Times are subject to availability.

Assuring you of our best attention at all times.

E. & O.E

Yours Faithfully
SallyWaddilove
Premierchoice Ltd

Tropical Blinds Ltd

Quotation
Customer Copy

Unit 6 and 7 Five Arches Business Est
off Maidstone Road
Sidcup
Kent
DA14 5AE
Tel: 020 8269 6400 Fax: 020 8269 6401

Vat No: 324 0532 02
Cust Order No: SO16273Q2 THOMASON
Order Date: 10/12/2024
Order No: 4889039
Cust Ref:
Account Ref: CPS007
Despatch Method: DHL Economy

Order To:
C.P Interiors
Rue Des Pres Trading Estate
St Saviour
Jersey
Channel Islands
JE2 7QN

Deliver To:
C.P Interiors
Rue Des Pres Trading Estate
St Saviour
Jersey
Channel Islands
JE2 7QN

Type	Colour	Width	Drop	Quantity	Unit Price	Disc %	Net
1. Cust Own Roman	Customer's Own Fabric	1545	715	1	135.06	10	165.86
Waterfall (Standard), Lining - Bonded BLACKOUT (with Fleece 400g EB), Pelmet Required, Evans Right Hand Control (Breakaway), Continuous Metal Chain Chrome, N/A, None Required, No Handset Required, No Power Supply Required, Not Required, Not Required, No Hub Required, Roman Breakaway Chain Mechanism, Not Applicable							48.16
Measurement: Blind Size Spec. ins:				Chain Length: 400			
Location: Main Bedroom Low window Fitting ins:							

Net Total: 165.86
VAT: 0.00
Total: 165.86

$+ 3\% \times 2.5 = £427$

ARTISAN 16mm Stopper Pole Set 300cm (Black)

2x 150cm poles + joiner

30 rings

Face fix only (3 brackets)

$£141.59 \times 2.5 = £353.98$

~~+ 1x pack of 4 £15.18~~

TOTAL £309

$$1545 + 100$$

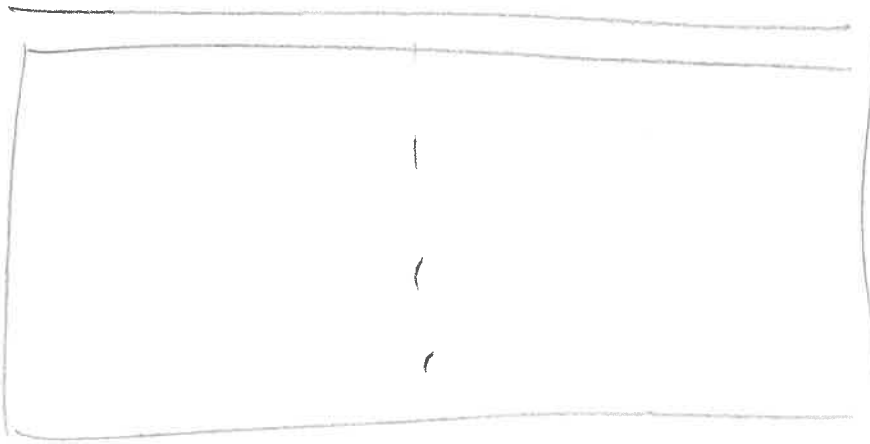

$$715 + 550$$

2.5m

$$1550 + 100$$

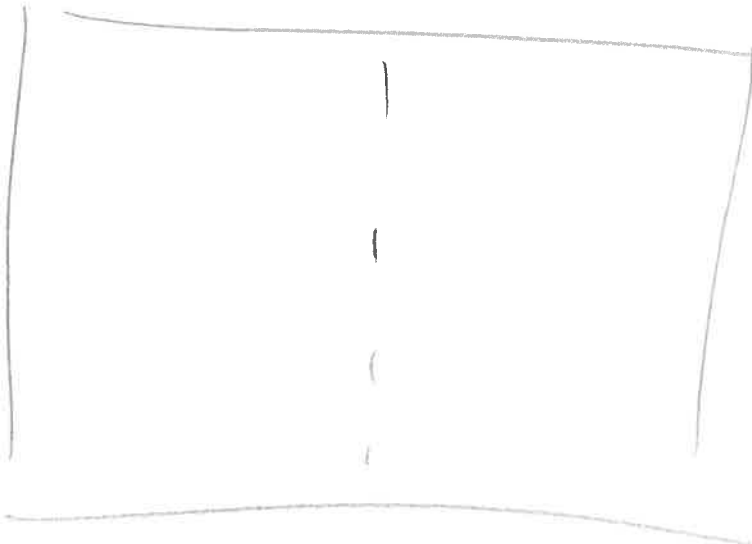

$$800 + 550$$

2.7m

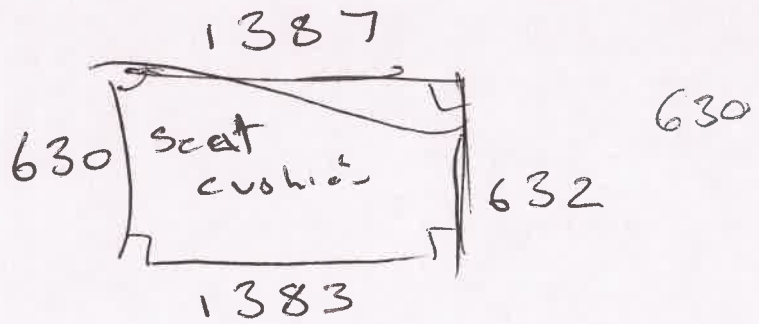

Staff Name Adrian

Work Diary

Order No SO16273Q2 Measurer or Fitter Measurer Contact Address Mr Ben Thomason, Dell Farm, La Rue Du Bocage, St Brelade, JE3 8BP, 07829838787, ben.thomason@colliers.com Customer Ref Master Bedroom Date 17-02-2025 Time 09:30

Notes : To take final measurements. Arranged access with Nathan. If needed ring 07797 913125

Location	Supplier	Blind Type /Description	Colour	Qty	Width	Drop	Fitting Height	Blind/Recess	Controls	Brackets	Surface	Unit Price
Bed		Slaylight (1)		1		See over						
"		" (2)		1		See over						
"		Roman		1	1550	800		1515	off	floor		
-		Curtain pair		1	2900	2367	Drop once				Floor to floor	
					Pole		pole-filled					
					width							
		Bent Curve		1	1800	1620						
		Recess profile & match on site					Clings to sill				→ Adrian told me to deduct 5mm for gap + 25mm for cushion	

Comments:

Order Date

Customer Signature
X
I have checked and agree with the above choices

Target Fitting Date

Client will email to confirm if the curtains will be on the floor or not

trouser crease
If ~~padding~~, add 10mm to above drop (as it is, it's just touching the floor), or deduct 10mm if client wants it off the floor.

Confirmed by Ben on 30/04/25

Ben Thomason has requested a 20mm trouser crease as

12.5ft hand
Mdr

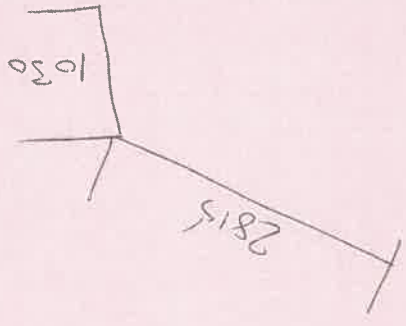

780 L x

②

1090 x 2205
als LHMdr

①

Order Confirmation



Silent Gliss Limited
 Pyramid Business Park, Poorhole Lane
 Broadstairs, Kent, CT10 2PT, England
 01843 863571.
 info@silentgliss.co.uk
 www.silentgliss.co.uk



Changed to flat finish as per Ben Thowson's email on 09/03/25

Silent Gliss Order No: 0971796/1
Customer Reference: SO16563
Account No: 0028823
Order Date: 06/03/2025
Anticipated Despatch Date: TBC
Carrier Shipping Goods: COLLECT
Carrier Service: COLLECTED
Internal Contact: Sally Brown

Invoice address:
 C P Interiors
 Rue des Pres Trading Estate
 Longueville
 St Saviour, Jersey
 EORI: GB013519254000
 JE2 7QN

Delivery address:
 C P Interiors
 Rue des Pres Trading Estate
 Longueville
 St Saviour
 Jersey INCOTERMS DAP
 JE2 7QN

Order Details	Qty	Net Value (GBP)
Order Comments		
TO BE SPRAYED TO RAL 8022 **BEND AS PER PLOT - TRACK 1**		
<hr/>		
2195C F W Width : .780M Drop : 3.826M WHITE ELECTRICALLY OPERATED WINTERGARDEN CANTILEVER WITH FABRIC * with COLORAMA DIMOUT 463 320CM (SOFT) Motor : 2160 1 MOTOR FOR 2150/2180/2195 (220V/50HZ) TRACK 1 **BEND AS PER PLOT** **TO BE SPRAYED TO RAL 8022** Value in GBP	1.00	5,467.00
Discount @ 55.000% & .000%	1.00	3,006.85-
Net in GBP 2460.15		
<hr/>		
9945 RECEIVER LATCHING 868MHZ **ONLY STORES TO PICK** FOR USE WITH ABOVE SKYLIGHT Value in GBP	1.00	345.14
Discount @ 55.000% & .000%	1.00	189.83-
Net in GBP 155.31		
<hr/>		
2190BD 1 2190 BENDING CHARGE. RADIUS 25-99CM Value in GBP	1.00	348.50
Discount @ 25.000% & .000%	1.00	87.13-
Net in GBP 261.37		
<hr/>		
2195C F W Width : 1.090M Drop : 2.205M WHITE ELECTRICALLY OPERATED WINTERGARDEN CANTILEVER WITH FABRIC * with COLORAMA DIMOUT 463 320CM (SOFT) Motor : 2160 1 MOTOR FOR 2150/2180/2195 (220V/50HZ) TRACK 2 **TO BE SPRAYED TO RAL 8022** Value in GBP	1.00	5,026.94
Discount @ 55.000% & .000%	1.00	2,764.82-
Net in GBP 2262.12		

Order Confirmation



Silent Gliss Limited
 Pyramid Business Park, Poorhole Lane
 Broadstairs, Kent, CT10 2PT, England
 01843 863571.
 info@silentgliss.co.uk
 www.silentgliss.co.uk



Silent Gliss Order No: 0971796/1
Customer Reference: SO16563
Account No: 0028823
Order Date: 06/03/2025
Anticipated Despatch Date: TBC
Carrier Shipping Goods: COLLECT
Carrier Service: COLLECTED
Internal Contact: Sally Brown

Invoice address:
 C P Interiors
 Rue des Pres Trading Estate
 Longueville
 St Saviour, Jersey
 EORI: GB013519254000
 JE2 7QN

Delivery address:
 C P Interiors
 Rue des Pres Trading Estate
 Longueville
 St Saviour
 Jersey INCOTERMS DAP
 JE2 7QN

Order Details	Qty	Net Value (GBP)
9945 RECEIVER LATCHING 868MHZ **ONLY STORES TO PICK** FOR USE ON TRACK 2 Value in GBP Discount @ 55.000% & .000% Net in GBP 155.31	1.00 1.00	345.14 189.83-
10302 W 5+1 CHANNEL REMOTE WHITE 868 MHZ *** ONLY STORES TO PICK *** Value in GBP Discount @ 55.000% & .000% Net in GBP 126.28	1.00 1.00	280.63 154.35-
SETUP SETUP CHARGE SET UP FOR SPRAYING ABOVE UNITS TO RAL 8022 Value in GBP Net in GBP 311.50	1.00	311.50
SPRAY SA SPRAYING CHARGE SATIN FINISH SPRAYING CHARGE FOR 2195'S TO BE SPRAYED TO RAL 8022 Value in GBP Net in GBP 276.68	1.00	276.68
Total (Ex. VAT):		£6,008.72

RB

* Check bent measurements

Date of Order: 04/03/2025 Order Reference: SO16563 Date Required: As soon as possible

Company Name: CP Interiors Contact: Tamara Telephone Number: 1534768141

Delivery Address: 28 Rue des Pres Trading Estate, St Saviour Jersey, JE2 7QN

Site Contact: Scott Telephone Number: Customer Signature: _____

System	Qty	*Fitting Application A/B/C see below	Actual Width	Actual Drop	Profile Colour	Fabric Colour & Description	System B = bent, S = Slope, H = Horizontal (as per drawing)	Input LH or RH LH or RH Operation	Crank Drop	Flap Size	Please tick	
											Detachable crank	Fixed crank
SG2195	1	B	780	3845	RAL 8022	DIMOUT COLORENA 463	(as per drawing)	RH MOTOR	N/A			
SG2195	1	B	1090	2205	RAL 8022	DIMOUT COLORENA 463	S	LH MOTOR	N/A			

A. Fitting application inside recess USING 3825

B. Fitting application outside recess USING 3065A 'L' BRACKET

C. Fitting application multiple systems outside recess USING 3066B 'T' BRACKET

D. Please tick application

<input type="checkbox"/>	Headbox fitting possible
<input checked="" type="checkbox"/>	Headbox fitting possible
<input type="checkbox"/>	Headbox fitting possible
<input type="checkbox"/>	Headbox fitting possible

Specify size of flap X =

3803 2116 3803 2116 3803 2116 3803 2116

Sketch / Comments
Flap Sizes:
STD 90mm = 2195
STD 60mm = 2190

Note: For 2190 systems only – If cut-out in fabric flap is required to clear the control handle, please provide exact position dimensions. (may not be possible with all fabrics)

* If fitting does not match above applications please provide a sketch

Note:

- Motor position is when viewed facing the front of the blind.
- If system width and drop are entered this is the size the blind will be made
- If you take the size of a recess we suggest you deduct 5mm from drop only.

SATIN confirmed by Adrian in office on 08/03/25
Changed to Blatte Park as per Ben Thomason's email on 07/09

① 1090 x 2205 8/8 UH Modor

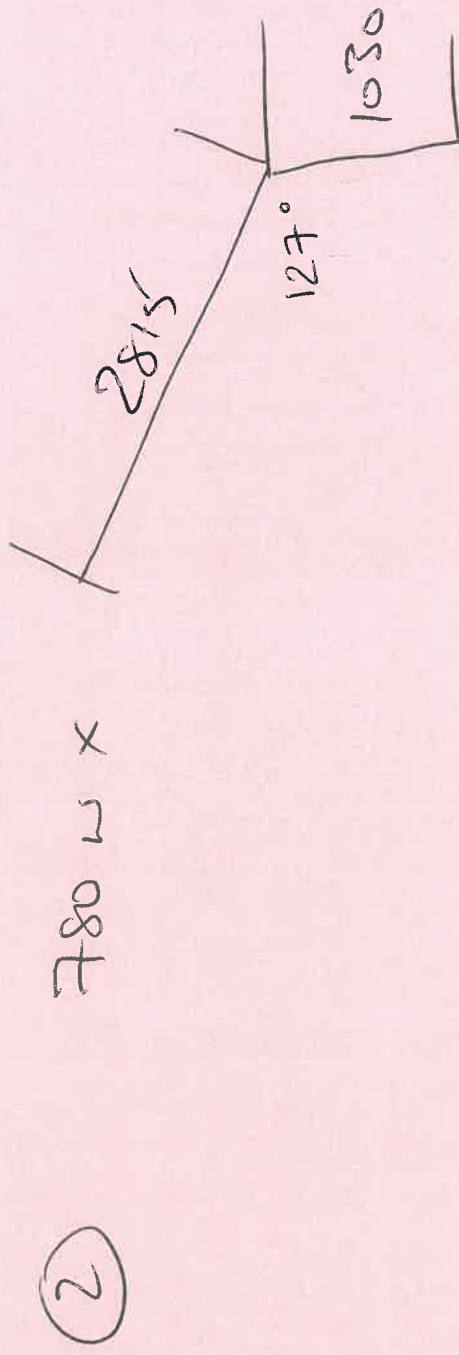

PREMIERCHOICE

MANUFACTURERS OF QUALITY CUSTOM MADE CURTAINS, PELMETS AND BLINDS

CP INTERIORS JERSEY
RUE DES PRES TRADING ESTATE
ST SAVIOUR
JERSEY
JE2 7QN

PLUS 7%
ADDED BY ME

Re: 8659 / 1 - SO16273Q2 THOMASON

17 December 2024

Dear Customer,

THIS IS AN ESTIMATE ONLY. SHOULD YOU WISH TO PLACE AN ORDER KINDLY SEND A DETAILED WORKSHEET WHERE POSSIBLE USING THE PREMIER CHOICE ORDER FORM TO orders@premierchoice.co.uk

We thank you for your enquiry and we have the pleasure in estimating you as follows:

PAIR

1 Pair of Curtains Single Pinch Pleat, Hand Finished Lined	£	372.96
Rail size of 310cm, Drop of 235cm, Overall rail size: 310cm, 3 Widths in each		
Making:	6	Widths
Fabric: 00cm pattern repeat	15.9	mts
Lining: Blackout Lining	15.9	mts

£998

7.2 MTRS OF FABRIC BASED ON 300CM WIDE RAILROADED WITH NO PATTERN REPEAT

SINGLE

1 Curtain Single Pinch Pleat, Hand Finished Lined	£	236.88
Rail size of 184cm, Drop of 165cm, Overall rail size: 184cm, 3.5 Widths in each		
Making:	4	Widths
Fabric: 00cm pattern repeat	7.8	mts
Lining: Blackout Lining	7.8	mts

£634

4.5 MTRS OF FABRIC BASED ON 300CM WIDE RAILROADED WITH NO PATTERN REPEAT

Others Subtotal:	£	609.84
Total:	£	609.84

Any additional work/material, not mentioned in the above estimate, will be invoiced for. Please note all Velvet fabrics are subject to 10% surcharge as per price list.

THIS IS AN ESTIMATE ONLY.

SHOULD YOU WISH TO PLACE AN ORDER KINDLY SEND A DETAILED WORKSHEET WHERE POSSIBLE USING THE PREMIERCHOICE ORDER FORM.

ALL EMAILED ORDERS PLEASE EMAIL TO ORDERS@PREMIERCHOICE.CO.UK
PLEASE QUOTE ESTIMATE NUMBER SUPPLIED.

Lead Times are subject to availability.

Assuring you of our best attention at all times.

E. & O.E

Yours Faithfully
SallyWaddilove
Premierchoice Ltd

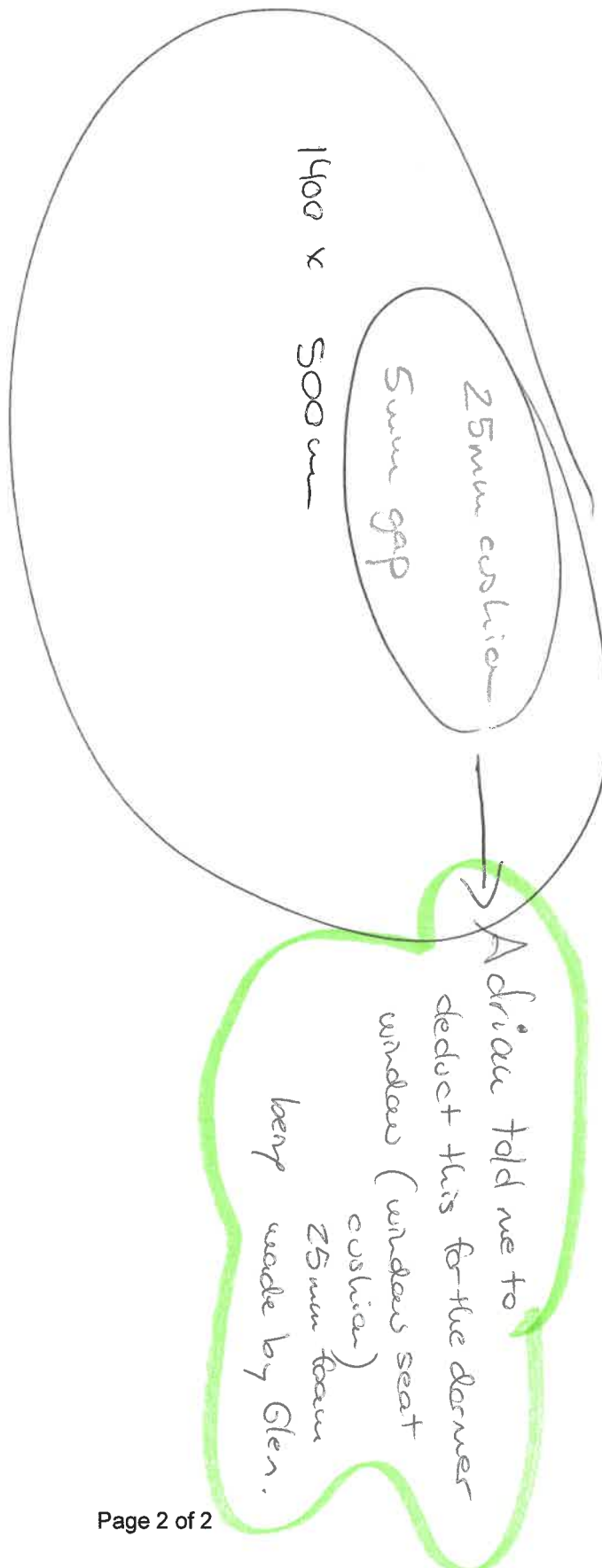

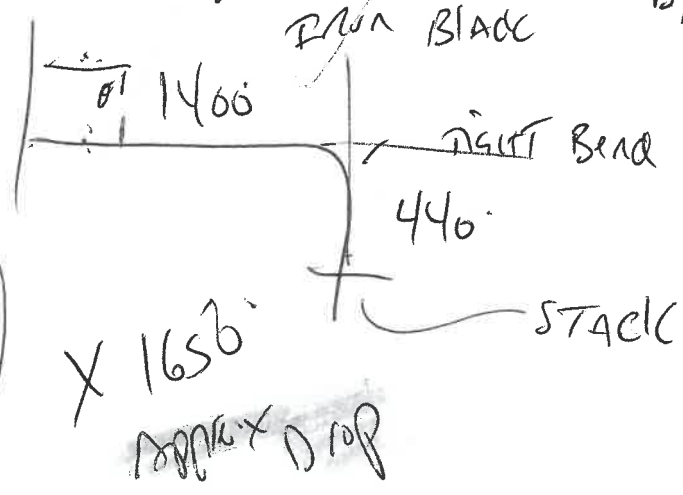
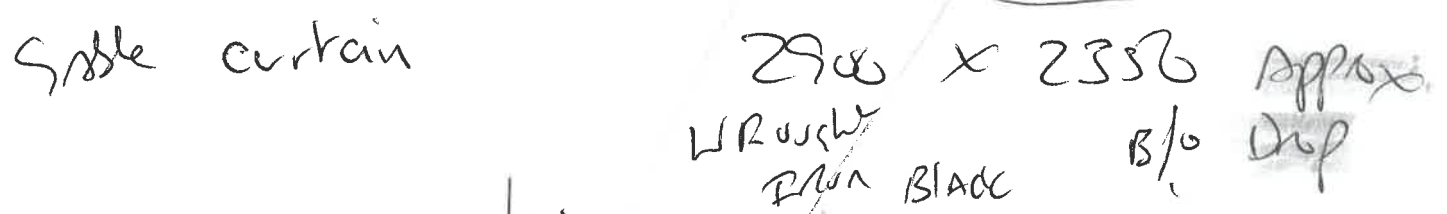
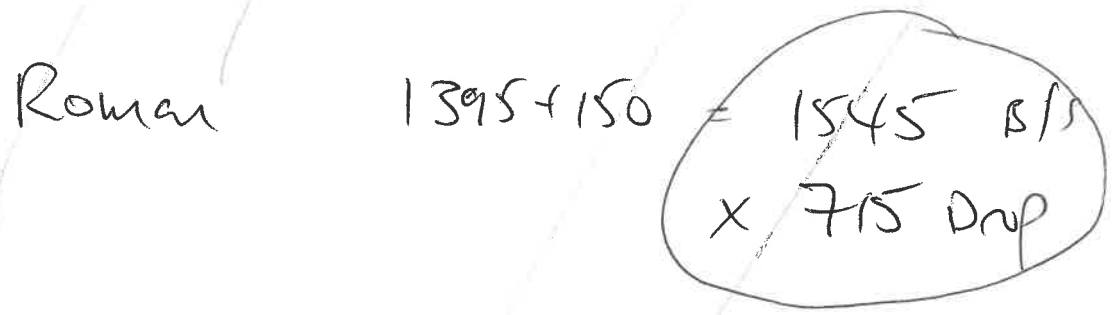
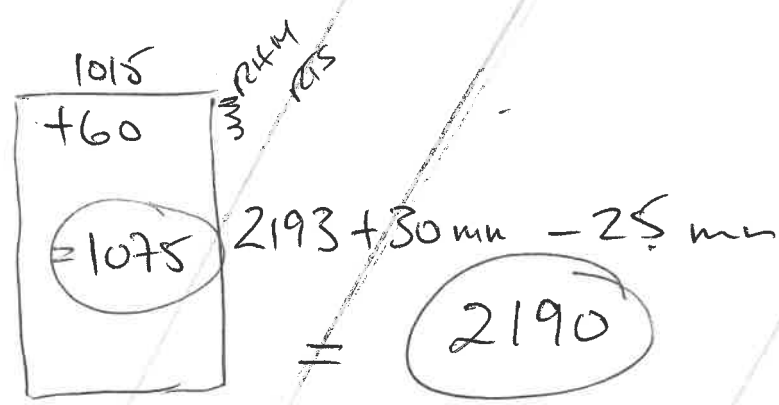
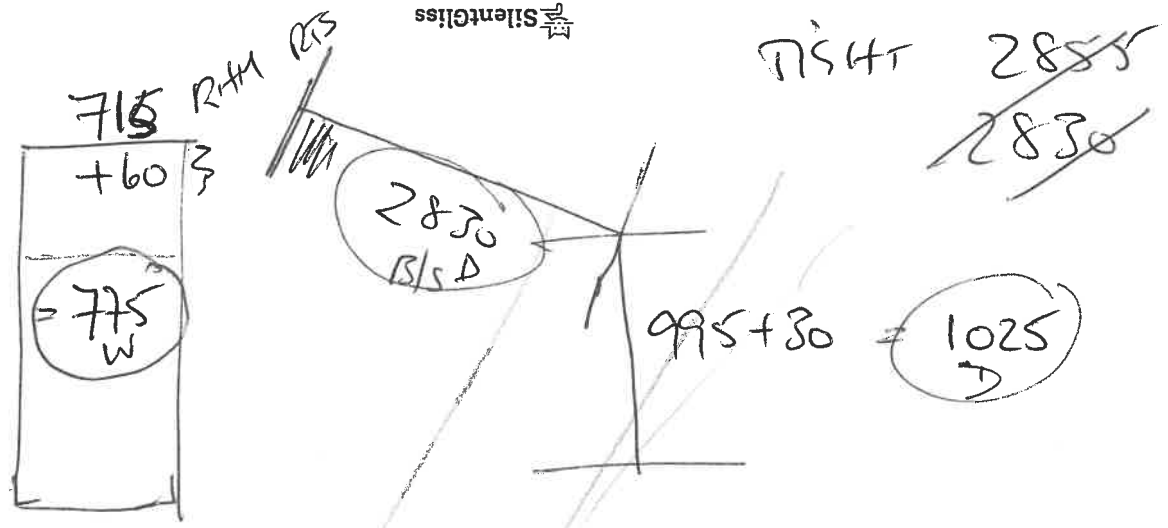

Approx Drop

SO16273Q2 THOMASON

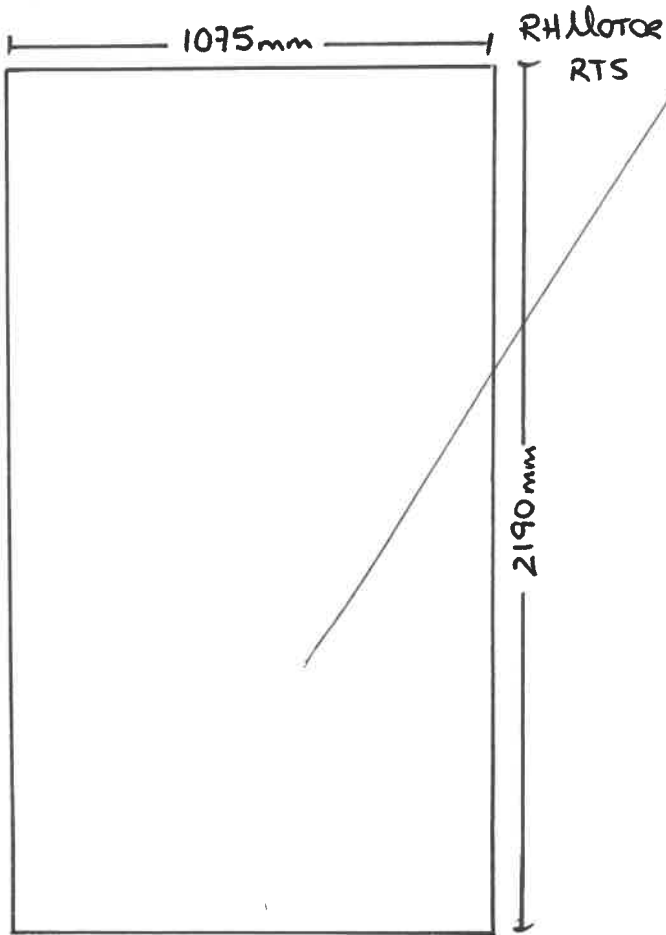
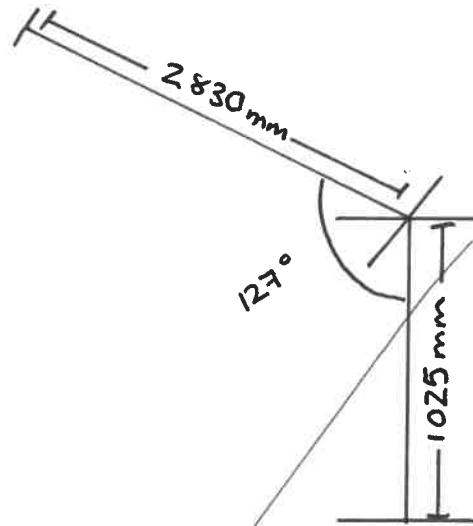
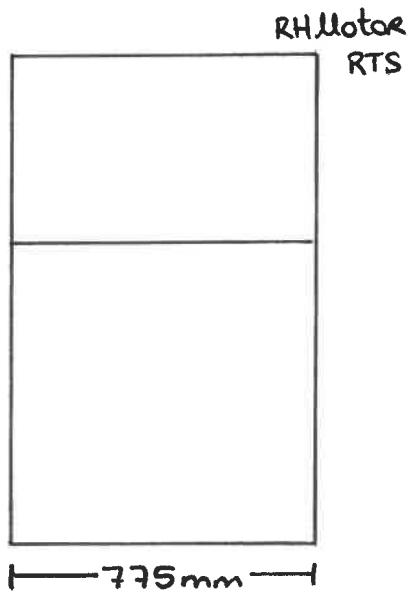

SG2195 (~~not updated system~~)
Fabric: Colorama Dimout 463
Custom-colour hardware (RAL
colour TBC)

Tamara Lopez-Dominguez

From: Jonathan Callen <jonathancallen@silentgliss.co.uk>
Sent: 31 October 2024 06:35
To: Tamara Lopez-Dominguez
Subject: RE: SG2195 Motorised skylight system

Follow Up Flag: Follow up
Flag Status: Flagged

Good morning Tamara

Please see revised pricing for the 2 x 2195 systems with the updated system change to cover more of the side tracks as below.

The uplift for the new system option is 30% on the hardware price.

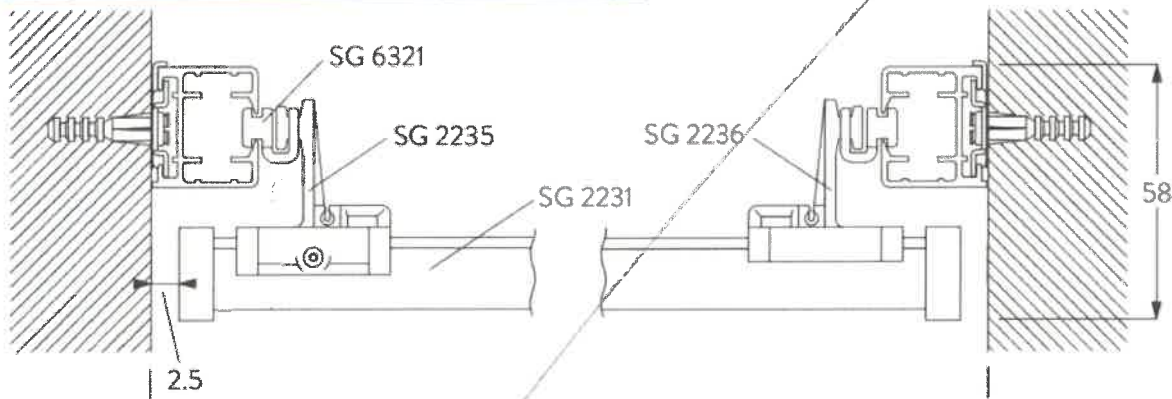
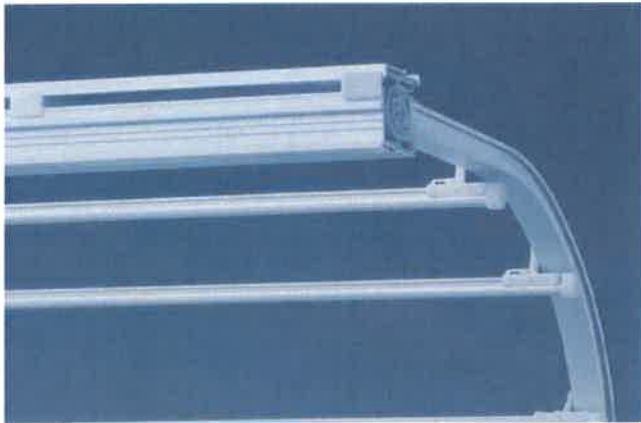

<u>1 x 720mm x 3860mm</u>				
Hardware	£4,546.39	-55% x 2.5 =	£5114.69	} £7192
Bends	£348.50	-25% x 2.5 =	£653.44	
Fabric	£920.61	-55% x 2.5 =	£1035.69	
9945 radio receiver 9945	£345.14	-55% x 2.5 =	£388.28	
Total	£6,160.64			

<u>1 x 1202mm x 2180mm</u>				
Hardware	£4,158.95	-55% x 2.5 =	£4678.82	} £6044
Fabric	£867.99	-55% x 2.5 =	£976.49	
9945 radio receiver 9945	£345.14	-55% x 2.5 =	£388.28	
Total	£5,372.08			

1 x 5 channel remote £280.63 → Remote

Grand total £11,813.35

Trade pricing

Bends £348.50 – 25%= £261.38

Systems £11,464.85- 55%= £5,159.19

Total £5,420.57

All the above are supply only and are excluding VAT.

We have a sample of the upgrade at our London studio and I will take some images as there tomorrow and will email them to you.

Kind regards

Jonathan

Jonathan Callen

Southern Area Manager

—
Silent Gliss Ltd.
Pyramid Business Park
Poorhole Lane
Broadstairs
Kent, CT10 2PT

T: +44 (0) 7764 252714 (direct)
www.silentgliss.co.uk

From: Tamara Lopez-Dominguez <Tamara@cpinteriors.je>

Sent: 30 October 2024 17:31

To: Jonathan Callen <jonathancallen@silentgliss.co.uk>

Subject: RE: SG2190

Hi,

Yes, both in the same room.

Kind Regards

Tamara
Lopez-Dominguez

Interior Design Advisor
tamara@cpinteriors.je

QUOTE 2195

Q U O T A T I O N

1/0966546

C P Interiors
Rue des Pres Trading Estate
Longueville
St Saviour
Jersey

11/12/24

INCOTERMS DAP

JE2 7QN

TAKEN BY- SALLYB

LINE	PROD	VERS	COLOUR	BRACKET	LOUVRE	STACK	QTY	UNIT	MTRS	TOTALS	DESCRIPTION	PRICE	CTG
====	====	====	=====	=====	=====	=====	===	=====	=====	=====	=====	=====	=====
a) {	1	2195	F	S			1	.775 X	3.855		SILVER ELECTRICALLY OPERATED WINTERGARDEN WITH FABRIC		C
							@4,486.87	EACH		= 4,486.87	**TO BE BENT** **TO BE SPRAYED TO RAL****-**		
										- 55% x 2.5 = £504.8			
	2	2190BD		1			1			1	2190 BENDING CHARGE. RADIUS 25-99CM		D
							@ 348.50	EACH		= 348.50			
										= 25% x 2.5 = £653.44			
b {	3	2195	F	S			1	1.075 X	2.190	1	SILVER ELECTRICALLY OPERATED WINTERGARDEN WITH FABRIC		C
							@3,979.03	EACH		= 3,979.03	**TO BE SPRAYED TO RAL****-**		
										- 55% x 2.5 = £4476.41			
a/b	4	9945					2			2	RECEIVER LATCHING 868MHZ		C
							@ 345.14	EACH		= 690.28	**ONLY STORES TO PICK**		
										- 55% x 2.5 = £388.28 each			
	5	10302			W		1			1	5+1 CHANNEL REMOTE WHITE 868 MHZ		C
							@ 280.62	EACH		= 280.62	*** ONLY STORES TO PICK ***		
										£281			
c {	6	SETUP					1			1	SETUP CHARGE		E
							@ 302.50	EACH		= 302.50	x 1.5 = £453.75		
	7	SPRAY			SA		1			1	SPRAYING CHARGE SATIN FINISH		E
							@ 177.44	EACH		= 177.44	x 1.5 = £266.16		
d {	8	6970	A	W			1	1.840		1	WHITE READY ASSEMBLED HAND DRAWN CURTAIN TRACK		A
							@ 308.18	EACH		= 308.18	**BEND AS PER PLOT**		

- 40% x 2.5 = £462.27

+ PTO (£330.94) = £793

C O N T I N U A T I O N P A G E

Q U O T A T I O N

C P Interiors
 Rue des Pres Trading Estate
 Longueville
 St Saviour
 Jersey INCOTERMS DAP

QUOTE DATE- 11/12/24
 TAKEN BY- SALLYB

QUOTE NO. - 1/0966546

LINE	PROD	VERS	COLOUR	BRACKET	LOUVRE	STACK	QTY	UNIT	MTRS	TOTALS	DESCRIPTION
====	====	====	=====	=====	=====	=====	===	=====		=====	=====
d { 9	6970BD	1					1			1	6970 BENDING CHARGE. RADIUS 25-99CM
							@ 176.50	EACH	=	176.50	-25% * 2.5 = £330.94
										GROSS QUOTATION VALUE :-	10,749.92
										NETT OF DISCOUNTS	5,274.35

Please excuse computerised print out - this is an instant response budget quotation.

①

2850

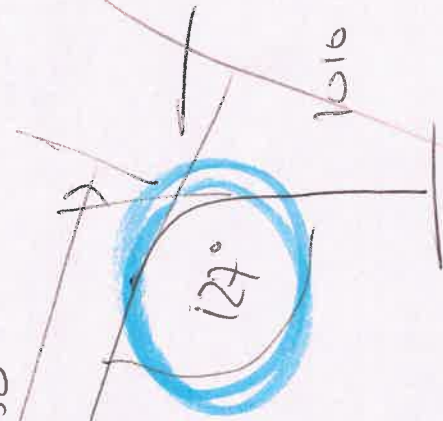

w. 720 plus TRADES

TRADES For Blo vellen
powder COATED SLACK

②

2180

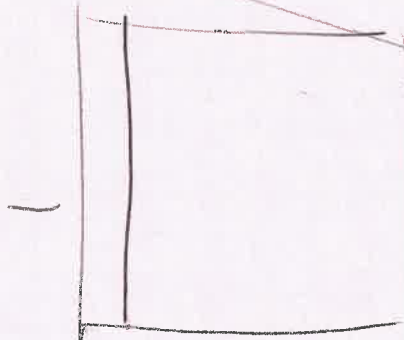

1020 plus TRADES

Staff Name: Adrian

Work Diary

Order No: SO15245
 Measurer: Measurer
 Contact Address: Mr. Ben Thomason, Dell Farm, La Rue Du Bocage, St Brélade, JE3 8BP,
 07825324126, 07829838787, ben.thomason@colliers.com

Customer Ref: Blinds and shutter

Date: 01-03-2024
 Time: 15:00

Notes: To go through quote with client as they want to finalise and order

Spacer de la ceom
 Primitive linen Garlic PAWZ
 140cm @ £150/pin

Location	Supplier	Blind Type /Description	Colour	Qty	Width	Drop	Fitting Height	Blind/Recess	Controls	Brackets	Surface	Unit Price
Lower Level window	Single	Single Curtain	RLB	1	1800	1200			RHS	FATH		
	Single	on telephone	"		T/W	F1/D						
	Recess	Pair "	Soft	1	2900	2350						
	Gable End	3 windows (part)			T/W	F1/D						
Dormer	Single	Single Curve		1	1400	2150			NHS	TSP		
	Recess	in			T/W	F1/D						
		profile → RT1E	1.5m	@	£66.91	20%	=	£120.08				£138.95
		FC35E	2*		£18.87			£18.87				
		(NO Room for Blind spacer Box)										
		Zip spacer		2	AS	duer						

Comments:

✗ hang with 15mm on floor

Order Date

Customer Signature

X
 I have checked and agree with the above choices

Targeting Date



CP INTERIORS

QUOTE

2pm
17h

5mm top
5mm bottom
25mm
colour

To:
Mr. Ben Thomason
Dell Farm
La Rue Du Bocage
St Brelade
JE3 8BP

Job Number: SO16273Q1
Customer Reference:
SG2195 System and Curtains

Quote Date: Friday 01 Nov 2024
Deposit required: £ 10,801.35
Your Contact: Tamara

Our Price Promise to you
We are so confident our pricing is competitive, that we will beat any written quotation for equivalent product by 5%

To supply and fit unless otherwise stated:

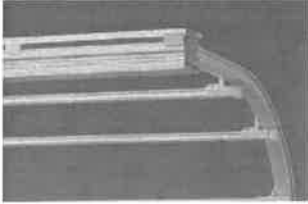
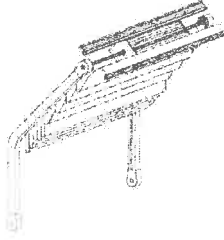
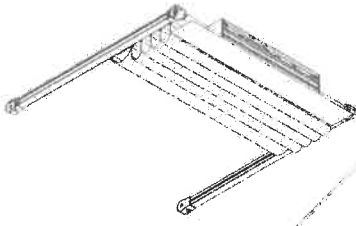
Location	Product	Description	Qty	Price
Master Bedroom Angled Window	Skylight	SG2195 motorised skylight system with bend in dimout colorama fabric (colour TBC), and white hardware. Custom colour hardware available on request (surcharge).	1	£ 7,192.00
				463 (colour)
				
				
Master Bedroom Sloped Window	Skylight	SG2195 motorised skylight system with bend in dimout colorama fabric (colour TBC), and white hardware. Custom colour hardware available on request (surcharge).	1	£ 6,044.00
				
	Accessories	5 channel remote to operated both SG2195,	1	£ 281.00
Dormer Window	Roller blind	100 Zip Roller Blind with fabric retention and slim side channels and a Luxury 46 hembar, in a C-Screen blackout fabric (colour TBC). Black hardware. Operated with a Somfy Sonesse 40 RTS motor.	1	£ 1,378.00
Low Horizontal Window	Roller blind	80 Zip Roller Blind with fabric retention and slim side channels and a Luxury 46 hembar, in a C-Screen blackout fabric (colour TBC). Black hardware. Operated with a Somfy Sonesse 40 RTS motor.	1	£ 1,195.00
	Accessories	Situo 5 remote,	1	£ 99.00
Gable End	Curtain Making	Hand finished pair of curtains, with a single pleat header and blackout lining.	1	£ 932.00
		This pair of curtains will cover the 3 windows on that end.		
Gable End	Curtain Pole / Track	SG7610 30mm Metropole, with flush or stud ends, in a Band B colour TBC. Hand operation and Face Fix	1	£ 493.00



Bedroom	Fabric	16m of De Le Cuona Primitive Linen Garlic PRIM2 @£185 per metre,	1	£ 2,960.00
	.	Subject to final measurements,	1	
	.	Electrical works not included,	1	

Terms: 40% deposit due with order, 40% on delivery & final 20% on completion

**** To go ahead with this quote please make deposit payment. To pay by card call us on 01534 768141 ****

Direct Deposit - Sort Code: 60-12-03 Account: 66577772

If you have any queries please call us on 01534 768141 or visit our showroom Rue des Pres Trading Estate St Saviour

**** For Our Terms & Conditions of Sale please go to www.cpinteriors.je ****

Subtotal	£ 20,574.00
GST	£ 1,028.70
Total	£ 21,602.70
Paid amount	£ 0.00
Total amount	£ 21,602.70

Please note: This quotation is only valid for acceptance for 7 days. Our estimate does not include any electrical work or additional carpentry work to install the above unless otherwise specified. Please note there is a handling charge on customer own fabric of £7.50 per metre. Due to high costs of labour, pre-arranged missed fitting appointments will be charged on a time-wasted basis. Settlement is due on completion of works and an administration charge of £25 will be added per month if unpaid within 30 days. We reserve the right to charge for design, advice and liaison work carried out should an order not be placed. Goods remain the property of CP Interiors until full settlement is received. Should payment not be received we reserve the right to attend premises during working hours to remove goods and not be required to make good. Our full terms and conditions apply and are available on request.



CP INTERIORS

QUOTE



To:
Mr. Ben Thomason
Dell Farm
La Rue Du Bocage
St Brelade
JE3 8BP

Job Number: SO16273
Customer Reference:
Zipped rollers and Curtains

Quote Date: Friday 01 Nov 2024
Deposit required: £ 7,428.23
Your Contact: Tamara

Our Price Promise to you
We are so confident our pricing is competitive, that we will beat any written quotation for equivalent product by 5%

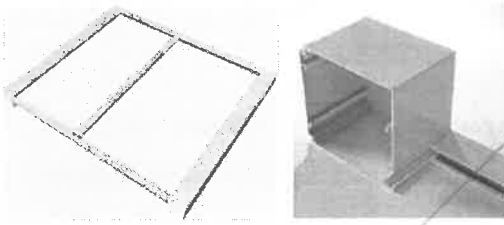
To supply and fit unless otherwise stated.

Location	Product	Description	Qty	Price
Angled Window (Sloped Part)	Roller blind	125 Zip Roller Blind with fabric retention and slim side channels and a type Z hembar, in a C-Screen blackout fabric (colour TBC). Black hardware. Operated with a Somfy Sonesse 40 RTS motor.	1	£ 2,925.00
				
Angled Window (Vertical Part)	Roller blind	100 Zip Roller Blind with fabric retention and slim side channels and a Luxury 46 hembar, in a C-Screen blackout fabric (colour TBC). Black hardware. Operated with a Somfy Sonesse 40 RTS motor.	1	£ 1,096.00
				
Sloped Window	Roller blind	125 Zip Roller Blind with fabric retention and slim side channels and a type Z hembar, in a C-Screen blackout fabric (colour TBC). Black hardware. Operated with a Somfy Sonesse 40 RTS motor.	1	£ 3,071.00
Low Horizontal Window	Roller blind	80 Zip Roller Blind with fabric retention and slim side channels and a Luxury 46 hembar, in a C-Screen blackout fabric (colour TBC). Black hardware. Operated with a Somfy Sonesse 40 RTS motor.	1	£ 1,195.00
Dormer Window	Roller blind	100 Zip Roller Blind with fabric retention and slim side channels and a Luxury 46 hembar, in a C-Screen blackout fabric (colour TBC). Black hardware. Operated with a Somfy Sonesse 40 RTS motor.	1	£ 1,378.00
	Accessories	Situo 5 remote,	1	£ 99.00
Gable End	Curtain Making	Hand finished pair of curtains, with a single pleat header and blackout lining.	1	£ 932.00

This pair of curtains will cover the 3 windows on that end.



Curtain Pole / Track	SG7610 30mm Metropole, with flush or stud ends, in a Band B colour TBC. Hand operation and Face Fix	1	£ 493.00
Fabric	16m of De Le Cuona Primitive Linen Garlic PRIM2 @£185 per metre,	1	£ 2,960.00

Subject to final measurements,

Electrical works not included,

Terms: 40% deposit due with order, 40% on delivery & final 20% on completion

**** To go ahead with this quote please make deposit payment. To pay by card call us on 01534 768141 ****

Direct Deposit - Sort Code: 60-12-03 Account: 66577772

If you have any queries please call us on 01534 768141 or visit our showroom Rue des Pres Trading Estate St Saviour

**** For Our Terms & Conditions of Sale please go to www.cpinteriors.je ****

Subtotal	£ 14,149.00
GST	£ 707.45
Total	£ 14,856.45
Paid amount	£ 0.00
Total amount	£ 14,856.45

Please note: This quotation is only valid for acceptance for 7 days. Our estimate does not include any electrical work or additional carpentry work to install the above unless otherwise specified. Please note there is a handling charge on customer own fabric of £7.50 per metre. Due to high costs of labour, pre-arranged missed fitting appointments will be charged on a time-wasted basis. Settlement is due on completion of works and an administration charge of £25 will be added per month if unpaid within 30 days. We reserve the right to charge for design, advice and liaison work carried out should an order not be placed. Goods remain the property of CP Interiors until full settlement is received. Should payment not be received we reserve the right to attend premises during working hours to remove goods and not be required to make good. Our full terms and conditions apply and are available on request.

Work Diary

Staff Name Adrian **Measurer or Fitter** Contact Address **Customer Ref** Foreman Nathan 07825324126 **Date** 29-11-2023 **Time** 09:00
Order No SO15245 **Measurer** Mr. Ben Thomason, Dell Farm, La Rue Du Bocage, St Breilade, JE3 8BP, 07829838787, ben.thomason@colliers.com

Notes: 0 To discuss options for blinds/shutters. Please get email address as well

Location	Supplier	Blind Type / Description	Colour	Qty	Width	Drop	Fitting Height	Blind/Recess	Controls	Brackets	Surface	Unit Price
Mrs Fox		Zip Screen	Bto									
Bed		roller	TRA									
		Custom										
		Colour Hardware TRA	possibly					Blade	TRA			
		Somfy RTS										
		2300 - 240 VHT										
		Nemote 4 channel										
1) slope window		AM plus		1	800	2800		A 65°C				
2) Slope "		blind system		1	1100	2800		A		6m	→ £1064.28	
3) Low "		100 x 100 to top		1	1500	700		A				
4) Dormer "		" - only		1	1500	1800		A		8 x endcaps =	£180.48	
		Plantation	Blade	1	860	1000	+ 2 UR	A				
		Shutter						BO FABRIC				
								BLIND Motor				
		Zip OBSCURA:										
		1) £447 + £238 = £685 + £16.24 = £701.24 × 2.5 = £1753										
		2) £474 + £238 = £712 + £22.38 = £734.38 × 2.5 = £1836										
		3) £317 + £238 = £555 + £7.61 = £562.61 × 2.5 = £1407										
		4) £392 + £238 = £630 + £19.58 = £649.58 × 2.5 = £1624										

Comments: Requested quote from Umbra
 Chased Umbra 12/12

Order Date _____ **Customer Signature** _____
 I have checked and agree with the above choices
 Target Fitting Date _____

Mr. Ben Thomason

**Dell Farm
La Rue Du Bocage
St Brelade
JE3 8BP**

Date	Reference	Your Contact
12-03-2024	SO15245Q1	Tamara
Customer Ref.		
Curtains		

Quote

Our Price Promise to you

We are so confident our pricing is competitive, that we will beat any written quotation for equivalent product by 5%

Supply & Fit/Supply Only

Location	Description	QTY	Price
Lower Level Window	Curtain Making, Hand finished single curtain, with a single pleat header and blackout lining.	1	£ 573.00
	Curtain Pole / Track, SG7610 30mm Metropole, with flush or stud ends, in a Band B colour TBC. Hand operation and Face Fix	1	£ 347.00
Gable End	Curtain Making, Hand finished pair of curtains, with a single pleat header and blackout lining.	1	£ 932.00
	This pair of curtains will cover the 3 windows on that end. Curtain Pole / Track, SG7610 30mm Metropole, with flush or stud ends, in a Band B colour TBC. Hand operation and Face Fix	1	£ 493.00
Dormer	Curtain Making, Hand finished single curtain, with a single pleat header and blackout lining.	1	£ 460.00
	Curtain Pole / Track, SG6970 in white, with standard gliders. Hand operation.	1	£ 273.00
Bedroom	To be fitted inside a recess profile (on a separate quote) Curtain track recess profile fitting brackets, TTSG1 Fixing Brackets for Silent Gliss track inside a Reese recess profile,	6	£ 31.26
	Fabric, 29.5m of De Le Cuona Primitive Linen Garlic PRIM2 @£150 per metre,	1	£ 4,425.00

Terms : 50% deposit due with order, 50% on completion

BACS Payment		Phone and Card Payment	Subtotal : £ 7,534.26
Bank: NatWest		Payment can be made in person or by phone.	
Sort Code: 60 12 03		If phone, please call us on 01534 768141 and have your card details ready.	
Account No: 66577772		Note, we do not accept American Express or Cheque payments.	GST : £ 376.71
Carpet Protection (C.I) Ltd T/A CP Interiors			Total : £ 7,910.97

Please note: This quotation is only valid for acceptance for 14 days. Our estimate does not include any electrical work or additional carpentry work to install the above unless otherwise specified. Please note there is a handling charge on customer own fabric of £7.50 per metre. Due to high costs of labour, pre-arranged missed fitting appointments will be charged on a time-wasted basis. Settlement is due on completion of works and an administration charge of £25 will be added per month if unpaid within 30 days. We reserve the right to charge for design, advice and liaison work carried out should an order not be placed. Goods remain the property of CP Interiors until full settlement is received. Should payment not be received we reserve the right to attend premises during working hours to remove goods and not be required to make good. Our full terms and conditions apply and are available on request.



PREMIERCHOICE

MANUFACTURERS OF QUALITY CUSTOM MADE CURTAINS, PELMETS AND BLINDS

CP INTERIORS JERSEY
 CP INTERIORS
 RUE DES PRES TRADING ESTATE
 ST SAVIOUR
 JERSEY
 JE2 7QN

Re: 5136 / 1 - SO15245 THOMASON

07 March 2024

Dear Customer,

THIS IS AN ESTIMATE ONLY. SHOULD YOU WISH TO PLACE AN ORDER KINDLY SEND A DETAILED WORKSHEET WHERE POSSIBLE USING THE PREMIER CHOICE ORDER FORM TO orders@premierchoice.co.uk

We thank you for your enquiry and we have the pleasure in estimating you as follows:

SINGLE CURTAIN

1 Curtain Single Pinch Pleat, Hand Finished Lined	£	229.32	
Rail size of 200cm, Drop of 120cm, Overall rail size: 200cm, 3.5 Widths in each			
Making:	4	Widths	
Fabric: 00cm pattern repeat	6	mts	£573
Lining: Blackout Lining	6	mts	

PAIR

1 Pair of Curtains Single Pinch Pleat, Hand Finished Lined	£	372.96	
Rail size of 310cm, Drop of 235cm, Overall rail size: 310cm, 3 Widths in each			
Making:	6	Widths	
Fabric: 00cm pattern repeat	15.9	mts	£932
Lining: Blackout Lining	15.9	mts	

SINGLE CURTAIN

1 Curtain Single Pinch Pleat, Hand Finished Lined	£	184.17	
Rail size of 160cm, Drop of 215cm, Overall rail size: 160cm, 3 Widths in each			
Making:	3	Widths	
Fabric: 00cm pattern repeat	7.4	mts	£460
Lining: Blackout Lining	7.4	mts	

Others Subtotal: £ 786.45

Total: £ 786.45

30mm Graphite Metropole
 (not standard)

1800mm 231.53 - 40% x 2.5 = £347

2900mm £328.66 - 40% x 2.5 = £493

SGG970 1400mm £155.59 - 40% x 2.5 = £40 = £273

TTS61 (4x per metre) @ £5.21 each

Any additional work/material, not mentioned in the above estimate, will be invoiced for. Please note all Velvet fabrics are subject to 10% surcharge as per price list.

THIS IS AN ESTIMATE ONLY.

SHOULD YOU WISH TO PLACE AN ORDER KINDLY SEND A DETAILED WORKSHEET WHERE POSSIBLE USING THE PREMIERCHOICE ORDER FORM.

ALL EMAILED ORDERS PLEASE EMAIL TO ORDERS@PREMIERCHOICE.CO.UK
PLEASE QUOTE ESTIMATE NUMBER SUPPLIED.

Lead Times are subject to availability.

Assuring you of our best attention at all times.

E. & O.E

Yours Faithfully
SallyWaddilove
Premierchoice Ltd

Quote

Q32214-51036



Customer: CP Interiors **Quote Date:** 14/12/2023

Customer Ref.: SO15245 Ben Thomasson

Contact Name: Tamara Lopez-Dominguez

System	Ref. No.	Finish d Width	Finish d Drop	Operation	Fabric Joins	Tube Dia.	Hem Bar	Hem Bar Colour	Hardware Colour	Fabric		Type	Shape	Channel/Brac ket Type	Bottom Angle	Cust. Ref	Notes	Unit RRP	Unit Price	Qty	Total
										Type	Colour										
Helios RL	1	800	2800	Radio - RTS - Somfy Sonnesse 40 6/20	0	65	Z	Black	Black	C Screen - 3m - BO	TBC	Fascia	Square	No Channels	No		Sloping window	£1,599.56	£767.79	1	£767.79
Helios RL	2	1100	2800	Radio - RTS - Somfy Sonnesse 40 6/20	0	65	Z	Black	Black	C Screen - 3m - BO	TBC	Fascia	Square	No Channels	No	2	Sloping window	£1,667.96	£800.62	1	£800.62
Helios	3	1500	700	Radio - RTS - Somfy Sonnesse 40 6/20	0	52	1	White	White	C Screen - 3m - BO	TBC			Guidewire Cill	No	3		£716.66	£379.83	1	£379.83
Helios RL	4	800	1800	Radio - RTS - Somfy Sonnesse 40 6/20	0	65	Z	Black	Black	C Screen - 3m - BO	TBC	Fascia	Square	No Channels	No	4	Sloping window	£1,549.69	£743.85	1	£743.85
																	Blinds total		4	£2,692.09	

Special Notes

Delivery Address

Please note that we have not included for any controls in the above quotation. These can be found on the following link: <https://umbrashading.co.uk/pricing/>

Spectrum Supply via Umbra, 31 Ystrad Road, Swansea West, Business Park, Swansea, SA5 4BT
Tel: 01792 562015 E-mail: sales@umbrashading.co.uk

The above sizes are blind sizes which will be used for manufacture
The above pricing excludes VAT

Please note that the above pricing is based on this quotation being ordered in full on a single purchase order. Should you require these blinds in phases please discuss this with us as it may affect the pricing.

Quote

Q32214-51036



Customer: CP Interiors
Contact Name: Tamara Lopez-Dominguez

Order Date: 14/12/2023
Customer Ref.: SO15245 Ben Thomasson

Total Quantity: 4
Total Price: £2,705.34

Part No	Details	Length	Unit RRP	Unit Price	Quantity	Total Price
	Standard Carriage		£13.25	£13.25	1	£13.25
Parts total:						£13.25
Blinds total:						£2,692.09
Grand total:						£2,705.34

Special Notes Delivery Address

Please note that we have not included for any controls in the above quotation. These can be found on the following link: <https://umbrashading.co.uk/pricing/>

Spectrum Supply via Umbra, 31 Ystrad Road, Swansea West Business Park, Swansea, SA5 4BT
Tel: 01792-562015 E-mail: sales@umbrashading.co.uk

The above sizes are blind sizes which will be used for manufacture
The above pricing excludes VAT

Please note that the above pricing is based on this quotation being ordered in full on a single purchase order. Should you require these blinds in phases please discuss this with us as it may affect the pricing.

Shutters - Cuba

Freight Method **Sea** **OD** Air **Hide Breakdown**

#	ROOM	COLOUR	WIDTH	HEIGHT	TYPE	MIDRAIL	LOUVRE	TILT	LAYOUT	FRAME	STILE	HINGE COLOUR	BATTENS	STATUS	ACTIONS
2	Master Bedroom	Custom colour	860	1000	Full Height	63mm	Silent Tilt	LR	Plain L Frame 46mm	41.3mm Flat D-Mould Stile	Black	Batten, 3 x 15 QTY 2	Batten, 3 x 15 QTY 1	Details complete	  

Shutters - Cuba - Breakdown

#	BASIC PANEL	BATTENS	TILT CONTROL	TRADE ITEMS TOTAL	TRADE DISCOUNTED PRICE	CUSTOM COLOUR	NON DISCOUNTABLE TOTAL
2	£191.39	£14.72	£20.01	£226.12	£252.45	£122.43	£122.43

£631.13 + £122.43 = £754

Shutters - Fiji

Freight Method Sea Air  Hide Breakdown

#	ROOM	COLOUR	WIDTH	HEIGHT	TYPE	MIDRAIL	LOUVRE	TILT	LAYOUT	FRAME	STILE	HINGE COLOUR	BATTENS	STATUS	ACTIONS
1	Master Bedroom	Stain - Matte Black	860	1000	Full Height	63mm	Silent Tilt	LR	Plain L Frame 46mm	41.3mm Flat D-Mould Stile	Black	Batten, 3 x 15 QTY 2 Batten, 3 x 15 QTY 1	Details complete	  	

Shutters - Fiji - Breakdown

#	BASIC PANEL	TILT CONTROL	BATTENS	TRADE ITEMS TOTAL	TRADE DISCOUNTED PRICE	COLOUR	CUSTOM COLOUR	NON DISCOUNTABLE TOTAL
1	£234.28	£20.01	£14.72	£269.01	£277.11	£122.43	£0.00	£122.43

£692.78 + £122.43 = £815

SC231110074 - CP Interiors



Order Notes

Created by	Tamara Lopez-Dominguez	Customer Information	Delivery Information
Group Order No	SC231110074	Title	Address Line 1
SC Order No	N/A	First Name	Address Line 2
Total Shutter SQ/M	1.72	Last Name	Address Line 3
Freight Method		Order Reference	Postcode

#1 Room	Master Bedroom	Range	Shutters - Fiji	Colour	Stain - Matte Black	Width	860mm	Height	1000mm	Shutter Type	Full Height
Additional Shutter Options											
Midrail & Louvre		Panel type	Regular			Split Position	mm	Split Position 2	mm		
Layout		Midrail	None	Louvre	63mm	Tilt control		Silent Tilt			
Config	LR										
Frame Options		Frame	Plain L Frame	46mm	Build out	None					
Stile & Hinge		Stile	41.3mm Flat D-Mould	Stile	Hinge type	Standard Hinge	Hinge colour	Black			
Fitted hardware		Side magnets	False	Roof Catch	False						
Batten #1		Type	Batten, 3 x 15	Colour	Stain - Matte Black	Width	3mm	Depth	15mm	Length	1100mm
Batten #2		Type	Batten, 3 x 15	Colour	Stain - Matte Black	Width	3mm	Depth	15mm	Length	960mm
Notes										Qty	2
										Qty	1

#2 Room	Master Bedroom	Range	Shutters - Cuba	Colour	Custom colour - Black	Width	860mm	Height	1000mm	Shutter Type	Full Height
Additional Shutter Options											
Midrail & Louvre		Panel type	Regular			Split Position	mm	Split Position 2	mm		
Layout		Midrail	None	Louvre	63mm	Tilt control		Silent Tilt			
Config	LR										
Frame Options		Frame	Plain L Frame	46mm	Build out	None					
Stile & Hinge		Stile	41.3mm Flat D-Mould	Stile	Hinge type	Standard Hinge	Hinge colour	Black			
Fitted hardware		Side magnets	False	Roof Catch	False						
Batten #1		Type	Batten, 3 x 15	Colour	Custom colour	Width	3mm	Depth	15mm	Length	1100mm
Batten #2		Type	Batten, 3 x 15	Colour	Custom colour	Width	3mm	Depth	15mm	Length	960mm
Notes										Qty	2
										Qty	1

Ben Thomason

Dell Farm
La Rue Du Bocage
St Brelade
JE3 8BP

Date	Reference	Your Contact
20-12-2023	SO15245	Tamara
Customer Ref.		
Blinds and shutter		

Quote

Need to add Blind Pack Cost

Our Price Promise to you
We are so confident our pricing is competitive, that we will beat any written quotation for equivalent product by 5%

Supply & Fit/Supply Only

Location	Description	QTY	Price
Master Bedroom	Supply & Fit- Plantation Shutter, Premium Cuba hardwood full height shutter panels, with 63mm louvres and silent tilt mechanism, finished in a black custom colour including frames and trimmings to cover uneven windows if required. 1 window 2	1	£ 754.00
Master Bedroom Sloped Window 1	Supply & Fit- Roller blind, Zip Obscura Gravity roller blind, in a blackout fabric of your choice, white hardware and side channels. Operated with a Somfy Sonesse 40 RTS hardwired motor.	1	£ 1,753.00
Master Bedroom Sloped Window 2	Supply & Fit- Roller blind, Zip Obscura Gravity roller blind, in a blackout fabric of your choice, white hardware and side channels. Operated with a Somfy Sonesse 40 RTS hardwired motor.	1	£ 1,836.00
Master Bedroom Low Window 2	Supply & Fit- Roller blind, Zip Obscura Gravity roller blind, in a blackout fabric of your choice, white hardware and side channels. Operated with a Somfy Sonesse 40 RTS hardwired motor.	1	£ 1,407.00
Master Bedroom Low Dormer Window	Supply & Fit- Roller blind, Zip Obscura Gravity roller blind, in a blackout fabric of your choice, white hardware and side channels. Operated with a Somfy Sonesse 40 RTS hardwired motor.	1	£ 1,624.00
	All blinds to be fitted inside recess boxing, Supply only- Situo 5 remote, Electrical works not included, Subject to final measurements, For the Plantation Shutters, delivery is approximately 10-12 weeks from the time of placing your order. An airfreight service is available to you at an extra cost reducing the delivery time to an average of 5 to 6 weeks. An accurate costing may be given on request.	1	£ 80.00

Terms : 50% deposit due with order, 50% on completion

BACS Payment	
Bank:	NatWest
Sort Code:	60 12 03
Account No:	66577772
Carpet Protection (C.I) Ltd T/A CP Interiors	

Phone and Card Payment
Payment can be made in person or by phone. If phone, please call us on 01534 768141 and have your card details ready. Note, we do not accept American Express or Cheque payments.

Subtotal :	£ 7,454.00
GST :	£ 372.70
Total :	£ 7,826.70

Please note: This quotation is only valid for acceptance for 14 days. Our estimate does not include any electrical work or additional carpentry work to install the above unless otherwise specified. Please note there is a handling charge on customer own fabric of £7.50 per metre. Due to high costs of labour, pre-arranged missed fitting appointments will be charged on a time-wasted basis. Settlement is due on completion of works and an administration charge of £25 will be added per month if unpaid within 30 days. We reserve the right to charge for design, advice and liaison work carried out should an order not be placed. Goods remain the property of CP Interiors until full settlement is received. Should payment not be received we reserve the right to attend premises during working hours to remove goods and not be required to make good. Our full terms and conditions apply and are available on request.

2 De Po Courne
SARUc IRES?



CP INTERIORS

Ben Thomason

Dell Farm
La Rue Du Bocage
St Brelade
JE3 8BP

Date	Reference	Your Contact
20-12-2023	SO15245	Tamara
Customer Ref.		
Blinds and shutter		

Quote

Need to Add Blind Price Cost

Our Price Promise to you
We are so confident our pricing is competitive, that we will beat any written quotation for equivalent product by 5%

Supply & Fit/Supply Only

Location	Description	QTY	Price
Master Bedroom	Supply & Fit- Plantation Shutter, Premium Cuba hardwood full height shutter panels, with 63mm louvres and silent tilt mechanism, finished in a black custom colour including frames and trimmings to cover uneven windows if required. 1 window 2	1	£ 754.00
Master Bedroom Sloped Window 1	Supply & Fit- Roller blind, Zip Obscura Gravity roller blind, in a blackout fabric of your choice, white hardware and side channels. Operated with a Somfy Sonesse 40 RTS hardwired motor.	1	£ 1,753.00
Master Bedroom Sloped Window 2	Supply & Fit- Roller blind, Zip Obscura Gravity roller blind, in a blackout fabric of your choice, white hardware and side channels. Operated with a Somfy Sonesse 40 RTS hardwired motor.	1	£ 1,836.00
Master Bedroom Low Window 2	Supply & Fit- Roller blind, Zip Obscura Gravity roller blind, in a blackout fabric of your choice, white hardware and side channels. Operated with a Somfy Sonesse 40 RTS hardwired motor.	1	£ 1,407.00
Master Bedroom Dormer Window	Supply & Fit- Roller blind, Zip Obscura Gravity roller blind, in a blackout fabric of your choice, white hardware and side channels. Operated with a Somfy Sonesse 40 RTS hardwired motor.	1	£ 1,624.00
	All blinds to be fitted inside recess boxing,		
	Supply only- Situio 5 remote,	1	£ 80.00
	Electrical works not included,		
	Subject to final measurements,		
	For the Plantation Shutters, delivery is approximately 10-12 weeks from the time of placing your order. An airfreight service is available to you at an extra cost reducing the delivery time to an average of 5 to 6 weeks. An accurate costing may be given on request.		

5 x 4
era
3 window
1 x curtain

Best Roller

Rose + Cuba

Terms : 50% deposit due with order, 50% on completion

BACS Payment		Phone and Card Payment		Subtotal : £ 7,454.00	
Bank:	NatWest	Payment can be made in person or by phone.			
Sort Code:	60 12 03	If phone, please call us on 01534 768141 and have your card details ready.			
Account No:	66577772	Note, we do not accept American Express or Cheque payments.		GST : £ 372.70	
Carpet Protection (C.I) Ltd T/A CP Interiors				Total : £ 7,826.70	

Please note: This quotation is only valid for acceptance for 14 days. Our estimate does not include any electrical work or additional carpentry work to install the above unless otherwise specified. Please note there is a handling charge on customer own fabric of £7.50 per metre. Due to high costs of labour, pre-arranged missed fitting appointments will be charged on a time-wasted basis. Settlement is due on completion of works and an administration charge of £25 will be added per month if unpaid within 30 days. We reserve the right to charge for design, advice and liaison work carried out should an order not be placed. Goods remain the property of CP Interiors until full settlement is received. Should payment not be received we reserve the right to attend premises during working hours to remove goods and not be required to make good. Our full terms and conditions apply and are available on request.

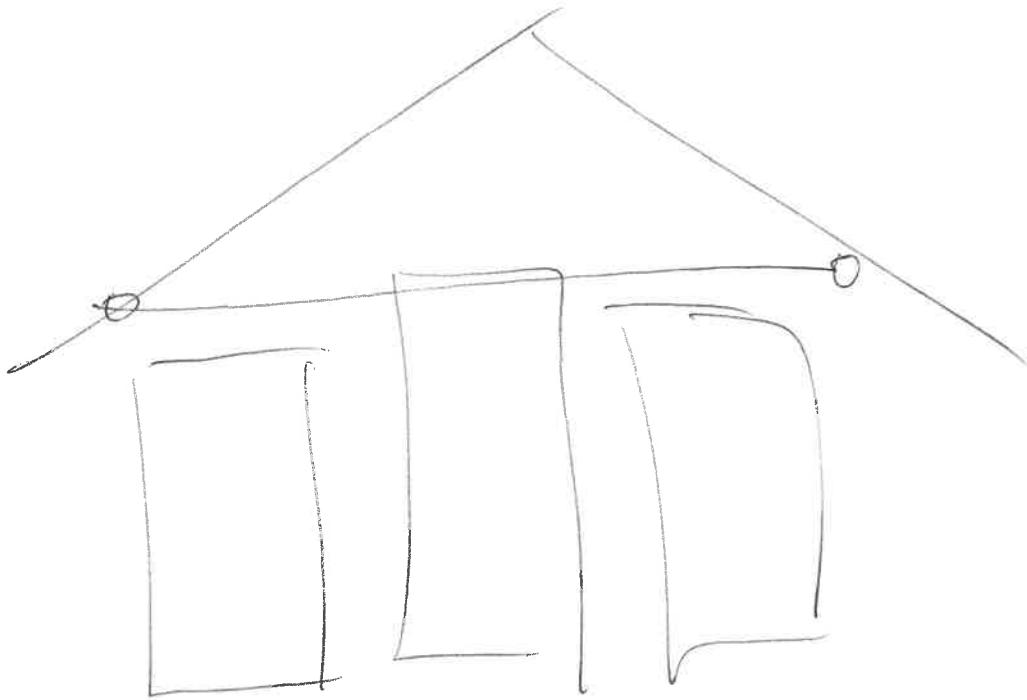

Mr. Ben Thomason

**Dell Farm
La Rue Du Bocage
St Brelade
JE3 8BP**

Date	Reference	Your Contact
15-03-2024	SO15521	Tamara
Customer Ref.		

Quote

Our Price Promise to you
We are so confident our pricing is competitive, that we will beat any written quotation for equivalent product by 5%

Supply & Fit/Supply Only

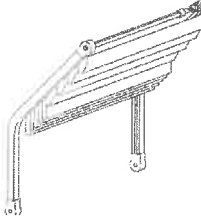
Location	Description	QTY	Price
	Skylight, Silent Gliss SG2190 electrically operated skylight shading system with bend in dimout colorama fabric, colour tbc 	1	£ 7,149.00
	Skylight, Silent Gliss SG2190 electrically operated skylight shading system in dimout colorama fabric, colour tbc	1	£ 6,282.00
	Electrical Parts, Parts required if to be operated by remote control, Electrical works not included,	1	£ 1,455.00

Terms : 40% deposit due with order, 40% on delivery & final 20% on completion

BACS Payment	
Bank:	NatWest
Sort Code:	60 12 03
Account No:	66577772
Carpet Protection (C.I) Ltd T/A CP Interiors	

Phone and Card Payment
Payment can be made in person or by phone. If phone, please call us on 01534 768141 and have your card details ready. Note, we do not accept American Express or Cheque payments.

Subtotal :	£ 14,886.00
GST :	£ 744.30
Total :	£ 15,630.30

Please note: This quotation is only valid for acceptance for 14 days. Our estimate does not include any electrical work or additional carpentry work to install the above unless otherwise specified. Please note there is a handling charge on customer own fabric of £7.50 per metre. Due to high costs of labour, pre-arranged missed fitting appointments will be charged on a time-wasted basis. Settlement is due on completion of works and an administration charge of £25 will be added per month if unpaid within 30 days. We reserve the right to charge for design, advice and liaison work carried out should an order not be placed. Goods remain the property of CP Interiors until full settlement is received. Should payment not be received we reserve the right to attend premises during working hours to remove goods and not be required to make good. Our full terms and conditions apply and are available on request.



CP INTERIORS

Mr. Ben Thomason

Dell Farm
La Rue Du Bocage
St Brelade
JE3 8BP

Date	Reference	Your Contact
15-03-2024	SO15521	Tamara

Customer Ref.

Quote

Our Price Promise to you
We are so confident our pricing is competitive, that we will beat any written quotation for equivalent product by 5%

Supply & Fit/Supply Only

Location	Description	QTY	Price
	Skylight, Silent Gliss SG2190 electrically operated skylight shading system with bend in dimout colorama fabric, colour tbc	1	£ 7,149.00
	Skylight, Silent Gliss SG2190 electrically operated skylight shading system in dimout colorama fabric, colour tbc	1	£ 6,282.00
	Electrical Parts, Parts required if to be operated by remote control, Electrical works not included,	1	£ 1,455.00

Terms : 40% deposit due with order, 40% on delivery & final 20% on completion

Subtotal : £ 14,886.00

BACS Payment

Bank: NatWest
Sort Code: 60 12 03
Account No: 66577772

Carpet Protection (C.I) Ltd T/A CP Interiors

Phone and Card Payment

Payment can be made in person or by phone.
If phone, please call us on 01534 768141 and have your card details ready.
Note, we do not accept American Express or Cheque payments.

GST : £ 744.30

Total : £ 15,630.30

Please note: This quotation is only valid for acceptance for 14 days. Our estimate does not include any electrical work or additional carpentry work to install the above unless otherwise specified. Please note there is a handling charge on customer own fabric of £7.50 per metre. Due to high costs of labour, pre-arranged missed fitting appointments will be charged on a time-wasted basis. Settlement is due on completion of works and an administration charge of £25 will be added per month if unpaid within 30 days. We reserve the right to charge for design, advice and liaison work carried out should an order not be placed. Goods remain the property of CP Interiors until full settlement is received. Should payment not be received we reserve the right to attend premises during working hours to remove goods and not be required to make good. Our full terms and conditions apply and are available on request.

📍 Rue des Pres Trading Estate, St. Saviour, Jersey, JE2 7QN 📞 01534 768141 🌐 www.cpinteriors.je
Blinds | Curtains | Awnings | Shutters | Fabrics | Wallpapers | Furnishings | Interior Design

Leeana Taft

From: Sally Brown <SallyBrown@SilentGliss.co.uk>
Sent: 14 March 2024 15:36
To: Leeana Taft
Cc: Jonathan Callen
Subject: RE: Quote ref: SO15245

Hi Leeana,

The price quoted was just for standard electric set up.

If you want the skylights to be controlled by remotes you would need to add:

1 x receiver for each blind (9945) £345.14 retail exc. VAT

Also, would need to add remotes, the quantity would depend on whether they are in the same room or not?

1 x 10300 (single channel) or 10302 (5 channel) each £280.63 retail exc. VAT

Many thanks,

Sally Brown

Senior Sales Co-Ordinator

—
Silent Gliss Ltd.
Pyramid Business Park
Poorhole Lane
Broadstairs
Kent, CT10 2PT

T: +44 (0)1843 874218 (direct)
www.silentgliss.co.uk

From: Leeana Taft <Leeana@cpinteriors.je>
Sent: Thursday, March 14, 2024 3:26 PM
To: Sally Brown <SallyBrown@SilentGliss.co.uk>
Cc: Jonathan Callen <jonathancallen@silentgliss.co.uk>
Subject: RE: Quote ref: SO15245

Great, sorry but does that include the remote control? And do you have a sales brochure for the customer?

Thank you!

Kind regards,

Leeana
Taft

Director
leeana@cpinteriors.je



Unit 28 Rue Des Pres Trading Estate
St Saviour
Jersey
JE2 7QN

01534 768141 | www.cpinteriors.je



With our CP Price promise, we will beat ar
** On like for like products only

From: Sally Brown <SallyBrown@SilentGliss.co.uk>
Sent: Thursday, March 14, 2024 3:09 PM
To: Leeana Taft <Leeana@cpinteriors.je>
Cc: Jonathan Callen <jonathancallen@silentgliss.co.uk>
Subject: RE: Quote ref: SO15245

Hi Leeana,

Yes, this is for electric operation.

Many thanks,

Sally Brown

Senior Sales Co-Ordinator

Silent Gliss Ltd.
Pyramid Business Park
Poorhole Lane
Broadstairs
Kent, CT10 2PT

T: +44 (0)1843 874218 (direct)
www.silentgliss.co.uk

From: Leeana Taft <Leeana@cpinteriors.je>
Sent: Thursday, March 14, 2024 3:07 PM
To: Sally Brown <SallyBrown@SilentGliss.co.uk>
Cc: Jonathan Callen <jonathancallen@silentgliss.co.uk>
Subject: RE: Quote ref: SO15245

Thank you

Is that electric operation?

Kind regards,

Leeana
Taft

Director
leeana@cpinteriors.je



Unit 28 Rue Des Pres Trading Estate
St Saviour
Jersey
JE2 7QN
01534 768141 | www.cpinteriors.je
 



With our CP Price promise, we will beat ar
** On like for like products only

From: Sally Brown <SallyBrown@SilentGliss.co.uk>
Sent: Thursday, March 14, 2024 2:14 PM
To: Leeana Taft <Leeana@cpinteriors.je>
Cc: Jonathan Callen <jonathancallen@silentgliss.co.uk>
Subject: RE: Quote ref: SO15245

Hi Leeana,

Thank you for your email.

Please see pricing below. I have allowed for Colorama Dimout fabric as this is a near blackout as we can go on the skylight systems. Attached the fabric card above for your info.

720mm x 3860mm	Retail exc. VAT	1202mm x 2180mm	Retail exc. VAT
Hardware:	3497.22	Hardware:	3320.99
Bends:	348.50	Fabric:	867.99
Fabric:	920.61	Total:	4188.98
Total:	£4766.33		

Any further questions, please come back to me.

Kind regards,

Sally Brown

Senior Sales Co-Ordinator

Silent Gliss Ltd.
Pyramid Business Park
Poorhole Lane
Broadstairs
Kent, CT10 2PT

T: +44 (0)1843 874218 (direct)
www.silentgliss.co.uk

From: Leeana Taft <Leeana@cpinteriors.je>
Sent: Wednesday, March 13, 2024 4:45 PM
To: Sally Brown <SallyBrown@SilentGliss.co.uk>
Subject: Quote ref: SO15245

Work Diary

Staff Name: Adrian

Order No: SO15246
 Measurer or Fitter: Mr. Ben Thomason, Dell Farm, La Rue Du Bocage, St Brelade, JE3 8BP, 07825324126, 07829838787, ben.thomason@colliers.com
 Contact Address: Blinds and shutter
 Customer Ref: Primitive Linen Garlic PR1M2
 Date: 01-03-2024
 Time: 15:00

Notes: To go through quote with client as they want to finalise and order

Spacer de la Courne
 140cm @ £150 p/m

Location	Supplier	Blind Type / Description	Colour	Qty	Width	Drop	Fitting Height	Blind/Recess	Controls	Brackets	Surface	Unit Price
Lower Level Windows	Single Curtain	Black	1	1800	1200				RHS	Fast		
	on Velcro			T/W	F/D		*					
	3mm	Spacer Track										
	Pair		1	2900	2350		#					
	Gable End 3 Windows (pair)			T/W	F/D							
Dormer	Single Curtain		1	1400	2150				RHS	TOP		
	in Reuse			T/W	F/D							
	profile → RTIF 1.5m @ £66.71 + 20% = £120.06											£132.95
	FC35E 2x											£18.87
	(NO ROOM for Blind SPARE Box)											
	Zip closure		2	AS	over							

* hang with 15mm on floor

Comments:

Order Date: _____

Customer Signature: _____

I have checked and agree with the above choices

Target Fitting Date: _____

Sibut

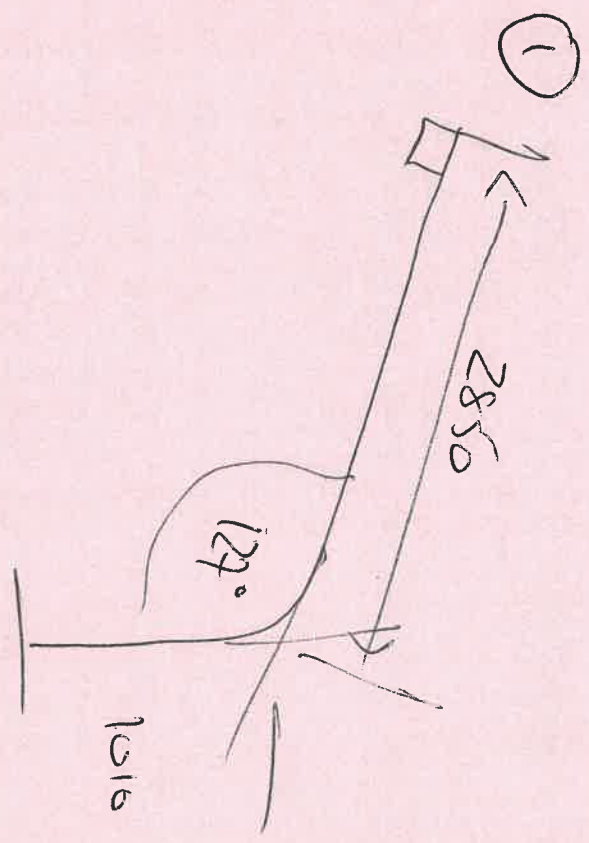

w. 720 plus tracks

Tracks for 810 rollers
provide constant slack

Electric

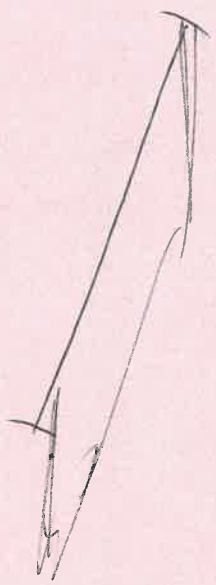
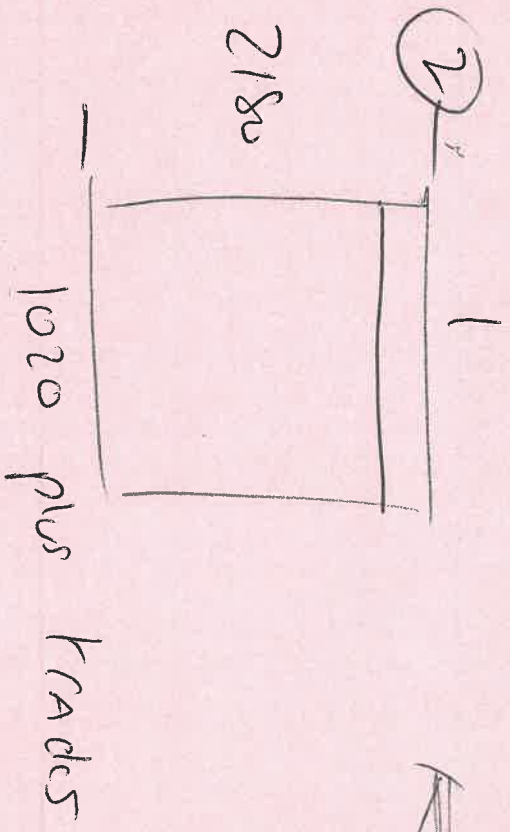

CONTENTS

- 2 Introduction
- 3 Introduction continued
- 4 TESS™ 100 series – Internal tension shading
- 5 TESS™ 200 – Large internal tension system
- 6 TESS™ 300 series – Internal vertical roller blind
- 8 TESS™ 400 series – External tension system
- 9 TESS™ 512 – Internal and external pergola system
- 10 TESS™ 600/640/601/602 – Compact tension system
- 11 TESS™ 660 – Blackout zip tension system
- 12 Other systems and spare parts

All prices valid until 31st December 2023

MOTORS AND CONTROLS

- All TESS™ system prices include a 240V tubular motor with manual limit setting. Radio controlled motors are available for an additional fee, see options on this page.
- Remote control hand sets are available for radio-controlled motors at additional cost, in single channel and multichannel versions, see options on this page.

POWDER COATING

- All TESS™ system prices include powder coating of exposed aluminum and carbon steel parts to RAL 9016 traffic white at 30% gloss level.
- The following colours are examples of available alternative CAT. A colours which incur an additional setup charge. CAT. B colours incur an additional charge per system. Download our list of RAL colour categories [here](#) from our website.

Examples of CAT. A colours

- RAL 7015 30% slate grey
- RAL 7031 30% blue grey
- RAL 9001 30% cream
- RAL 9005 30% jet black

PACKING AND DELIVERY

- For all delivery options and prices, including triwall cardboard boxes, wooden crates or dedicated vehicles, standard delivery or express delivery, please contact sales@guthriedouglas.com.

MANUFACTURING AND DELIVERY TIMES

- The standard manufacturing time is 4-6 weeks, to the point when goods are packed and ready for transport.
- Manufacturing will only start after receipt of a fully complete Guthrie Douglas order form, a customer purchase order number and any pre-payments if required.

OPTIONS

Listed below are some of the additional available options. For further information and options, please contact our sales department.

Guthrie Douglas specialist or blackout fabric (for TESS™100 series, TESS™400 series and TESS™ 600 series)	£ 63.80	
Hirschmann plug & socket	£24.45	
Radio control motor surcharge (TESS™ 100 series, TESS™ 308 and TESS™ 400 series)	£ 66.25	per TESS™ System
Radio control motor surcharge (TESS™ 200, TESS™ 312 and TESS™ 512)	£109.05	
Radio control motor surcharge for TESS™ 600 series 1 channel Somfy handset	no surcharge £51.30	
4+1 channel Somfy handset	£78.60	per controller (for radio controlled motor)
1 channel Somfy wall switch	£57.20	
Supplement for powder coat CAT. A from standard RAL colour list	£292.50	per order

TESS™ 660

TESS™ 660 BLACKOUT ZIP TENSION SYSTEM

Zero light gap tension screen

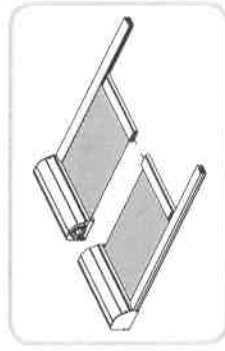

ORDER HERE

Single TESS™ 660 system with 1 headbox

SYSTEM DRAW (MM)	SYSTEM WIDTH (MM)		
	650-1000	1001-2000	2001-3000
<1500	£1,305.00	£1,413.80	£1,529.85
1501-3000	£1,404.95	£1,572.65	£1,733.15
3001-4500*	£1,504.90	£1,724.30	£1,936.40**

* larger headbox TESS™ 660L see datasheet

** horizontal installation: TESS™660L max. system width=2500mm

Twin system with 2 headboxes (one at each end)

SYSTEM DRAW (MM)	SYSTEM WIDTH (MM)		
	650-1000	1001-2000	2001-3000
4501-6000	£2,277.60	£2,565.15	£2,921.25
6001-9000*	£2,485.25	£2,876.30	£3,352.40**

* larger headbox TESS™ 660L see datasheet

** horizontal installation: TESS™660L max. system width=2500mm

Installation must be supervised by a trained installer to fulfil the product warranty.
See page 2 for details.

Quote

Q35602-58082



Customer: CP Interiors **Quote Date:** 21/10/2024 **Customer Ref.:** SO15245 Thomason
Contact Name: Tamara Lopez-Dominguez

System	Ref. No.	Finish & Width	Finish & Drop	Operation	Fabric Joins	Tube Dia.	Hem Bar	Hem Bar Colour	Hardware Colour	Fabric Type	Colour	Type	Shape	Channel/Bracket Type	Bottom Angle	Cust. Ref.	Notes	Unit RRP	Unit Price	Qty	Total	
KuroLok 125 RL	1	720	2850	Radio - RTS - Somfy Sonesse 40 9/12	0	75	Z	Black	Black	C Screen - 3m - BO	TBC	Cassette	Square	Channel	No	1	11	£2,420.55	£1,161.86	1	£1,161.86	
KuroLok 100	2	720	1010	Radio - RTS - Somfy Sonesse 40 6/20	0	65	Luxur y 46	Black	Black	C Screen - 3m - BO	TBC	Cassette	Square	Channel	No	2	2)	£886.74	£430.44	1	£430.44	
KuroLok 125 RL	3	1100	2800	Radio - RTS - Somfy Sonesse 40 9/12	0	75	Z	Black	Black	C Screen - 3m - BO	TBC	Cassette	Square	Channel	No	3	3)	£2,542.88	£1,220.58	1	£1,220.58	
KuroLok 80	4	1500	700	Radio - RTS - Somfy Sonesse 40 6/20	0	52	Luxur y 46	Black	Black	C Screen - 3m - BO	TBC	Cassette	Square	Channel	No	4	4)	£979.28	£470.05	1	£470.05	
KuroLok 100	5	1500	1800	Radio - RTS - Somfy Sonesse 40 6/20	0	65	Luxur y 46	Black	Black	C Screen - 3m - BO	TBC	Cassette	Square	Channel	No	5	5)	£1,132.05	£543.38	1	£543.38	
Blinds total																			5	£3,826.31		

Special Notes

Delivery Address

Your blinds are costed above, please see the last page for additional items

Spectrum Supply Va Umbra, 31 Yairad Road, Swansea West Business Park, Swansea, SA5 4BT
 Tel: 01792 562015 E-mail: sales@umbrashading.co.uk

The above sizes are blind sizes which will be used for manufacture
 The above pricing excludes VAT

Please note that the above pricing is based on this quotation being ordered in full on a single purchase order. Should you require these blinds in phases please discuss this with us as it may affect the pricing.

1) £2905 + 20
 2) £1096 + 20
 3) £3051 + 20
 4) £1175 + 20
 5) £1358 + 20

Remote £99

Quote

Q35602-58082



Customer: CP Interiors
Contact Name: Tamara Lopez-Dominguez

Order Date: 21/10/2024

Customer Ref.: SO15245 Thomason

Total Quantity: 6
Total Price: £3,879.22

Part No.	Details	Length	Unit RRP	Unit Price	Quantity	Total Price
1870420	Situo 5 RTS Pure II Multichannel Radio Control Handset		£123.94	£39.66	1	£39.66
	Standard Carriage		£13.25	£13.25	1	£13.25
Parts total:						£52.91
Blinds total:						£3,826.31
Grand total:						£3,879.22
Special Notes						
Spectrum Supply Ltd Umbra, 31 Ystrad Road, Swansea West Business Park, Swansea, SA5 4BT Tel: 01792 582015 E-mail: sales@umbrashading.co.uk						
The above sizes are blind sizes which will be used for manufacture The above pricing excludes VAT						
Delivery Address						

Please note that the above pricing is based on this quotation being ordered in full on a single purchase order. Should you require these blinds in phases please discuss this with us as it may affect the pricing.

Work Diary

Staff Name Adrian **Measurer or Fitter** Mr. Ben Thomason, Dell Farm, La Rue Du Bocage, St Brelade, JE3 8BP, **Customer Ref** Foreman Nathan 07825324126
Order No SO15245 **Measurer** 07829838787, ben.thomason@colliers.com **Date** 29-11-2023 **Time** 09:00

Notes: 0 To discuss options for blinds/shutters. Please get email address as well

Location	Supplier	Blind Type / Description	Colour	Qty	Width	Drop	Fitting Height	Blind/Recess	Controls	Brackets	Surface	Unit Price
MSTRK		Zip Screen	Blk									
bed		roller	TBA									
		Custom										
		Colour Hardware TBA possibly Blak						FRAC TBA				
		Sorry RFS										
		240 VFT										
		Nemote 4 chand										
1) slope window		All plus		1	800	2800		A Sloped				
2) slope	"	blind system		1	1100	2800		A Sloped				
Low	"	100 x 100 to top		1	1500	700		A				
Dormer	"	" - only		1	1500	1800		A				
		Plantation	Shdr	1	860	1000	+2 CR	A				
		Shutter										

Comments:

Order Date

Customer Signature
 I have checked and agree with the above choices
 Target Fitting Date

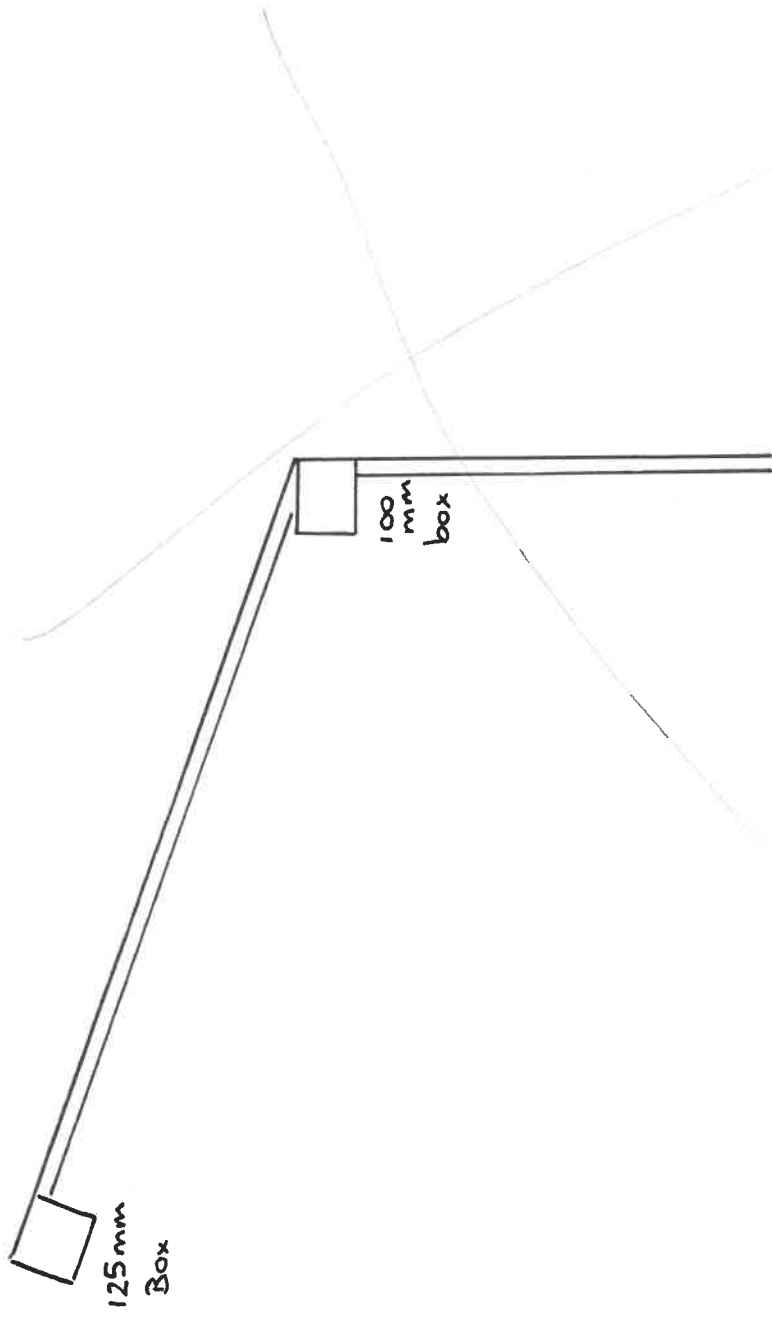

Tamara Lopez-Dominguez

From: Leighton Hill <leighton@umbrashading.co.uk>
Sent: 21 October 2024 13:42
To: Tamara Lopez-Dominguez
Subject: RE: Q35602 SO15245 Thomason
Attachments: Quote Q35602-58082.pdf; Roller Blind Characteristics.pdf; Umbra Product Brochure KuroLok.pdf; KuroLok RL Characteristics 2024.pdf; L-angle Length Guide for KuroLok RL 2.pdf; Umbra Product Brochure KuroLok RL.pdf; Top C-Screen Blackout Swatch.pdf

Hello Tamara,

Many thanks for your enquiry. Please see your quotation attached as requested.

For the ones that are on a slope, I have allowed for the KuroLok 125 RL system with black hardware, type Z hembar, C-Screen Blackout fabric, and Somfy Sonesse 40 RTS motors.

For the vertical ones, I have allowed for the KuroLok system with Luxury 46 hembar and same spec as above. A Multi-channel remote has been included.

I haven't included L-Angle fixing profiles for the rooflights, but if you need these, then let me know.

Kind regards,



Leighton Hill

Estimator

P. 01792 562015

E. leighton@umbrashading.co.uk W. www.umbrashading.co.uk

A. 31 Ystrad Road, Swansea, SA5 4BT

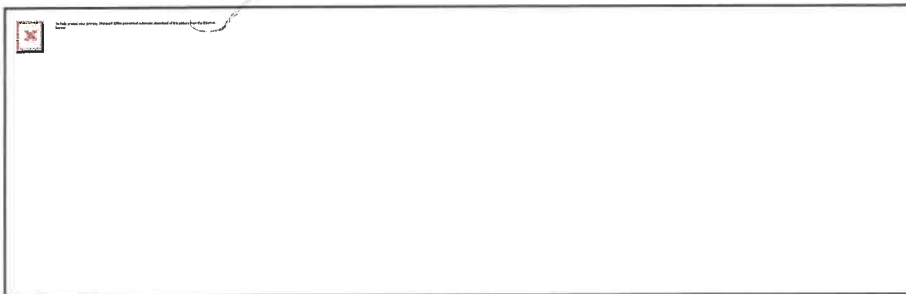

If you've received this by mistake, give me a shout, because somebody with a name very similar to yours will think I'm ignoring them. Only print it out if absolutely essential (like if there's a long checklist or something).

From: Tamara Lopez-Dominguez <Tamara@cpinteriors.je>
Sent: 21 October 2024 13:01
To: Leighton Hill <leighton@umbrashading.co.uk>
Subject: RE: SO15245 Thomason

Hi Leighton,



720mm wide x 2850mm to joint,

1010mm from joint to floor

①

2850

w. 720 plus tracks

127°

1010

Tracks For 8/0 roller
powder coated SLACK

②

2180

1020 plus tracks

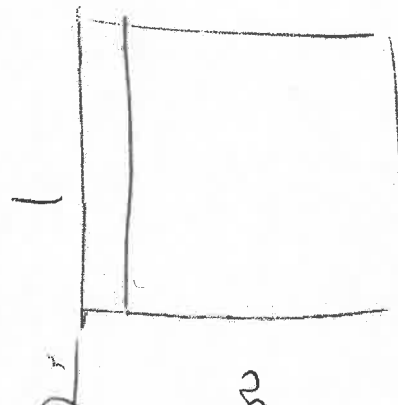
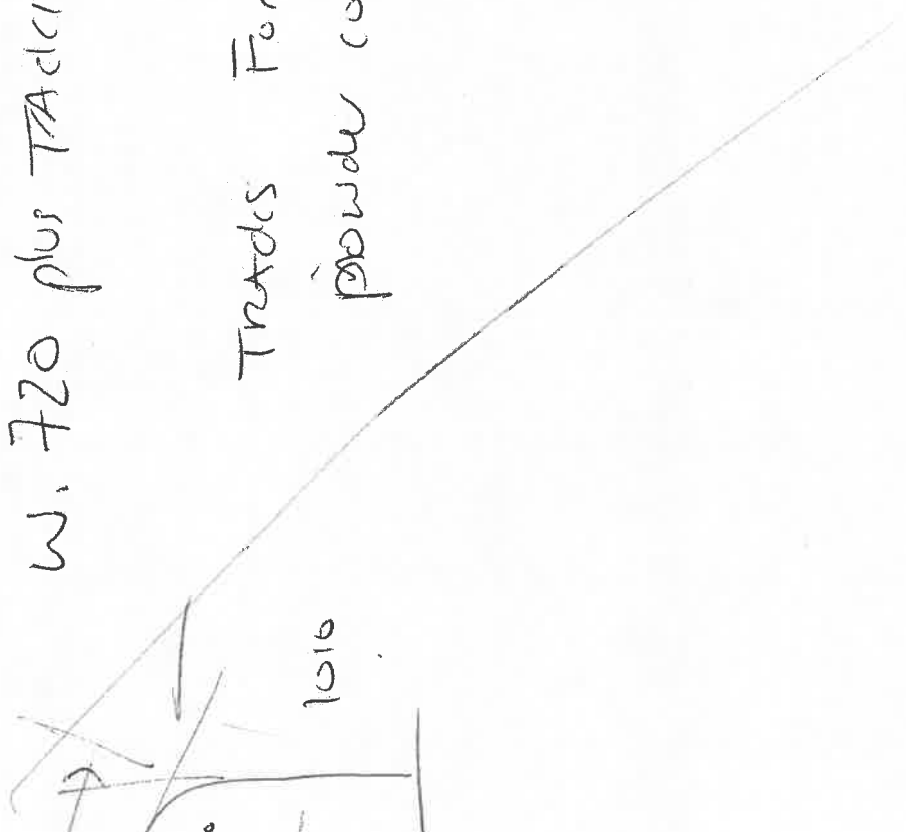



1100mm wide x 2800mm



1500mm x 7000mm

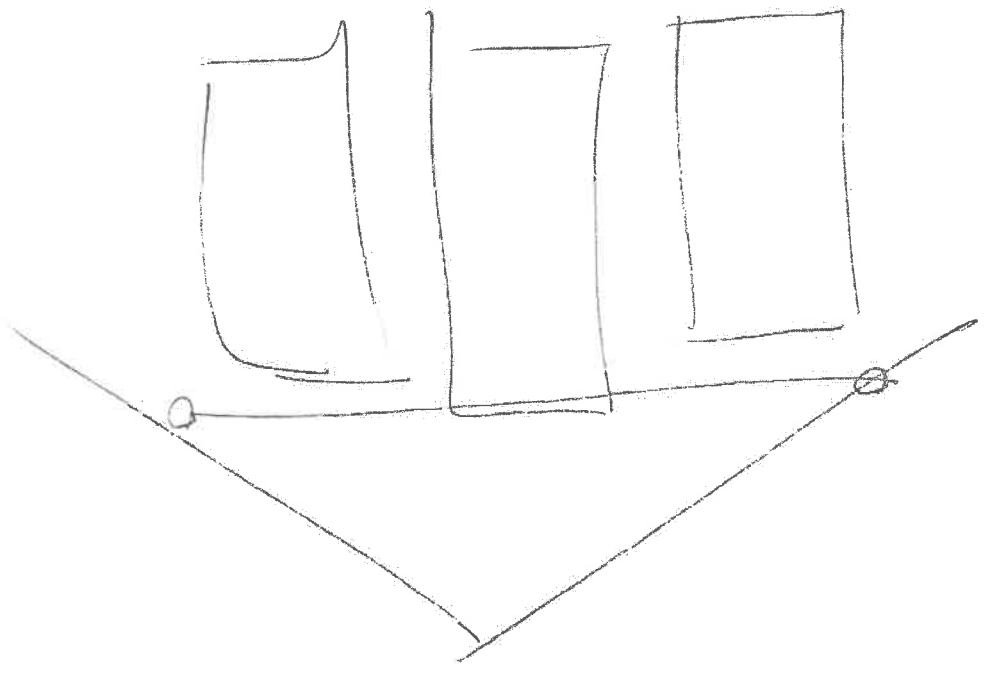

From: Tamara Lopez-Dominguez <Tamara@cpinteriors.je>
Sent: 11 October 2024 11:55
To: Leighton Hill <leighton@umbrashading.co.uk>
Subject: SO15245 Thomason

Hi Leighton,

I hope you are well.

Would you please be able to advise....

We have a client interested having possibly some Kurolok blackout rollers on the attached windows (maybe not on the tiny one), but ideally, they wouldn't want any boxes where the roof glass joins the side glass (pic 5). Is there anything you could offer?

If not, can you still prepare a quote for the Kurolok blackout rollers (with the boxes on that window too), with black hardware if that makes sense.

I have attached the sizes. Many thanks.

Kind Regards

Tamara
Lopez-Dominguez

Interior Design Advisor
tamara@cpinteriors.je



Unit 28 Rue Des Pres Trading Estate
St Saviour
Jersey
JE2 7QN
01534 768141 | www.cpinteriors.je
 



With our CP Price promise, we will beat any
** On like for like products only

Tamara
Lopez-Dominguez

Interior Design Advisor
tamara@cpinteriors.je



Unit 28 Rue Des Pres Trading Estate
St Saviour
Jersey
JE2 7QN

01534 768141 | www.cpinteriors.je



With our CP Price promise, we will beat any
** On like for like products only

From: Leighton Hill <leighton@umbrashading.co.uk>
Sent: 14 October 2024 09:24
To: Tamara Lopez-Dominguez <Tamara@cpinteriors.je>
Subject: RE: SO15245 Thomason

Hello Tamara,

Many thanks for your enquiry.

We don't have a solution for the sloping window I'm afraid. We would have to price for two separate blinds.

Can you please confirm which size is the window on Pic 5? It looks like the angle is over 30 degrees so the KuroLok RL system will have to be used.

Kind regards,

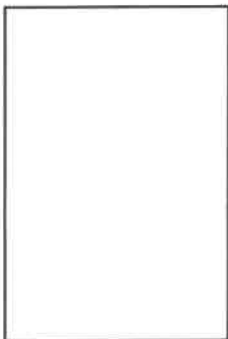

Leighton Hill

Estimator

P. 01792 562015

E. leighton@umbrashading.co.uk **W.** www.umbrashading.co.uk

A. 31 Ystrad Road, Swansea, SA5 4BT



If you've received this by mistake, give me a shout, because somebody with a name very similar to yours will think I'm ignoring them. Only print it out if absolutely essential (like if there's a long checklist or something).

From: Leighton Hill <leighton@umbrashading.co.uk>
Sent: 21 October 2024 12:15
To: Tamara Lopez-Dominguez <Tamara@cpinteriors.je>
Subject: RE: SO15245 Thomason

Hello Tamara,

Thanks for your email. Sorry to be a pain, but could you please email over the sizes that link with each pic?

Just trying to figure out which ones need to be on the rooflight system, and which ones need to be on the standard system.

Kind regards,

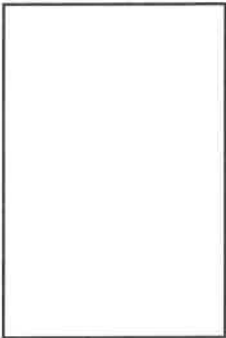

Leighton Hill

Estimator

P. 01792 562015

E. leighton@umbrashading.co.uk **W.** www.umbrashading.co.uk

A. 31 Ystrad Road, Swansea, SA5 4BT

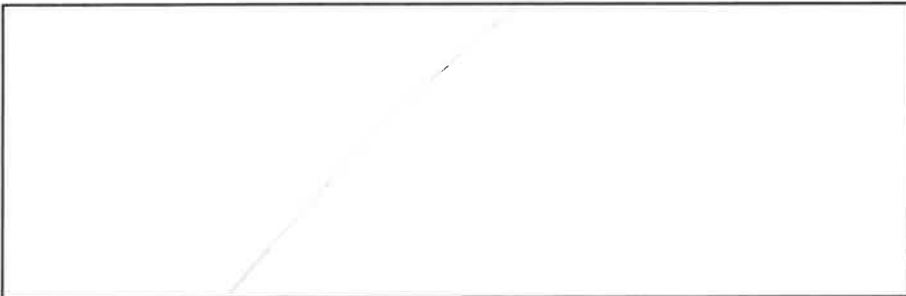

If you've received this by mistake, give me a shout, because somebody with a name very similar to yours will think I'm ignoring them. Only print it out if absolutely essential (like if there's a long checklist or something).

From: Tamara Lopez-Dominguez <Tamara@cpinteriors.je>
Sent: 18 October 2024 14:56
To: Leighton Hill <leighton@umbrashading.co.uk>
Subject: RE: SO15245 Thomason

Hi Leighton,

Apologies. It seems I had misplaced this email.

The window on Pic 5 is 720mm wide, the top part is 2850mm drop, the bottom part is 1010mm drop.

If you could please quote for the two separate blinds, that would be great. It is not what the client would like to have, but they might have no other option.

Many thanks.

Kind Regards



1500mm x 1800mm

Please let me know if you need any additional info.

Kind Regards

Tamara
Lopez-Dominguez

Interior Design Advisor
tamara@cpinteriors.je



Unit 28 Rue Des Pres Trading Estate
St Saviour
Jersey
JE2 7QN
01534 768141 | www.cpinteriors.je
 



With our CP Price promise, we will beat any
** On like for like products only

Mr. Ben Thomason

Dell Farm
La Rue Du Bocage
St Brelade
JE3 8BP

Date	Reference	Your Contact
11-03-2024	SO15263	Tamara

Customer Ref.

Blindspace boxing only for W3

Quote

Our Price Promise to you
We are so confident our pricing is competitive, that we will beat any written quotation for equivalent product by 5%

~~Supply & Fit~~ Supply Only

Location	Description	QTY	Price
Master Bedroom W3	Recess Boxing / Profiles, 1.5m of Blindspace Reese <i>curtain track recess</i> standard headbox profile. Includes 2 endcaps. <i>for manual curtain track.</i>	1	£ 138.95

Terms : Payment with Order

BACS Payment Bank: NatWest Sort Code: 60 12 03 Account No: 66577772 Carpet Protection (C.I) Ltd T/A CP Interiors		Phone and Card Payment Payment can be made in person or by phone. If phone, please call us on 01534 768141 and have your card details ready. Note, we do not accept American Express or Cheque payments.	Subtotal : £ 138.95 GST : £ 6.95 Total : £ 145.90
---	--	--	--

Please note: This quotation is only valid for acceptance for 14 days. Our estimate does not include any electrical work or additional carpentry work to install the above unless otherwise specified. Please note there is a handling charge on customer own fabric of £7.50 per metre. Due to high costs of labour, pre-arranged missed fitting appointments will be charged on a time-wasted basis. Settlement is due on completion of works and an administration charge of £25 will be added per month if unpaid within 30 days. We reserve the right to charge for design, advice and liaison work carried out should an order not be placed. Goods remain the property of CP Interiors until full settlement is received. Should payment not be received we reserve the right to attend premises during working hours to remove goods and not be required to make good. Our full terms and conditions apply and are available on request.

Work Diary

Staff Name: Adrian
 Order No: SO15245
 Measurer or Fitter: Measurer

Contact Address: Mr. Ben Thomason, Dell Farm, La Rue Du Bocage, St Briade, JE3 8BP,
 07825324126, 07829838787, ben.thomason@colliers.com

Customer Ref: Blinds and shutter

Date: 01-03-2024
 Time: 15:00

Primitive Linen Garlic PR1M2
 140cm @ £150p/m

Notes: To go through quote with client as they want to finalise and order

Sparez de la Cour

Location	Supplier	Blind Type /Description	Colour	Qty	Width	Drop	Fitting Height	Blind/Recess	Controls	Brackets	Surface	Unit Price
		Single Curtain	Blk	1	1800	1200			RHS	FATH		
		or Venetian	u		T/W	F/D	*					
	Single Rope	Swarm	Split Trade									
		Pair	u	1	2900	2350	#					
					T/W	F/D						
	Single Stage	Single Curtain		1	1400	2150			RHS	TOP		
		in Reuse			T/W	F/D						
		sample → RTIF	1.5m @ £66.71 + 20% = £120.067									£138.95
			FC35F 2x		£18.87	£18.87						
		(10 Room for	Blind spare									
		Box)										
		Zip, RTIF		2	AS	over						

* HANG WITH 15mm on floor

Comments:

Order Date: _____

Customer Signature: _____

I have checked and agree with the above choices

Target Fitting Date: _____

~~NOT INTERESTED~~



CP INTERIORS

Ben Thomason

Dell Farm
La Rue Du Bocage
St Brelade
JE3 8BP

Date	Reference	Your Contact
07-12-2023	SO15263	Tamara

Customer Ref.
Blindspace boxing

Quote

Our Price Promise to you
We are so confident our pricing is competitive, that we will beat any written quotation for equivalent product by 5%

Supply & Fit/Supply Only

Location	Description	QTY	Price
Master Bedroom	Supply only- Recess Boxing / Profiles, 6m of Blindspace Standard S Series head box profile. Includes 8 endcaps, Subject to final measurements, <i>100x100</i>	1	£ 1,244.76

Terms : 50% deposit due with order, 50% on completion

BACS Payment	
Bank:	NatWest
Sort Code:	60 12 03
Account No:	66577772
Carpet Protection (C.I) Ltd T/A CP Interiors	

Phone and Card Payment
Payment can be made in person or by phone. If phone, please call us on 01534 768141 and have your card details ready. Note, we do not accept American Express or Cheque payments.

Subtotal :	£ 1,244.76
GST :	£ 62.24
Total :	£ 1,307.00

Please note: This quotation is only valid for acceptance for 14 days. Our estimate does not include any electrical work or additional carpentry work to install the above unless otherwise specified. Please note there is a handling charge on customer own fabric of £7.50 per metre. Due to high costs of labour, pre-arranged missed fitting appointments will be charged on a time-wasted basis. Settlement is due on completion of works and an administration charge of £25 will be added per month if unpaid within 30 days. We reserve the right to charge for design, advice and liaison work carried out should an order not be placed. Goods remain the property of CP Interiors until full settlement is received. Should payment not be received we reserve the right to attend premises during working hours to remove goods and not be required to make good. Our full terms and conditions apply and are available on request.

