



CP INTERIORS

QUOTE

To: Miguel Garcia
 27 West Park Apartments
 La Route De St Aubin
 St Helier
 JE2 3PZ

Job Number: SO16603 Q4

Quote Date: Thursday 03 Apr 2025

Customer Reference:

Deposit required: £ 2,510.03

Awning *SPRING OFFER*

Your Contact: Tamara

Our Price Promise to you

We are so confident our pricing is competitive, that we will beat any written quotation for equivalent product by 5%

To supply and fit unless otherwise stated.

Location	Product	Description	Qty	Price
----------	---------	-------------	-----	-------

OPTION 4 - Cassita II Spring Campaign 4.6m x 2.4m

	Awning / Canopy	Weinor Spring Campaign Cassita II electrically operated awning with full cassette and vibration sensor, powder coated in WT029/10797 Approx. RAL 9010, in WE3-515 Alabaster. Left - hand side motor. Size 4.6m wide x 2.4m projection. Includes remote.	1	£ 4,481.00
--	------------------------	---	---	------------



Spring offer only valid for Cassita II and Smaila awnings on orders placed with the supplier by the 15th of May.

This offer includes:

- Free remote control motor receiver or motor upgrade
- Free remote radio handset
- Free vibration sensor

With a total saving of £1,033

	Accessories	Hiring of a crane for access with the awning <i>Al Sun</i>	1	£ 300.00
--	--------------------	--	---	----------

see above

As previously discussed, we strongly recommend discussing the type of awning with the building's manager to seek approval as this type of awning is different from the other ones installed by CP Interiors in the same building

Electrical works not included

Terms: 50% deposit due with order, 50% on completion

**** To go ahead with this quote please make deposit payment. To pay by card call us on 01534 768141 ****

Direct Deposit - Sort Code: 60-12-03 Account: 66577772

If you have any queries please call us on 01534 768141 or visit our showroom Rue des Pres Trading Estate St Saviour

** For Our Terms & Conditions of Sale please go to www.cpinteriors.je **

Subtotal £ 4,781.00

GST £ 239.05

Total £ 5,020.05

Paid amount £ 0.00

Total amount £ 5,020.05

Please note: This quotation is only valid for acceptance for 7 days. Our estimate does not include any electrical work or additional carpentry work to install the above unless otherwise specified. Please note there is a handling charge on customer own fabric of £7.50 per metre. Due to high costs of labour, pre-arranged missed fitting appointments will be charged on a time-wasted basis. Settlement is due on completion of works and an administration charge of £25 will be added per month if unpaid within 30 days. We reserve the right to charge for design, advice and liaison work carried out should an order not be placed. Goods remain the property of CP Interiors until full settlement is received. Should payment not be received we reserve the right to attend premises during working hours to remove goods and not be required to make good. Our full terms and conditions apply and are available on request.

weinor Ltd 73 Cornhill EC3V 3QQ London

C P Interiors

**Rue Des Pres Trading Estate
GB-JE2 7QN St Saviour Jersey**

delivery address

DSV Road Ltd
(NO UPS)
10 Brunel Way, Segensworth Industrial Estate
GB-PO15 5TX Hampshire, Fareham
NO UPS

ORDER CONFIRMATION (release 1)

sales order no.: 202894807 of 03.04.2025
customer: 165708
reference: García Cassita
Your order no.: SO16603 ~~024~~
contact person: William Abbott
E-Mail: WAbbott@weinor.de
phone number: +49-221-59709-472
representat. 654 Chris Spickett
tel (representat.): 0044 (0) 7894443907

pos	quantity	article code
-----	----------	--------------

2	1,00	1308	Cassita II spring campaign
---	------	------	----------------------------

Scheduling delivery	:	Please contact your person in charge for planning the expected date of delivery.	
Product use	:	private flat	
width (cm)	:	460	cm
Projection [cm]	:	240	cm 2.927,00
Base colour	:	WT029/10797 Approx. RAL 9010	
no. of arms	:	2	Piece
Control type	:	getoptionbezeichnung()	
insulation [mm]	:	0	mm
bracket type 1	:	wall fixing	
number of brackets 1	:	2	Piece 60,00

weinor Ltd
73 Cornhill
GB-EC3V 3QQ London
weinor.com

Managing Director:
Tim Földner
General partner:
Weinor Beteiligungs-GmbH
Köln

VAT no.: 335 2381 16
Company no.: 12193066
UTR no.: 33431 24084
EORI no.: GB335238116000

Domestic transfers:
Commerzbank London
Sort Code: 406201
Account Number: 307 537 10

International transfers:
Commerzbank London
IBAN: GB51 COBA 4062 0130 7537 10
Swift: MIDLGB22 a/c COBAGB2X

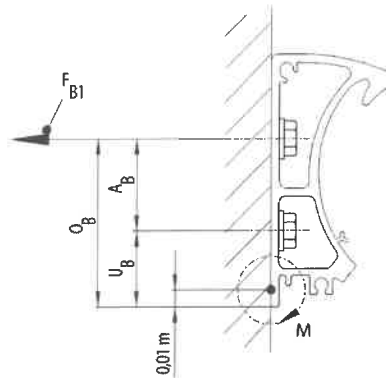

Force 1 means the pull-out force per upper fastener F(B).

FB1 Force 1 per fixing point	: 1954	N
Torque per folding arm [Nm]	: 352	Nm

Please note that your selected awning configuration results in the following forces per upper fixing point (pull-out, lateral and/or shear forces). These must be accounted for by using suitable fixings.

bracket position left [mm]	: 90	mm
bracket position right [mm]	: 90	mm
arm position left	: 58	mm
arm position right	: 58	mm
type of control	: Remote-controlled motor IO Homecontrol	
Side of control (seen from the front)	: left	
control	: hand transmitter Situo 5 io II by weinor	
type of motor	: Motor Sfy Sunea50 io 40/17 ohne Zubehör	
Somfy radio wind sensor io	: with Somfy Eolis 3D WireFree io; white housing	
real-design	: WE3-515	alabaster, my collections 2
Glue fabric?	: no, sewn fabric	
colour of thread Saba	: white	
Cardboard packaging	: edges reinforcement	
weight	: 59	kg

pos	quantity	article code			
	value of goods	discount amount / %	net		
	2.987,00	1.194,80 / 40,00	1.792,20		
	value of goods	discount amount	net	VAT (0 %)	Total GBP
	2.987,00	1.194,80	1.792,20	0,00	1.792,20

Our spoken and written advice focuses on an explanation of the best possible use of our products and services. It does not liberate you from the obligation to check fitness of our products and services for your particular purpose. That includes the inspection of the general condition and especially maximum capacity load of fixing base as well as forwarding all respective information in addition to your order to weinor. That way delivery of the correct type and number of brackets is guaranteed. If our product can not be used as upon agreement due to false or lacking information we or any auxiliary person do accept contractual or non-contractual liabilities only in case of malicious intent or gross negligence.

In order to mount all brackets corresponding their fixing base you will need suitable mounting systems. For mounting on concrete C20/25 we recommend heavy duty anchor-systems from fischer (e.g. FAZ II M12/10 GS or FAZ II M12/30 GS). In case of mounting on any other base referred to in our pricelist or on frontal concrete ceiling we recommend the use of injection systems from fischer (e.g. FIS V 360 S). You can order them directly from us.

If you use a different mounting system or your own brackets, you will need a table of pull-out resistance of screw anchors in order to determine the working load.

In addition, our General Terms of Delivery and Payment as per 01/2024, published under the link provided below are valid and we are happy to provide you with them free of charge upon request.

<https://www.weinor.com/terms-and-conditions/>

delivery exw Cologne
 payment: With direct debit 5% discount payment
 mode of dispatch UK export

Configuration details

weinor Ltd 73 Cornhill EC3V 3QQ London

C P Interiors

Rue Des Pres Trading Estate
GB-JE2 7QN St Saviour Jersey

reference: Garcia Cassita
Your order no.: SO16603 Q2 *14*
weinor customernumber: 165708
creation Date: 03.04.2025
weinor pers. in charge: William Abbott
phone / fax number: +49-221-59709-472
representat.: Chris Spickett
tel (representat.): 0044 (0) 7894443907

pos	quantity	article	price
2	1	weinor Cassita II spring campaign	2.987,00

Scheduling delivery	: Please contact your person in charge for planning the expected date of delivery.	
Product use	: private flat	
width (cm)	: 460 cm	
Projection [cm]	: 240 cm	2.927,00
Base colour	: WT029/10797 Approx. RAL 9010	
no. of arms	: 2 Piece	
Control type	: Somfy io control including Situo io Pure handset and Sunea io motor upgrade	
insulation [mm]	: 0 mm	
bracket type 1	: wall fixing	
number of brackets 1	: 2 Piece	60,00
FB1 Force 1 per fixing point	: 1954 N	
Torque per folding arm [Nm]	: 352 Nm	
bracket position left [mm]	: 90 mm	
bracket position right [mm]	: 90 mm	
arm position left	: 58 mm	
arm position right	: 58 mm	
type of control	: Remote-controlled motor IO Homecontrol	
Side of control (seen from the front)	: left	
control	: hand transmitter Situo 5 io II by weinor - <i>1 channel Remote</i>	
type of motor	: Motor Sfy Sunea50 io 40/17 ohne Zubehör	
Somfy radio wind sensor io	: with Somfy Eolis 3D WireFree io; white housing	
real-design	: WE3-515	
Glue fabric?	: no, sewn fabric	

RB checked ✓

weinor Ltd
73 Cornhill
GB-EC3V 3QQ London
weinor.com

Managing Director:
Tim Fuldner
General partner:
Weinor Beteiligungs-GmbH
Köln

VAT no.: 335 2381 16
Company no.: 12193066
UTR no.: 33431 24084
EORI no.: GB335238116000

Domestic transfers:
Commerzbank London
Sort Code: 406201
Account Number: 307 537 10

International transfers:
Commerzbank London
IBAN: GB51 COBA 4062 0130 7537 10
Swift: MIDLGB22 a/c COBAGB2X

Configuration details

weinor Ltd 73 Cornhill EC3V3QQ London

customer: 165708 reference: García Cassita Page 2 of 2

pos	quantity	article	price
		colour of thread Saba : white	
		Cardboard packaging : edges reinforcement	
		weight : 59 kg	

value of goods	discount amount / %	net
2.987,00	1.194,80 / 40,00	1.792,20

value of goods GBP	discount amount	net GBP	VAT (0 %)	Total GBP
2.987,00	1.194,80	1.792,20	0,00	1.792,20

Work Diary

Staff Name Ben **Surveyor** Measurer **Contact Address** Mr. Miguel, Garcia27 West Park Apartments, La Route De St Aubin, St Helier, JE2 3PZ, 07797840428, angelmikele@gmail.com **Customer Ref** Awning **Date** 02-04-2025 **Time** AM
Order No SO16603 **Measurer** **Mr. Miguel, Garcia27 West Park Apartments, La Route De St Aubin, St Helier, JE2 3PZ, 07797840428, angelmikele@gmail.com**

Notes : To measure for awning (quoted as Cassita). Client's wife (Nina) will be at home 07700720383. Client have been told to check with building manager regarding different type of awning. Please advise regarding crane as well

Location	Supplier	Blind Type /Description	Colour	Qty	Width	Drop	Fitting Height	B or R	Controls	Brackets	Surface	Unit Price
Bekon	4th Floor	Cassita			5500	2400			LHM			
					4600							
		WT029 / 10997										
		Approx RAL 9010										
		Fabric w€3-515										
		White/Alabaster										

Comments: Same hardware colour and fabric as Trevor Rooke's awning and Apartment 18
 Quote both sizes
 client will let us know

Surface Fixing
 C=Concrete
 W=Wood
 M=Metal
 B=Brick
 P=Plastic
 T=Tile

Order
 Quote

Customer Signature
 I have checked and agree with the above choices
Target Fitting Date



CP INTERIORS

QUOTE

To:
Miguel Garcia
27 West Park Apartments
La Route De St Aubin
St Helier
JE2 3PZ

Job Number: SO16603 Q1
Customer Reference:
Awning

Quote Date: Thursday 03 Apr 2025
Deposit required: £ 3,415.65
Your Contact: Tamara

Our Price Promise to you
We are so confident our pricing is competitive, that we will beat any written quotation for equivalent product by 5%

To supply and fit unless otherwise stated.

Location	Product	Description	Qty	Price
		OPTION 1 - Opal Design II 5.5m x 2.4m		
	Awning / Canopy	Weinor Opal Design II electrically operated awning with full cassette and vibration sensor, powder coated in WT029/10797 Approx. RAL 9010, in WE3-515 Alabaster. Left-hand side motor. Size 5.5m wide x 2.4m projection. Includes remote.	1	£ 6,206.00

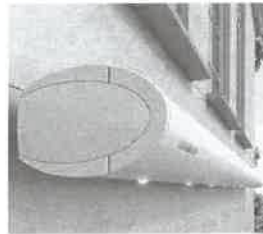

	Accessories	Hiring of a crane for access with the awning <i>Ac Sun</i>	1	£ 300.00
--	--------------------	--	---	----------

Awning with same specifications as those installed by CP Interiors in the same building

Electrical works not included

Please note the photo is only for reference. This quote is based on the option without the LED lights

Terms: 50% deposit due with order, 50% on completion

**** To go ahead with this quote please make deposit payment. To pay by card call us on 01534 768141 ****

Direct Deposit - Sort Code: 60-12-03 Account: 66577772

If you have any queries please call us on 01534 768141 or visit our showroom Rue des Pres Trading Estate St Saviour

** For Our Terms & Conditions of Sale please go to www.cpinteriors.je **

Subtotal	£ 6,506.00
GST	£ 325.30
Total	£ 6,831.30
Paid amount	£ 0.00
Total amount	£ 6,831.30

Please note: This quotation is only valid for acceptance for 7 days. Our estimate does not include any electrical work or additional carpentry work to install the above unless otherwise specified. Please note there is a handling charge on customer own fabric of £7.50 per metre. Due to high costs of labour, pre-arranged missed fitting appointments will be charged on a time-wasted basis. Settlement is due on completion of works and an administration charge of £25 will be added per month if unpaid within 30 days. We reserve the right to charge for design, advice and liaison work carried out should an order not be placed. Goods remain the property of CP Interiors until full settlement is received. Should payment not be received we reserve the right to attend premises during working hours to remove goods and not be required to make good. Our full terms and conditions apply and are available on request.



CP INTERIORS

QUOTE

To:
 Miguel Garcia
 27 West Park Apartments
 La Route De St Aubin
 St Helier
 JE2 3PZ

Job Number: SO16603 Q2

Quote Date: Thursday 03 Apr 2025

Customer Reference:

Deposit required: £ 2,628.15

Awning
SPRING OFFER

Your Contact: Tamara

Our Price Promise to you

We are so confident our pricing is competitive, that we will beat any written quotation for equivalent product by 5%

To supply and fit unless otherwise stated.

Location	Product	Description	Qty	Price
----------	---------	-------------	-----	-------

OPTION 2 - Cassita II Spring Campaign 5.5m x 2.4m

Awning / Canopy

Weinor Spring Campaign Cassita II electrically operated awning with full cassette and vibration sensor, powder coated in WT029/10797 Approx. RAL 9010, in WE3-515 Alabaster. Left - hand side motor.
 Size 4.6m wide x 2.4m projection.
 Includes remote.

1

£ 4,706.00

5.5m →

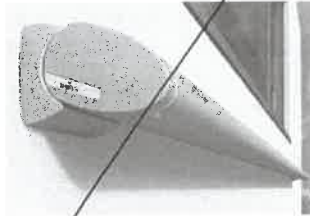

Spring offer only valid for Cassita II and Smaila awnings on orders placed with the supplier by the 15th of May.

This offer includes:

- Free remote control motor receiver or motor upgrade
 - Free remote radio handset
 - Free vibration sensor
- With a total saving of £1,033

Accessories

Hiring of a crane for access with the awning = P.C. Sum

1

£ 300.00

*As previously discussed, we strongly recommend discussing the type of awning with the building's manager to seek approval as this type of awning is different from the other ones installed by CP Interiors in the same building. *This is*

Electrical works not included

Please note this model is different to others installed on your building, we advise you please ensure you have the necessary approvals.

Terms: 50% deposit due with order, 50% on completion

**** To go ahead with this quote please make deposit payment. To pay by card call us on 01534 768141 ****

Direct Deposit - Sort Code: 60-12-03 Account: 66577772

If you have any queries please call us on 01534 768141 or visit our showroom Rue des Pres Trading Estate St Saviour

Subtotal £ 5,006.00

GST £ 250.30

Total £ 5,256.30

Paid amount £ 0.00

Total amount £ 5,256.30

**** For Our Terms & Conditions of Sale please go to www.cpinteriors.je ****

Please note: This quotation is only valid for acceptance for 7 days. Our estimate does not include any electrical work or additional carpentry work to install the above unless otherwise specified. Please note there is a handling charge on customer own fabric of £7.50 per metre. Due to high costs of labour, pre-arranged missed fitting appointments will be charged on a time-wasted basis. Settlement is due on completion of works and an administration charge of £25 will be added per month if unpaid within 30 days. We reserve the right to charge for design, advice and liaison work carried out should an order not be placed. Goods remain the property of CP Interiors until full settlement is received. Should payment not be received we reserve the right to attend premises during working hours to remove goods and not be required to make good. Our full terms and conditions apply and are available on request.



CP INTERIORS

QUOTE

To:
Miguel Garcia
27 West Park Apartments
La Route De St Aubin
St Helier
JE2 3PZ

Job Number: SO16603 Q3
Customer Reference:
Awning

Quote Date: Thursday 03 Apr 2025
Deposit required: £ 3,266.03
Your Contact: Tamara

Our Price Promise to you
We are so confident our pricing is competitive, that we will beat any written quotation for equivalent product by 5%

To supply and fit unless otherwise stated.

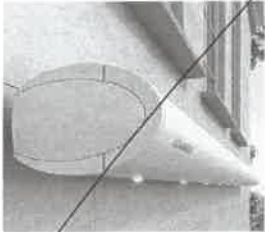
Location	Product	Description	Qty	Price
		OPTION 3 - Opal Design II 4.6m x 2.4m		
	Awning / Canopy	Weinor Opal Design II electrically operated awning with full cassette and vibration sensor, powder coated in WT029/10797 Approx. RAL 9010, in oWE3-515 Alabaster. Left-hand side motor. Size 4.6m wide x 2.4m projection. Includes remote.	1	£ 5,921.00
				
	Accessories	Hiring of a crane for access with the awning <i>Re Sean</i>	1	£ 300.00
		Awning with same specifications as those installed by CP Interiors in the same building		
		Electrical works not included		
		Please note the photo is only for reference. This quote is based on the option without the LED lights		

Terms: 50% deposit due with order, 50% on completion

**** To go ahead with this quote please make deposit payment. To pay by card call us on 01534 768141 ****

Direct Deposit - Sort Code: 60-12-03 Account: 66577772

If you have any queries please call us on 01534 768141 or visit our showroom Rue des Pres Trading Estate St Saviour

**** For Our Terms & Conditions of Sale please go to www.cpinteriors.je ****

Subtotal	£ 6,221.00
GST	£ 311.05
Total	£ 6,532.05
Paid amount	£ 0.00
Total amount	£ 6,532.05

Please note: This quotation is only valid for acceptance for 7 days. Our estimate does not include any electrical work or additional carpentry work to install the above unless otherwise specified. Please note there is a handling charge on customer own fabric of £7.50 per metre. Due to high costs of labour, pre-arranged missed fitting appointments will be charged on a time-wasted basis. Settlement is due on completion of works and an administration charge of £25 will be added per month if unpaid within 30 days. We reserve the right to charge for design, advice and liaison work carried out should an order not be placed. Goods remain the property of CP Interiors until full settlement is received. Should payment not be received we reserve the right to attend premises during working hours to remove goods and not be required to make good. Our full terms and conditions apply and are available on request.



CP INTERIORS

QUOTE

To:
Miguel Garcia
27 West Park Apartments
La Route De St Aubin
St Helier
JE2 3PZ

Job Number: SO16603 Q2
Customer Reference:
Option 2 - Cassita II Spring Campaign

Quote Date: Tuesday 01 Apr 2025
Deposit required: £ 2,456.48
Your Contact: Tamara

Our Price Promise to you
We are so confident our pricing is competitive that we will beat any written quotation for equivalent product by 5%

To supply and fit unless otherwise stated.

Location	Product	Description	Qty	Price
		Option 2 - Cassita II Spring Campaign		
	Awning / Canopy	Weinor Spring Campaign Cassita II electrically operated awning with full cassette and vibration sensor, powder coated in one of the standard colours, in one of the My Collection fabrics available. Motor side TBC. Size 5m wide x 3m projection. Includes remote.	1	£ 4,679.00

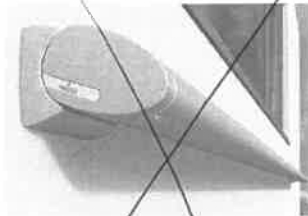

Spring offer only valid for Cassita II and Smaila awnings on orders placed with the supplier by the 15th of May.

This offer includes:
- Free remote control motor receiver or motor upgrade
- Free remote radio handset
- Free vibration sensor
With a total saving of £1,033

Electrical works not included

Subject to final measurements. Please be aware a crane will be needed. We estimate that the cost for the crane will be approximately £300, but it is to be confirmed once we have carried out the site survey

Terms: 50% deposit due with order, 50% on completion

**** To go ahead with this quote please make deposit payment. To pay by card call us on 01534 768141 ****

Direct Deposit - Sort Code: 60-12-03 Account: 66577772

If you have any queries please call us on 01534 768141 or visit our showroom Rue des Pres Trading Estate St Saviour

** For Our Terms & Conditions of Sale please go to www.cpiinteriors.je **

Subtotal	£ 4,679.00
GST	£ 233.95
Total	£ 4,912.95
Paid amount	£ 0.00
Total amount	£ 4,912.95



Please note: This quotation is only valid for acceptance for 7 days. Our estimate does not include any electrical work or additional carpentry work to install the above unless otherwise specified. Please note there is a handling charge on customer own fabric of £7.50 per metre. Due to high costs of labour, pre-arranged missed fitting appointments will be charged on a time-wasted basis. Settlement is due on completion of works and an administration charge of £25 will be added per month if unpaid within 30 days. We reserve the right to charge for design, advice and liaison work carried out should an order not be placed. Goods remain the property of CP Interiors until full settlement is received. Should payment not be received we reserve the right to attend premises during working hours to remove goods and not be required to make good. Our full terms and conditions apply and are available on request.

Configuration details

weinor Ltd 73 Cornhill EC3V 3QQ London

C P Interiors

**Rue Des Pres Trading Estate
GB-JE2 7QN St Saviour Jersey**

reference: García Cassita
Your order no.: SO16603 Q2
weinor customernumber: 165708
creation Date: 01.04.2025
weinor pers. in charge: William Abbott
phone / fax number: +49-221-59709-472
representat.: Chris Spickett
tel (representat.): 0044 (0) 7894443907

pos	quantity	article	price
1	1	weinor Cassifa II spring campaign	3.119,00
		Scheduling delivery : Please contact your person in charge for planning the expected date of delivery.	
		Product use : private flat	
		width (cm) : 500 cm	
		Projection [cm] : 300 cm	3.059,00
		Base colour : WT029/90147 Approx. RAL 9007 Metallic	
		no. of arms : 2 Piece	
		Control type : Somfy io control including Situo io Pure handset and Sunea io motor upgrade	
		insulation [mm] : 0 mm	
		bracket type 1 : wall fixing	
		number of brackets 1 : 2 Piece	60,00
		FB1 Force 1 per fixing point : 3101 N	
		Torque per folding arm [Nm] : 558 Nm	
		bracket position left [mm] : 90 mm	
		bracket position right [mm] : 90 mm	
		arm position left : 58 mm	
		arm position right : 58 mm	
		type of control : Remote-controlled motor IO Homecontrol	
		Side of control (seen from the front) : left	
		control : hand transmitter Situo 5 io II by weinor	
		type of motor : Motor Sfy Sunea50 io 40/17 ohne Zubehör	
		Somfy radio wind sensor io : with Somfy Eolis 3D WireFree io; black housing	
		real-design : WE3-509	
		Glue fabric? : no, sewn fabric	

weinor Ltd
73 Cornhill
GB-EC3V 3QQ London
weinor.com

Managing Director:
Tim Földner
General partner:
Weinor Beteiligungs-GmbH
Köln

VAT no.: 335 2381 16
Company no.: 12193066
UTR no.: 33431 24084
EORI no.: GB335238116000

Domestic transfers:
Commerzbank London
Sort Code: 406201
Account Number: 307 537 10

International transfers:
Commerzbank London
IBAN: GB51 COBA 4062 0130 7537 10
Swift: MIDLGB22 a/c COBAGB2X

Configuration details

weinor Ltd 73 Cornhill EC3V 3QQ London

customer: 165708 reference: García Cassita Page 2 of 3

pos	quantity	article	price
		colour of thread Saba	: RAL 7001 Silver grey
		Cardboard packaging	: edges reinforcement
		weight	: 65 kg

	value of goods	discount amount / %	net
	3.119,00	1.247,60 / 40,00	1.871,40

£4,679
Spring offer

Configuration details

weinor Ltd 73 Cornhill EC3V 3QQ London

customer: 165708 reference: García Cassita Page 3 of 3
 pos quantity article price

2 1 weinor Cassita II **NORMAL PRICE** 3.532,00

Scheduling delivery : Please contact your person in charge for planning the expected date of delivery.

Product use : private flat

width (cm) : 500 cm

Projection [cm] : 300 cm 3.059,00

Base colour : WT029/90147 Approx. RAL 9007 Metallic

no. of arms : 2 Piece

insulation [mm] : 0 mm

bracket type 1 : wall fixing

number of brackets 1 : 2 Piece 60,00

FB1 Force 1 per fixing point : 3101 N

Torque per folding arm [Nm] : 558 Nm

bracket position left [mm] : 90 mm

bracket position right [mm] : 90 mm

arm position left : 58 mm

arm position right : 58 mm

type of control : Remote-controlled motor IO Homecontrol 139,00

Side of control (seen from the front) : left

Hirschmann plug? : without Hirschmann plug

control : hand transmitter Situo 1 io II by weinor 73,00

type of motor : Motor Sfy Suna50 io 40/17 ohne Zubehör

Somfy radio wind sensor io : with Somfy Eolis 3D WireFree io; black housing (x2.5 = £1033) 201,00

real-design : WE3-509

colour of thread Saba : RAL 7001 Silver grey

Cardboard packaging : edges reinforcement

weight : 65 kg

value of goods	discount amount / %	net
3.532,00	1.412,80 / 40,00	2.119,20
	<i>NORMAL</i>	<i>£5,298</i>

value of goods GBP	discount amount	net GBP	VAT (0 %)	Total GBP
6.651,00	2.660,40	3.990,60	0,00	3.990,60



CP INTERIORS

QUOTE

To:
 Miguel Garcia
 27 West Park Apartments
 La Route De St Aubin
 St Helier
 JE2 3PZ

Job Number: SO16603 Q1
Customer Reference:
 Awning

Quote Date: Wednesday 19 Mar 2025
Deposit required: £ 3,376.28
Your Contact: Tamara

Our Price Promise to you
 We are so confident our pricing is competitive, that we will beat any written quotation for equivalent product by 5%

To supply and fit unless otherwise stated.

Location	Product	Description	Qty	Price
	Awning / Canopy	Weinor Opal Design II electrically operated awning with full cassette and vibration sensor, powder coated in one of the standard colours, in one of the My Collection fabrics available. Motor side TBC. Size 5m wide x 3m projection. Includes remote.	1	£ 6,431.00

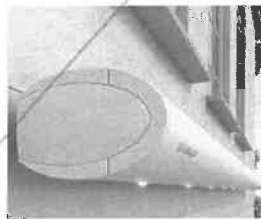

Sent but wants options for other awnings + gate for crane.

Awning as per existing one installed by CP Interiors at 28 West Park Apartments

Electrical works not included

Subject to final measurements. Please be aware that in order to install the awning a crane will most likely be needed. This cost will be confirmed once we have carried out a site survey

****Please note the photo is only for reference. This quote is based on the option without the LED lights****

Terms: 50% deposit due with order, 50% on completion

**** To go ahead with this quote please make deposit payment. To pay by card call us on 01534 768141 ****

Direct Deposit - Sort Code: 60-12-03 Account: 66577772

If you have any queries please call us on 01534 768141 or visit our showroom Rue des Pres Trading Estate St Saviour

** For Our Terms & Conditions of Sale please go to www.cpinteriors.je **

Subtotal	£ 6,431.00
GST	£ 321.55
Total	£ 6,752.55
Paid amount	£ 0.00
Total amount	£ 6,752.55

Please note: This quotation is only valid for acceptance for 7 days. Our estimate does not include any electrical work or additional carpentry work to install the above unless otherwise specified. Please note there is a handling charge on customer own fabric of £7.50 per metre. Due to high costs of labour, pre-arranged missed fitting appointments will be charged on a time-wasted basis. Settlement is due on completion of works and an administration charge of £25 will be added per month if unpaid within 30 days. We reserve the right to charge for design, advice and liaison work carried out should an order not be placed. Goods remain the property of CP Interiors until full settlement is received. Should payment not be received we reserve the right to attend premises during working hours to remove goods and not be required to make good. Our full terms and conditions apply and are available on request.



CP INTERIORS

QUOTE

To: Miguel Garcia
27 West Park Apartments
La Route De St Aubin
St Helier
JE2 3PZ

Job Number: SO16603 Q1
Customer Reference:
Awning

Quote Date: Monday 17 Mar 2025
Deposit required: £ 3,376.28
Your Contact: Tamara

Our Price Promise to you

We are so confident our pricing is competitive, that we will beat any written quotation for equivalent product by 5%

To supply and fit unless otherwise stated.

Location	Product	Description	Qty	Price
	Awning / Canopy	Weinor Opal Design II electrically operated awning with full cassette and vibration sensor, powder coated in one of the standard colours, in one of the My Collection fabrics available. Motor side TBC. Size 5m wide x 3m projection. Includes remote.	1	£ 6,431.00

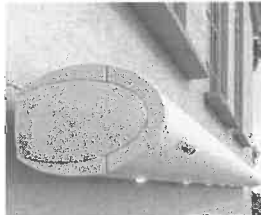

installed by CP interiors
** Awning as per above at West Park apartments*
**Electrical works not included* existing awnings*

****Subject to final measurements****

*****Please note the photo is only for reference. This quote is based on the option without the LED lights*****

Terms: 50% deposit due with order, 50% on completion

**** To go ahead with this quote please make deposit payment. To pay by card call us on 01534 768141 ****

Direct Deposit - Sort Code: 60-12-03 Account: 66577772

If you have any queries please call us on 01534 768141 or visit our showroom Rue des Pres Trading Estate St Saviour

**** For Our Terms & Conditions of Sale please go to www.cpinteriors.je ****

Subtotal	£ 6,431.00
GST	£ 321.55
Total	£ 6,752.55
Paid amount	£ 0.00
Total amount	£ 6,752.55

Please note: This quotation is only valid for acceptance for 7 days. Our estimate does not include any electrical work or additional carpentry work to install the above unless otherwise specified. Please note there is a handling charge on customer own fabric of £7.50 per metre. Due to high costs of labour, pre-arranged missed fitting appointments will be charged on a time-wasted basis. Settlement is due on completion of works and an administration charge of £25 will be added per month if unpaid within 30 days. We reserve the right to charge for design, advice and liaison work carried out should an order not be placed. Goods remain the property of CP Interiors until full settlement is received. Should payment not be received we reserve the right to attend premises during working hours to remove goods and not be required to make good. Our full terms and conditions apply and are available on request.

RB

Configuration details

weinor Ltd 73 Cornhill EC3V 3QQ London

C P Interiors

Rue Des Pres Trading Estate
GB-JE2 7QN St Saviour Jersey

reference: Garcia
Your order no.: SOL16604
weinor customernumber: 165708
creation Date: 17.03.2025
weinor pers. in charge: William Abbott
phone / fax number: +49-221-59709-472
representat.: Chris Spickett
tel (representat.): 0044 (0) 7894443907

pos	quantity	article	price
1	1	weinor Opal Design II	4.287,00
Scheduling delivery : Please contact your person in charge for planning the expected date of delivery.			
Product use : private flat			
width [cm] : 500 cm			
Projection [cm] : 300 cm			
Basic colour : WT029/90147 Approx. RAL 9007 Metallic			
Folding arm design : Arm with LongLife technology and high-tech belt			
no. of arms : 2 arms			
insulation [mm] : 0 mm			
bracket type 1 : wall fixing 150 mm Opal Design II			
number of brackets 1 : 2 Piece			
FB1 Force 1 per fixing point : 2530 N			
M = Torque per folding arm : 643 Nm			
bracket position left 1st array : 43,2 cm			
bracket position right 1st array : 43,2 cm			
type of control : RTS remote control motor Somfy			
Side of control (seen from the front) : Left			
connection cable : 100703-0000 Kabel 3G1 L3000 OE/Hipro			
Hirschmann plug? : without Hirschmann plug			
control : hand transmitter "Situ 1 RTS II"			
Type of engine : Motor Sfy Orea60RTS 55/17 1m cable +HI			
Somfy radio wind sensor RTS : with Somfy Eolis 3D WireFree RTS; white housing			
wall connection : with wall connection			
real-design : WE3-509			
colour of thread Saba : RAL 7001 Silver grey			

weinor Ltd
73 Cornhill
GB-EC3V 3QQ London
weinor.com

Managing Director:
Tim Fuldner
General partner:
Weinor Beteiligungs-GmbH
Köln

VAT no.: 335 2381 16
Company no.: 12193066
UTR no.: 33431 24084
EORI no.: GB335238116000

Domestic transfers:
Commerzbank London
Sort Code: 406201
Account Number: 307 537 10

International transfers:
Commerzbank London
IBAN: GB51 COBA 4062 0130 7537 10
Swift: MIDLGB22 a/c COBAGB2X

Configuration details

weinor Ltd 73 Cornhill EC3V 3QQ London

customer: 165708 reference: Garcia Page 2 of 2
 pos quantity article price

Cardboard container : edges reinforcement
 weight : 87 kg

value of goods	discount amount / %	net
4.287,00	1.714,80 / 40,00	2.572,20

value of goods GBP	discount amount	net GBP	VAT (0 %)	Total GBP
4.287,00	1.714,80	2.572,20	0,00	2.572,20

£6431

Configuration details

weinor Ltd 73 Cornhill EC3V 3QQ London

C P Interiors

Rue Des Pres Trading Estate
GB-JE2 7QN St Saviour Jerseyreference: García Cassita
Your order no.: SO16603 Q2
weinor customernumber: 165708
creation Date: 03.04.2025
weinor pers. in charge: William Abbott
phone / fax number: +49-221-59709-472
representat.: Chris Spickett
tel (representat.): 0044 (0) 7894443907

CASSITA SPRING CAMPAIGN

- 5.5 x 2.4

- 4.6 x 2.4

pos	quantity	article	price
1	1	weinor Cassita II spring campaign	3.137,00

Scheduling delivery	: Please contact your person in charge for planning the expected date of delivery.	
Product use	: private flat	
width (cm)	: 550 cm	
Projection [cm]	: 240 cm	3.077,00
Base colour	: WT029/10797 Approx. RAL 9010	
no. of arms	: 2 Piece	
Control type	: Somfy io control including Situo io Pure handset and Sunea io motor upgrade	
insulation [mm]	: 0 mm	
bracket type 1	: wall fixing	
number of brackets 1	: 2 Piece	60,00
FB1 Force 1 per fixing point	: 2291 N	
Torque per folding arm [Nm]	: 412 Nm	
bracket position left [mm]	: 90 mm	
bracket position right [mm]	: 90 mm	
arm position left	: 58 mm	
arm position right	: 58 mm	
type of control	: Remote-controlled motor IO Homecontrol	
Side of control (seen from the front)	: left	
control	: hand transmitter Situo 5 io II by weinor	
type of motor	: Motor Sfy Sunea50 io 40/17 ohne Zubehör	
Somfy radio wind sensor io	: with Somfy Eolis 3D WireFree io; white housing	
real-design	: WE3-515	
Glue fabric?	: no, sewn fabric	

weinor Ltd
73 Cornhill
GB-EC3V 3QQ London
weinor.comManaging Director:
Tim Földner
General partner:
Weinor Beteiligungs-GmbH
KölnVAT no.: 335 2381 16
Company no.: 12193066
UTR no.: 33431 24084
EORI no.: GB335238116000Domestic transfers:
Commerzbank London
Sort Code: 406201
Account Number: 307 537 10International transfers:
Commerzbank London
IBAN: GB51 COBA 4062 0130 7537 10
Swift: MIDLGB22 a/c COBAGB2X

Configuration details

weinor Ltd 73 Cornhill EC3V 3QQ London

customer: 165708 reference: García Cassita Page 2 of 4

pos	quantity	article	price
		colour of thread Saba : white	
		Cardboard packaging : edges reinforcement	
		weight : 66 kg	

	value of goods	discount amount / %	net
	3.137,00	1.254,80 / 40,00	1.882,20

£4706

Configuration details

weinor Ltd 73 Cornhill EC3V 3QQ London

customer: 165708 reference: García Cassita Page 3 of 4
 pos quantity article price

2 1 weinor Cassita II spring campaign 2.987,00

Scheduling delivery : Please contact your person in charge for planning the expected date of delivery.
 Product use : private flat
 width (cm) : 460 cm
 Projection [cm] : 240 cm 2.927,00
 Base colour : WT029/10797 Approx. RAL 9010
 no. of arms : 2 Piece
 Control type : Somfy io control including Situo io Pure handset and Sunea io motor upgrade
 insulation [mm] : 0 mm
 bracket type 1 : wall fixing
 number of brackets 1 : 2 Piece 60,00
 FB1 Force 1 per fixing point : 1954 N
 Torque per folding arm [Nm] : 352 Nm
 bracket position left [mm] : 90 mm
 bracket position right [mm] : 90 mm
 arm position left : 58 mm
 arm position right : 58 mm
 type of control : Remote-controlled motor IO Homecontrol
 Side of control (seen from the front) : left
 control : hand transmitter Situo 5 io II by weinor
 type of motor : Motor Sfy Sunea50 io 40/17 ohne Zubehör
 Somfy radio wind sensor io : with Somfy Eolis 3D WireFree io; white housing
 real-design : WE3-515
 Glue fabric? : no, sewn fabric
 colour of thread Saba : white
 Cardboard packaging : edges reinforcement
 weight : 59 kg

value of goods	discount amount / %	net
2.987,00	1.194,80 / 40,00	1.792,20

£4481

weinor Ltd
 73 Cornhill
 GB-EC3V 3QQ London
 weinor.com

Managing Director:
 Tim Földner
 General partner:
 Weinor Beteiligungs-GmbH
 Köln

VAT no.: 335 2381 16
 Company no.: 12193066
 UTR no.: 33431 24084
 EORI no.: GB335238116000

Domestic transfers:
 Commerzbank London
 Sort Code: 406201
 Account Number: 307 537 10

International transfers:
 Commerzbank London
 IBAN: GB51 COBA 4062 0130 7537 10
 Swift: MIDLGB22 a/c COBAGB2X

Configuration details

weinor Ltd 73 Cornhill EC3V 3QQ London

customer:	165708	reference:	García Cassita	Page 4 of 4	
pos	quantity	article			price
value of goods GBP		discount amount	net GBP	VAT (0 %)	Total GBP
6.124,00		2.449,60	3.674,40	0,00	3.674,40

Configuration details

weinor Ltd 73 Cornhill EC3V 3QQ London

C P Interiors

Rue Des Pres Trading Estate
GB-JE2 7QN St Saviour Jersey

OPAL OPTION
- 5.5 x 2.4
- 4.6 x 2.4

reference: Garcia
Your order no.: SOL16604
weinor customernumber: 165708
creation Date: 03.04.2025
weinor pers. in charge: William Abbott
phone / fax number: +49-221-59709-472
representat.: Chris Spickett
tel (representat.): 0044 (0) 7894443907

pos	quantity	article	price
1	1	weinor Opal Design II	4.137,00
		Scheduling delivery : Please contact your person in charge for planning the expected date of delivery.	
		Product use : private flat	
		width (cm) : 550 cm	
		Projection [cm] : 240 cm	3.601,00
		Base colour : WT029/10797 Approx. RAL 9010	
		Folding arm design : Arm with LongLife technology and high-tech belt	
		no. of arms : 2 arms	
		insulation [mm] : 0 mm	
		bracket type 1 : wall fixing 150 mm Opal Design II	
		number of brackets 1 : 3 Piece	123,00
		FB1 Force 1 per fixing point : 1885 N	
		Torque per folding arm [Nm] : 479 Nm	
		bracket position left 1st array : 50 cm	
		bracket position centre 1st array : 275 cm	
		bracket position right 1st array : 50 cm	
		type of control : Remote-controlled motor IO Homecontrol	139,00
		Side of control (seen from the front) : left	
		Hirschmann plug? : without Hirschmann plug	
		control : hand transmitter Situo 1 io II by weinor	73,00
		type of motor : Motor Sfy Sunea60 io 55/17- 78We-	
		Somfy radio wind sensor io : with Somfy Eolis 3D WireFree io; white housing	201,00
		real-design : WE3-515	
		colour of thread Saba : white	
		Cardboard packaging : edges reinforcement	

weinor Ltd
73 Cornhill
GB-EC3V 3QQ London
weinor.com

Managing Director:
Tim Földner
General partner:
Weinor Beteiligungs-GmbH
Köln

VAT no.: 335 2381 16
Company no.: 12193066
UTR no.: 33431 24084
EORI no.: GB335238116000

Domestic transfers:
Commerzbank London
Sort Code: 406201
Account Number: 307 537 10

International transfers:
Commerzbank London
IBAN: GB51 COBA 4062 0130 7537 10
Swift: MIDLGB22 a/c COBAGB2X

Configuration details

weinor Ltd 73 Cornhill EC3V 3QQ London

customer:	165708	reference:	Garcia	Page 2 of 3
pos	quantity	article		price
weight	: 90 kg			
		value of goods	discount amount / %	net
		4.137,00	1.654,80 / 40,00	2.482,20

£6206

Configuration details

weinor Ltd 73 Cornhill EC3V 3QQ London

customer: 165708 reference: Garcia Page 3 of 3
 pos quantity article price

2 1 weinor Opal Design II 3.947,00

Scheduling delivery : Please contact your person in charge for planning the expected date of delivery.

Product use : private flat

width (cm) : 460 cm

Projection [cm] : 240 cm 3.452,00

Base colour : WT029/10797 Approx. RAL 9010

Folding arm design : Arm with LongLife technology and high-tech belt

no. of arms : 2 arms

insulation [mm] : 0 mm

bracket type 1 : wall fixing 150 mm Opal Design II

number of brackets 1 : 2 Piece 82,00

FB1 Force 1 per fixing point : 1615 N

Torque per folding arm [Nm] : 410 Nm

bracket position left 1st array : 42,7 cm

bracket position right 1st array : 42,7 cm

type of control : Remote-controlled motor IO Homecontrol 139,00

Side of control (seen from the front) : left

Hirschmann plug? : without Hirschmann plug

control : hand transmitter Situo 1 io II by weinor 73,00

type of motor : Motor Sfy Sunea50 io 40/17- 78We-

Somfy radio wind sensor io : with Somfy Eolis 3D WireFree io; white housing 201,00

real-design : WE3-515

colour of thread Saba : white

Cardboard packaging : edges reinforcement

weight : 78 kg

	value of goods	discount amount / %	net
	3.947,00	1.578,80 / 40,00	2.368,20

£5921

value of goods GBP	discount amount	net GBP	VAT (0 %)	Total GBP
8.084,00	3.233,60	4.850,40	0,00	4.850,40