

weinor Ltd 73 Cornhill EC3V 3QQ London

C P Interiors

**Rue Des Pres Trading Estate
GB-JE2 7QN St Saviour Jersey**

delivery address

DSV Road Ltd
(NO UPS)
10 Brunel Way, Segensworth Industrial Estate
GB-PO15 5TX Hampshire, Fareham
NO UPS

ORDER CONFIRMATION (release 1)

sales order no.: 202867114 of 26.09.2024
customer: 165708
reference: BEANEY
Your order no.: SO15999
contact person: William Abbott
E-Mail: WAbbott@weinor.de
phone number: +49-221-59709-472
representat. 654 Chris Spickett
tel (representat.): 0044 (0) 7894443907

pos	quantity	article code
-----	----------	--------------

1	1,00	2745	Artares
---	------	------	---------

Information about approval : **Once the order has been approved and confirmed, you will be sent the delivery date.**

basic data

Product use	: private house	
Permissible snow load on the roof (kN/m ²)	: 0,52	
Wind load (kN/m ²)	: 0,84	
Long side fascia dimension [mm]	: 3000	mm
Short side dimension [mm]	: 7000	mm
Bottom fascia edge height [mm]	: 2450	mm
measurement	: 3000mm x 7000mm	19.468,00
Revision profile version	: Blanko-Design	
Base colour	: WT029/71289 Approx. RAL 7016	
Base colour 2	: RAL 6009 Fir green	

Attika

Vertical sun protection S1	: Continuous	1.660,00
Vertical sun protection S2	: Double-sided	3.662,00

weinor Ltd
73 Cornhill
GB-EC3V 3QQ London
weinor.com

Managing Director:
Tim Fuldner
General partner:
Weinor Beteiligungs-GmbH
Köln

VAT no.: 335 2381 16
Company no.: 12193066
UTR no.: 33431 24084
EORI no.: GB335238116000

Domestic transfers:
Commerzbank London
Sort Code: 406201
Account Number: 307 537 10

International transfers:
Commerzbank London
IBAN: GB51 COBA 4062 0130 7537 10
Swift: MIDLGB22 a/c COBAGB2X

customer: 165708 sales order 202867114

Page 2 of 11

pos	quantity	article code		
-----	----------	--------------	--	--

Vertical sun protection S3	:	Continuous		1.660,00
colour LED strip in short side fascia	:	2	Piece	1.541,00
Quantity of electronic components profiles	:	2	Piece	622,00

Lamellen

Number of louvres 190 total	:	34	Piece	
Number of standard louvres 190 with white light LED strips	:	3	Piece	1.020,00
Louvre pitch (viewed from side 3)	:	From the left to the right (side 4 - side 2)		
Louvres' direction of opening (seen from the lower side)	:	Clockwise		

operation

Power supply via	:	E1		
Operation type	:	Remote control Somfy IO		258,00
Side of control	:	E2		
With remote control	:	no		
BiConnectWith remote control BiConnect control	:	hand transmitter Situo 5 io Variation A/M II by weinor		167,00
light receiver	:	1	Piece	563,00
Somfy RGBW inkl. Netzteil 24 V 240W für Attika	:	1	Piece	607,00

Integrierte Beschattung / W17

Vertical sun protection height (frame profile bottom edge (UKR) + 180 mm to the end of the cover plate guide profile for vertical sun protection) [mm]	:	2625	0	
customised design	:	WE7-210		
Vorderseite Tuch	:	Front side of fabric outside (standard)		

Pillar(s)

weinor Ltd 73 Cornhill EC3V 3QQ London

customer: 165708 sales order 202867114

Page 3 of 11

pos	quantity	article code
-----	----------	--------------

Number of standard centre posts	: 1	Piece	482,00
page 2			
Position M3 from the left [mm]:	: 3500		
Insertion floor (mm)	: 300	mm	
Post type E1	: External post		
Post attachment E1	: Post base M		
Post type E2	: External post		
Post attachment E2	: Post base M		
Drain?	: Drain through the post		
Drain angle E2	: 90° drainage to the left		
Post type E3	: External post		
Post attachment E3	: Post base M		
Drain?	: Drain through the post		
Drain angle E3	: 90° drainage to the right		
Post type E4	: External post		
Post attachment E4	: Post base M		
Quantity of post bases for post	: 5	Piece	990,00
Quantity of Universal Artares small parts sets	: 1	Piece	

value of goods	discount amount / %	net
32.700,00	13.080,00 / 40,00	19.620,00

value of goods	discount amount	net	VAT (0 %)	Total GBP
32.700,00	13.080,00	19.620,00	0,00	19.620,00

weinor Ltd
73 Cornhill
GB-EC3V 3QQ London
weinor.com

Managing Director:
Tim Földner
General partner:
Weinor Beteiligungs-GmbH
Köln

VAT no.: 335 2381 16
Company no.: 12193066
UTR no.: 33431 24084
EORI no.: GB335238116000

Domestic transfers:
Commerzbank London
Sort Code: 406201
Account Number: 307 537 10

International transfers:
Commerzbank London
IBAN: GB51 COBA 4062 0130 7537 10
Swift: MIDLGB22 a/c COBAGB2X

In addition, our General Terms of Delivery and Payment as per 01/2024, published under the link provided below are valid and we are happy to provide you with them free of charge upon request.

<https://www.weinor.com/terms-and-conditions/>

delivery exw Cologne
payment: With direct debit 5% discount payment
mode of dispatch UK export



weinor Ltd 73 Cornhill EC3V 3QQ London

customer: 165708 sales order 202867114

Page 5 of 11

Position 1 - exterior view (images similar)

isometric view

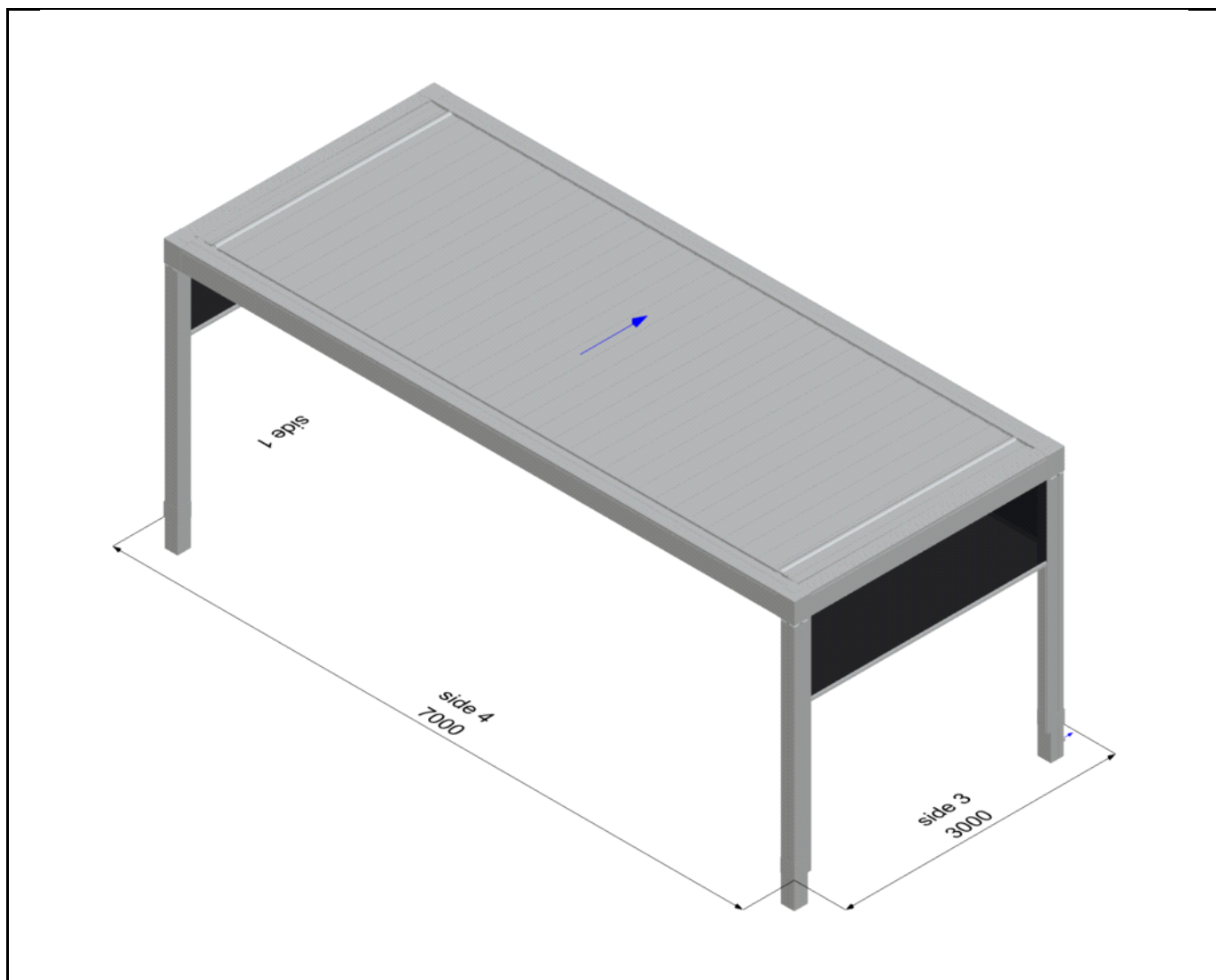

weinor Ltd
73 Cornhill
GB-EC3V 3QQ London
weinor.com

Managing Director:
Tim Fuldner
General partner:
Weinor Beteiligungs-GmbH
Köln

VAT no.: 335 2381 16
Company no.: 12193066
UTR no.: 33431 24084
EORI no.: GB335238116000

Domestic transfers:
Commerzbank London
Sort Code: 406201
Account Number: 307 537 10

International transfers:
Commerzbank London
IBAN: GB51 COBA 4062 0130 7537 10
Swift: MIDLGB22 a/c COBAGB2X



weinor Ltd 73 Cornhill EC3V 3QQ London

customer: 165708 sales order 202867114

Page 6 of 11

Position 1 - exterior view (images similar)

top view

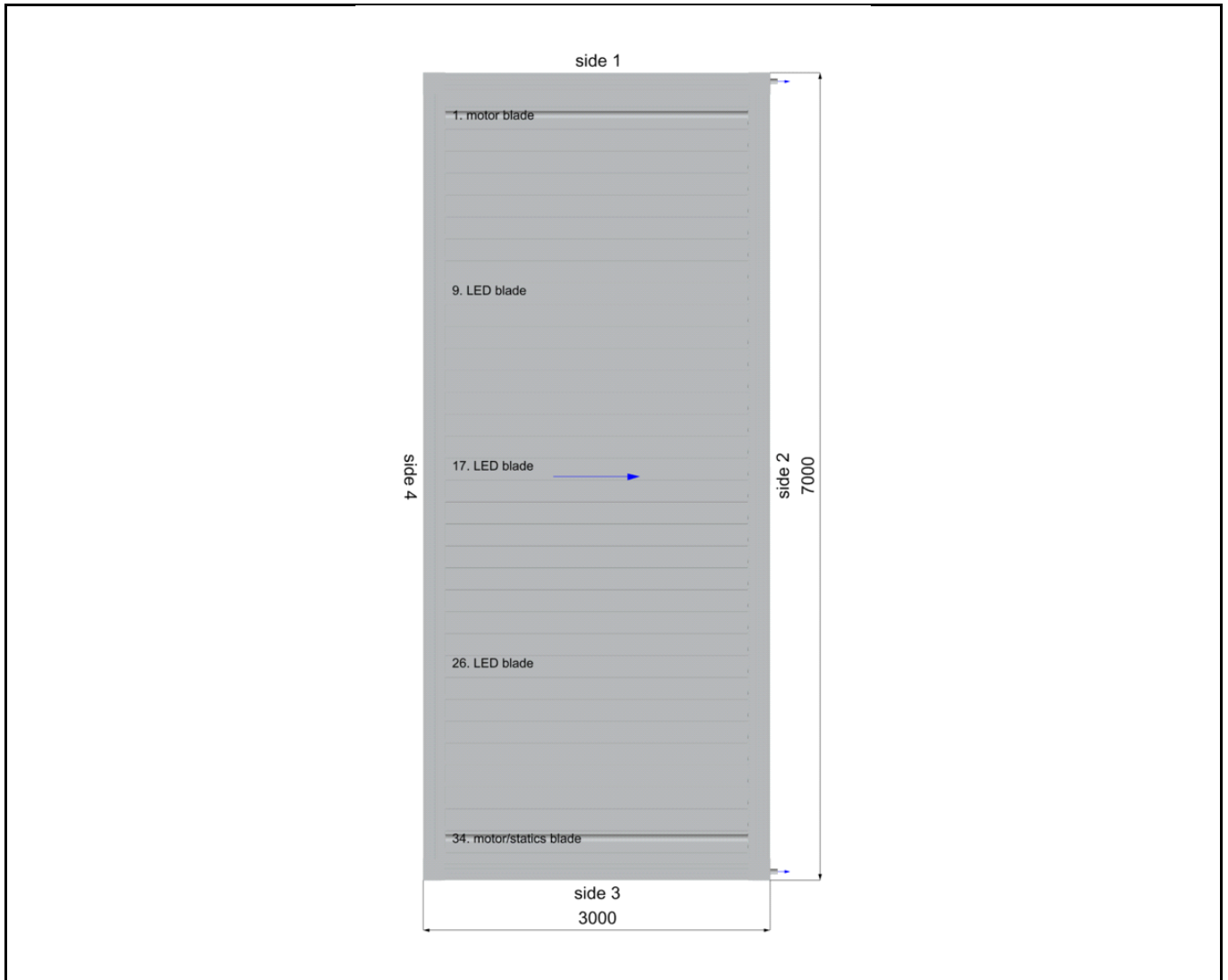

weinor Ltd
73 Cornhill
GB-EC3V 3QQ London
weinor.com

Managing Director:
Tim Fuldner
General partner:
Weinor Beteiligungs-GmbH
Köln

VAT no.: 335 2381 16
Company no.: 12193066
UTR no.: 33431 24084
EORI no.: GB335238116000

Domestic transfers:
Commerzbank London
Sort Code: 406201
Account Number: 307 537 10

International transfers:
Commerzbank London
IBAN: GB51 COBA 4062 0130 7537 10
Swift: MIDLGB22 a/c COBAGB2X



weinor Ltd 73 Cornhill EC3V 3QQ London

customer: 165708 sales order 202867114

Page 7 of 11

Position 1 - exterior view (images similar)

side view 1

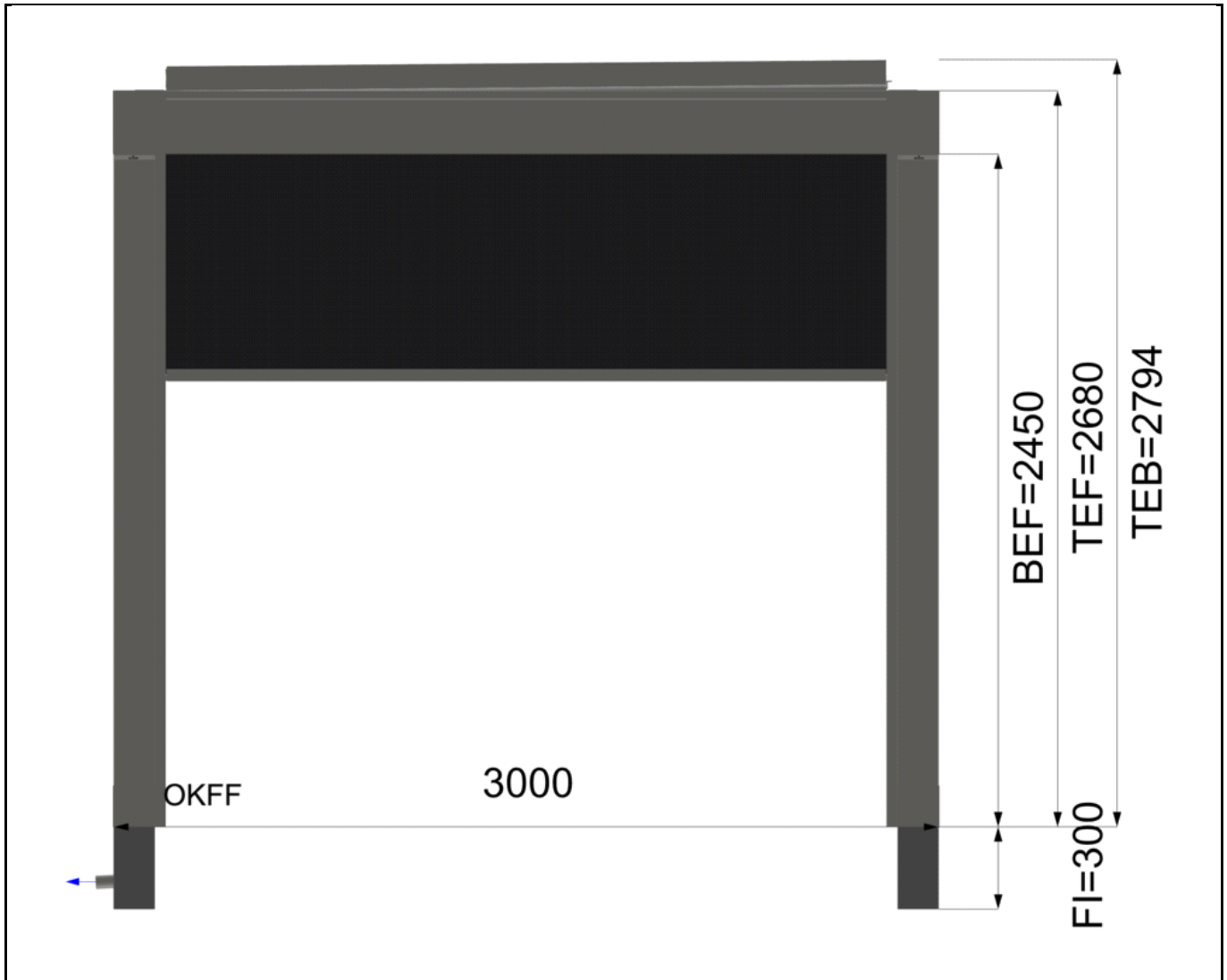

weinor Ltd
73 Cornhill
GB-EC3V 3QQ London
weinor.com

Managing Director:
Tim Földner
General partner:
Weinor Beteiligungs-GmbH
Köln

VAT no.: 335 2381 16
Company no.: 12193066
UTR no.: 33431 24084
EORI no.: GB335238116000

Domestic transfers:
Commerzbank London
Sort Code: 406201
Account Number: 307 537 10

International transfers:
Commerzbank London
IBAN: GB51 COBA 4062 0130 7537 10
Swift: MIDLGB22 a/c COBAGB2X



weinor Ltd 73 Cornhill EC3V 3QQ London

customer: 165708 sales order 202867114

Page 8 of 11

Position 1 - exterior view (images similar)

side view 2

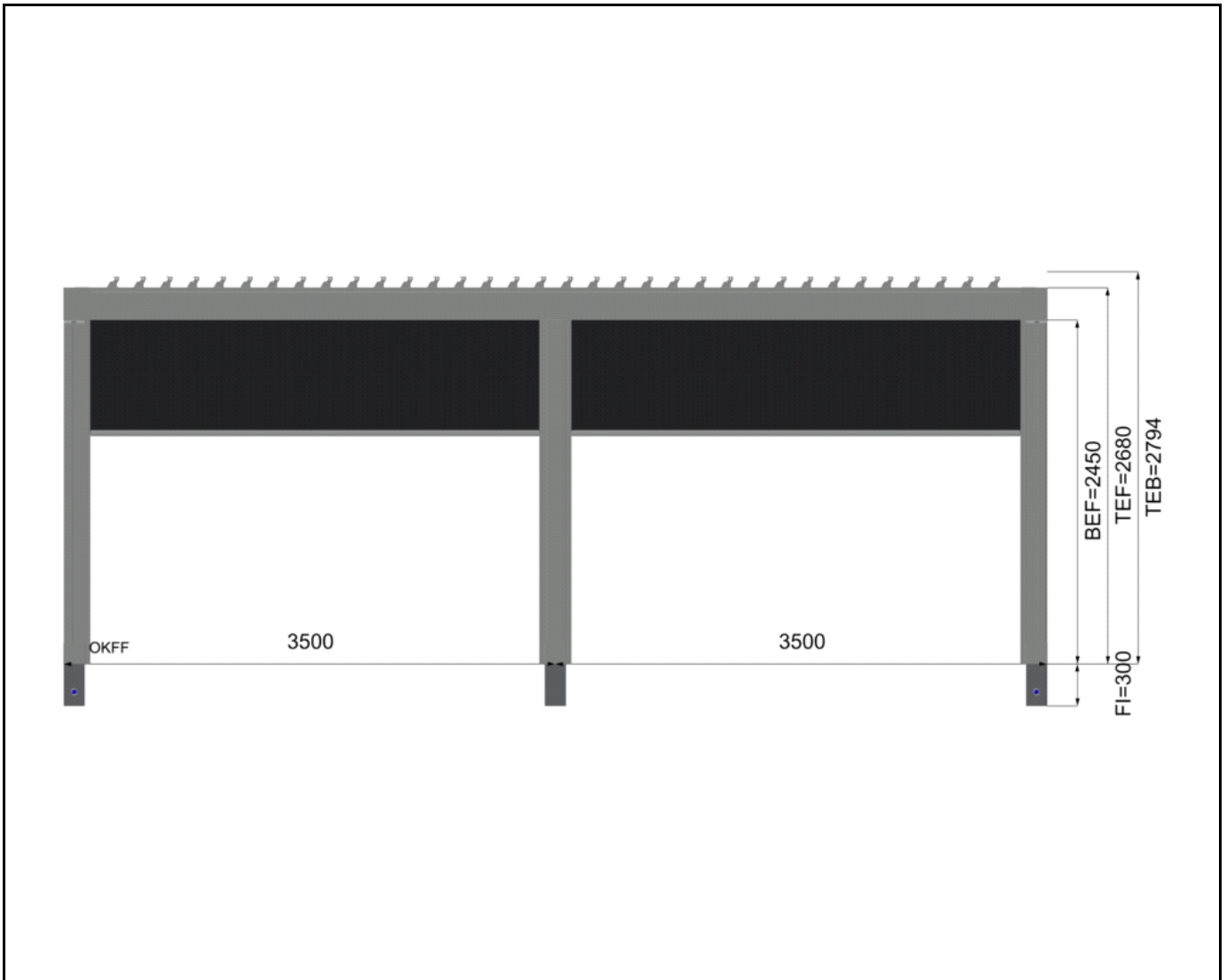

weinor Ltd
73 Cornhill
GB-EC3V 3QQ London
weinor.com

Managing Director:
Tim Földner
General partner:
Weinor Beteiligungs-GmbH
Köln

VAT no.: 335 2381 16
Company no.: 12193066
UTR no.: 33431 24084
EORI no.: GB335238116000

Domestic transfers:
Commerzbank London
Sort Code: 406201
Account Number: 307 537 10

International transfers:
Commerzbank London
IBAN: GB51 COBA 4062 0130 7537 10
Swift: MIDLGB22 a/c COBAGB2X



weinor Ltd 73 Cornhill EC3V 3QQ London

customer: 165708 sales order 202867114

Page 9 of 11

Position 1 - exterior view (images similar)

side view 3

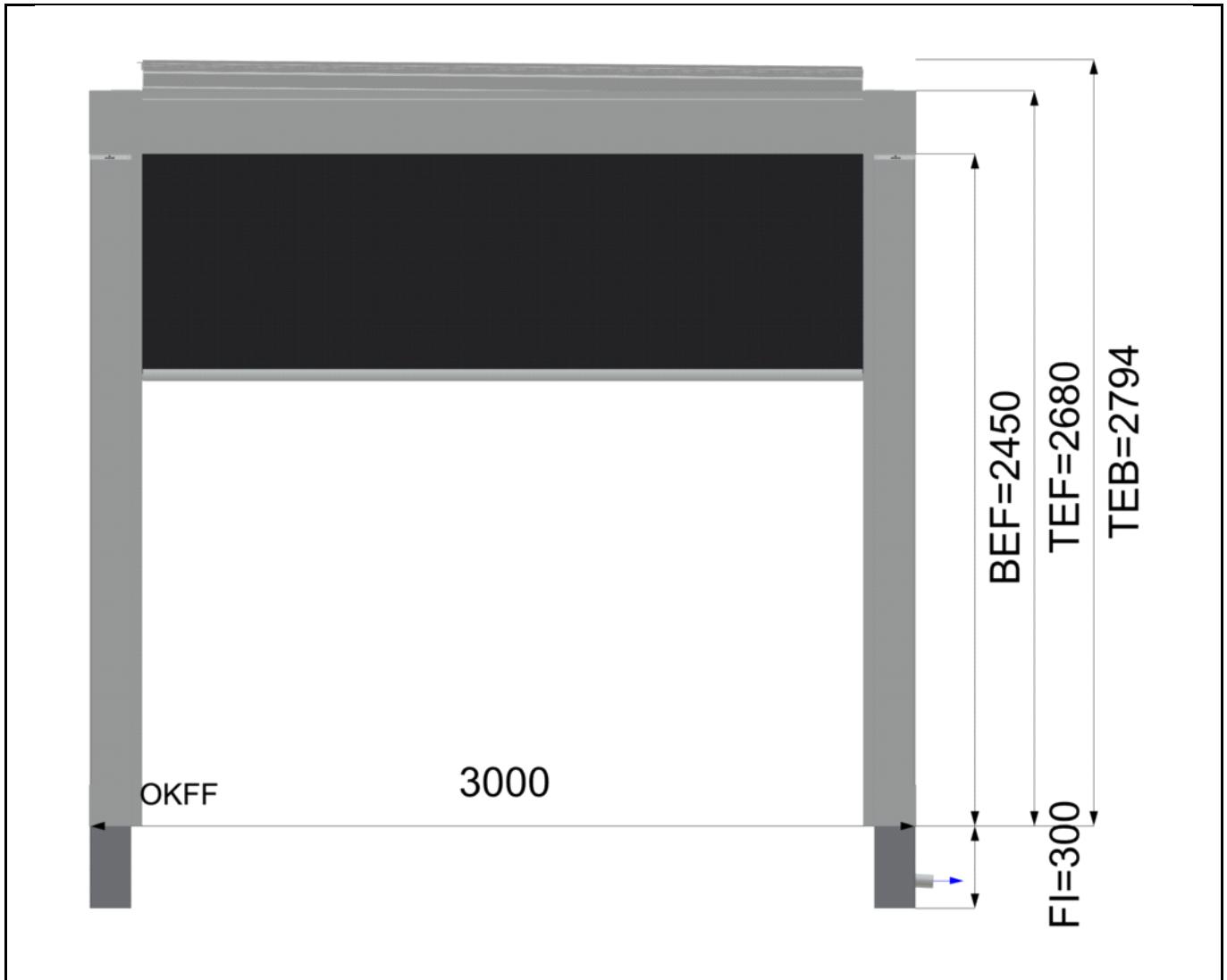

weinor Ltd
73 Cornhill
GB-EC3V 3QQ London
weinor.com

Managing Director:
Tim Földner
General partner:
Weinor Beteiligungs-GmbH
Köln

VAT no.: 335 2381 16
Company no.: 12193066
UTR no.: 33431 24084
EORI no.: GB335238116000

Domestic transfers:
Commerzbank London
Sort Code: 406201
Account Number: 307 537 10

International transfers:
Commerzbank London
IBAN: GB51 COBA 4062 0130 7537 10
Swift: MIDLGB22 a/c COBAGB2X



weinor Ltd 73 Cornhill EC3V 3QQ London

customer: 165708 sales order 202867114

Page 10 of 11

Position 1 - exterior view (images similar)

side view 4

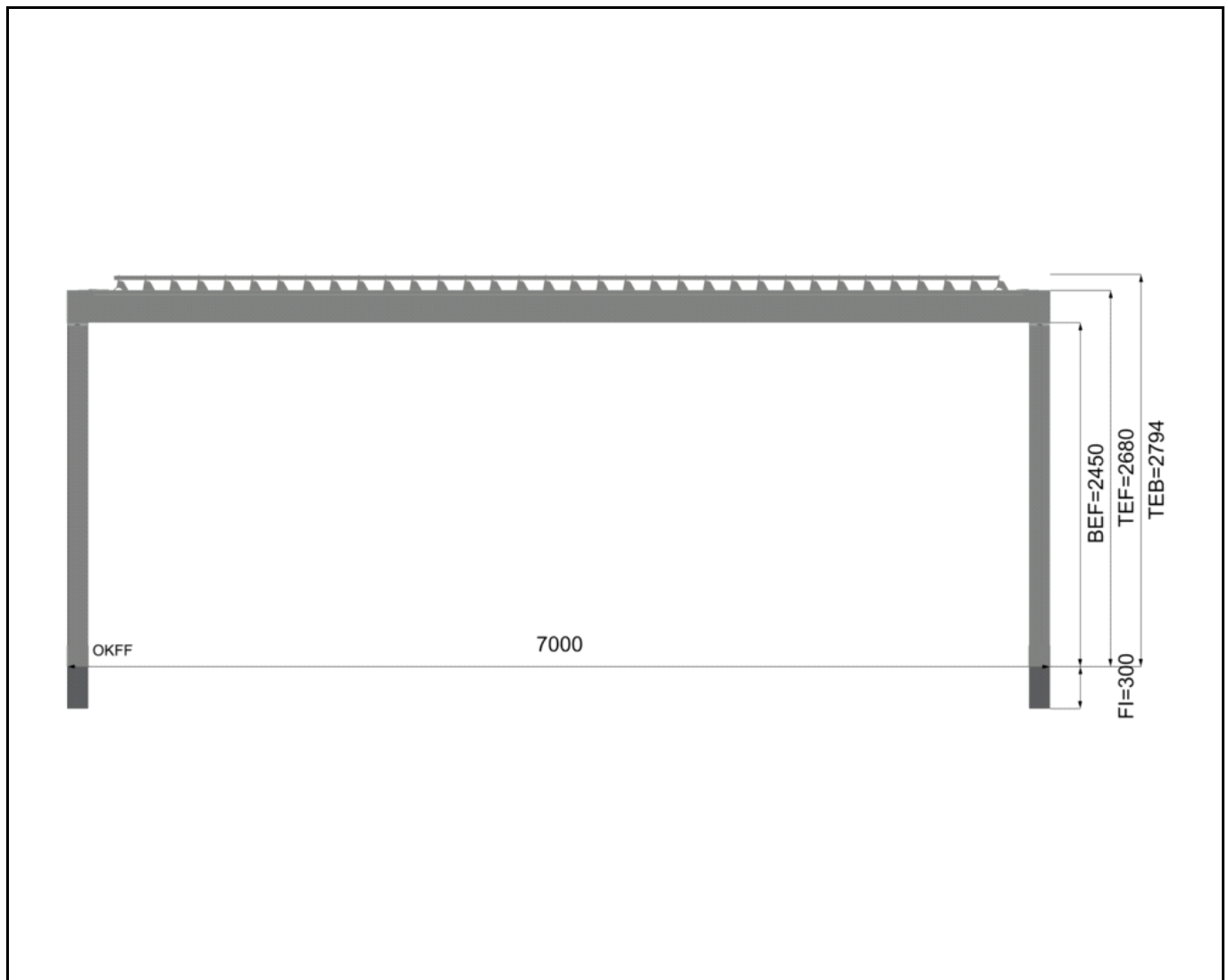

weinor Ltd
73 Cornhill
GB-EC3V 3QQ London
weinor.com

Managing Director:
Tim Földner
General partner:
Weinor Beteiligungs-GmbH
Köln

VAT no.: 335 2381 16
Company no.: 12193066
UTR no.: 33431 24084
EORI no.: GB335238116000

Domestic transfers:
Commerzbank London
Sort Code: 406201
Account Number: 307 537 10

International transfers:
Commerzbank London
IBAN: GB51 COBA 4062 0130 7537 10
Swift: MIDLGB22 a/c COBAGB2X



weinor Ltd 73 Cornhill EC3V 3QQ London

customer: 165708 sales order 202867114

Page 11 of 11

Position 1 - exterior view (images similar)

top view components

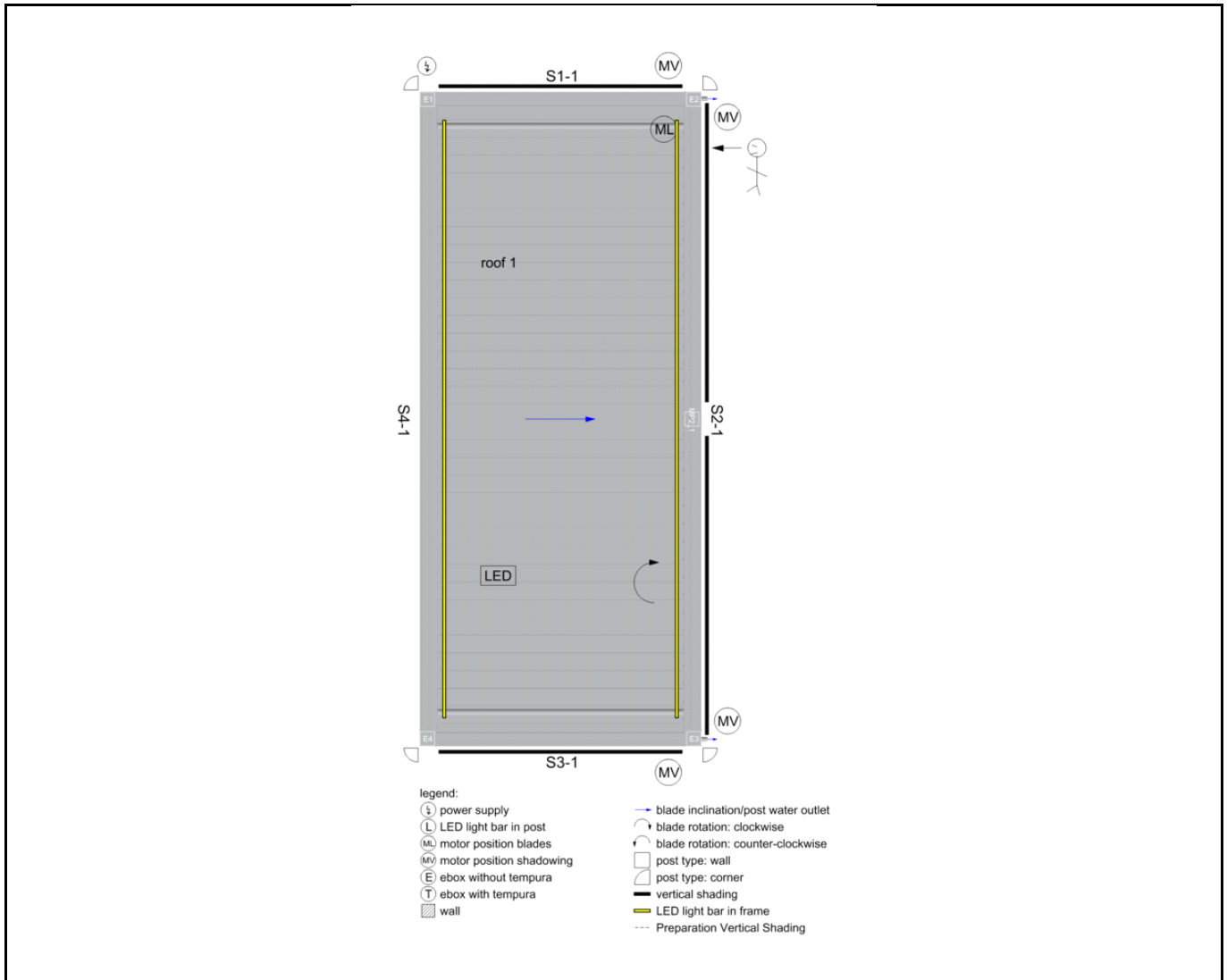

weinor Ltd
73 Cornhill
GB-EC3V 3QQ London
weinor.com

Managing Director:
Tim Fuldner
General partner:
Weinor Beteiligungs-GmbH
Köln

VAT no.: 335 2381 16
Company no.: 12193066
UTR no.: 33431 24084
EORI no.: GB335238116000

Domestic transfers:
Commerzbank London
Sort Code: 406201
Account Number: 307 537 10

International transfers:
Commerzbank London
IBAN: GB51 COBA 4062 0130 7537 10
Swift: MIDLGB22 a/c COBAGB2X