



Delivered by DSV Road Limited



SO1CI-C0E74

Deliver
CP INTERIORS
RUE DES PRESS TRADING EST
JE2 7QPST SAVIOUR
JERSEY

Phone +441534768141
Delv. --
Delv. Time
Ref 8779/24-12-1

Contact charmain wilding
Phone +44 (0) 1255 242242

Shipper
WEINOR
73 CORNHILL ROAD
LONDON
EC3V 3QQ

DELIVERY ADVICE

Consignee
CP INTERIORS
RUE DES PRESS TRADING EST
JE2 7QPST SAVIOUR
JERSEY

Date 2024-07-26
Reference SOJE33-0802 SO1CI-C0E74
Terms FREE ON BOARD
F.O.B.
JERSEY
Originating member EBOO

Coll. 2024-07-26/08:00-16:00
Unit.no DSV2022

Haulier TBA -
Reg.no DSV2022

fernando So15779 = 1x Box
Vernon Agido So15451 = 1x Box Arrived
Mackie So15625 = 1x Box 29-7-24
Kasenmyne So15650 = 2x Boxes
Kiosk So15712 = 12 Boxes
Basset So15716 = 2x Boxes

All business is transacted according to trading conditions that exclude or limit the liability of the company in certain circumstances. A copy of the relevant set of conditions will be supplied upon request.

Marks & Nos	No.of	Pkg.	Contents	Weight	KG	Volume
	8	CLL	BLINDS/AWNINGS	GW	75	0.330 CBM
				NW	75	
				EW	109	

DSV-EURPLL ____ pcs. RETURN TO DSV

ASSOCIATED FREIGHT SERVICES LTD **AFS**

I N T E R N A T I O N A L F R E I G H T F O R W A R D E R

C0E74

DELIVERY ADDRESS

CP INTERIORS C/O DSV ROAD LIMITED
10 BRUNEL WAY
SEGENSWORTH INDUSTRIAL ESTATE
FAREHAM, PO15 5TX
United Kingdom

Our reference 8816/24-12-1

Your reference 202851926

Date 22/07/2024

DELIVERY NOTE

SHIPPER:

WEINOR LIMITED
73 CORNHILL
LONDON
EC3 3QQ
United Kingdom

Special Instructions: GOODS IN UK FREE CIRCULATION

Terms of Shipment:

Number of Packages: 2 CARTONS

Gross Weight: 5.000

Description of Goods: AWNINGS/PARTS

202851926

202851895

RECEIVED:

DATE:

SIGNED:

PRINT:

PALLETS/CARTONS RECIEVED IN GOOD CONDITION

Subject to our terms and conditions, no claims for damages or shortages will be accepted unless made in writing within 7 days of delivery.

Unit 3E, Falcon Way off Central Way, Feltham, Middlesex TW14 0UQ

Tel: 020 8890 1066 - Fax: 020 8890 3398 - Email: info@afs-lon.co.uk - www.associatedfreight.co.uk

Registered office: Plaza Building, Lee High Road, London SE13 5PT - Registered in England No 2685525 - VAT No 584 4555 09

All goods are carried out in accordance with the latest standard trading conditions of BIFA



BRITISH INTERNATIONAL
FREIGHT ASSOCIATION



weinor Ltd 73 Cornhill EC3V 3QQ London

C P Interiors

Rue Des Pres Trading Estate

GB-JE2 7QN St Saviour Jersey



202851926

phone number: 0044-1534-768141
 customer: 165708
 representat: 654 Chris Spickett
 tel (representat.): 0044 (0) 7894443907

delivery note 223430955

Date of Print: 17.07.2024

delivery address

DSV Road Ltd
 (NO UPS)
 10 Brunel Way, Segensworth Industrial Estate
 GB-PO15 5TX Hampshire, Fareham

Großbritannien

NO UPS

sales order no.: 202851926
 order date: 12.07.2024
 reference: SO15779 Fernando
 Your order no.:

pos	quantity	article code
1	4	112136-0000 Hexagon socket head cap screw, DIN6912, M6x20 A2
		expected delivery date : 29.07.2024 Customer tour : 430 UK export sales unit : Piece
2	2	103568-0000 Groove block, Opal 2001, OpalDesign, Laplana, Cassita, I+K, untreated colour:
		expected delivery date : 29.07.2024 Customer tour : 430 UK export sales unit : Piece

weinor Ltd
 73 Cornhill
 GB-EC3V 3QQ London
 weinor.com

Managing Director:
 Tim Fuldner
 General partner
 Weinor Beteiligungs-GmbH
 Köln

VAT no: 335238116
 Company no: 12193066
 UTR no: 3343124084
 EOE no: GB435258116000

Domestic transfers:
 Commerzbank London
 Sort Code: 406201
 Account Number: 307 537 10

International transfers:
 Commerzbank London
 IBAN: GB21 0000 0000 0000 0000 0000
 Swift: RZLGB22 aka COEAGB2X



weinor ltd 73 Cornhill EC3V 3 2Q1 London

pos quantity article code

mode of dispatch **UK export**

date **signature**

delivery **exw Cologne**

weight **0,2 kg**

package **1 Stk.**

weinor ltd
73 Cornhill
GB-EC3V 3 2Q1 London
weinor.com

Managing Director
Tim Faldner
General partner
Weinor Beteiligungs GmbH
Köln

VAT no: 355 238116
Company no: 12195066
UTR no: 73431 24054
GBR no: GB5528816000

Domestic transfers:
Commerzbank London
Swift Code: 406201
Account Number: 307 537 10

International transfers:
Commerzbank London
IBAN: GB51 0830 4567 0130 7557 10
Swift: MIDL6572 04 COBAGB2X

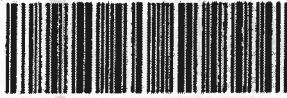

weinor Ltd 73 Cornhill EC3V 30Q London

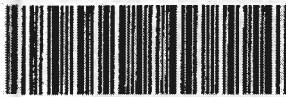
C P Interiors**Rue Des Pres Trading Estate****GB-JE2 7QN St Saviour Jersey**

202851926

phone number: 0044-1534-768141
 customer: 165708
 representat. 654 Chris Spickett
 tel (representat.): 0044 (0) 7894443907

delivery note**223430955**

Date of Print: 17.07.2024

delivery address

DSV Road Ltd
 (NO UPS)
 10 Brunel Way, Segensworth Industrial Estate
 GB-PO15 5TX Hampshire, Fareham

Großbritannien

NO UPS

sales order no.: 202851926
 order date: 12.07.2024
 reference: SO15779 Fernando
 Your order no.:

pos	quantity	article code	
1	4	112136-0000 Hexagon socket head cap screw, DIN6912, M6x20 A2	
		expected delivery date	: 29.07.2024
		Customer tour	: 430 UK export
		sales unit	: Piece
2	2	103568-0000 Groove block, Opal 2001, OpalDesign, Laplana, Cassita, I+K, untreated colour:	
		expected delivery date	: 29.07.2024
		Customer tour	: 430 UK export
		sales unit	: Piece

weinor Ltd
 73 Cornhill
 GB EC3V 30Q London
 weinor.com

Managing Director:
 Tim Fuldaier
 General partner:
 Weinor Beteiligungs GmbH
 Köln

VAT no: 335238116
 Company no: 1193066
 UTR no: 3349124664
 EORI no: G8325238116000

Domestic transfers:
 Commerzbank London
 Sort Code: 406201
 Account Number: 307 537 10

International transfers:
 Commerzbank London
 IBAN: GB51 0000 0000 0000 0000 0000
 Swift: MIDLGB22 a/c COEAGB2X



weinor Ltd 73 Cornhill EC3V 3QQ London

pos quantity article code

mode of dispatch UK export

date signature

delivery exw Cologne
 weight 0,2 kg
 package 1 Stk.

weinor Ltd
 73 Cornhill
 EC3V 3QQ London
 weinor.com

Managing Director:
 Tim Fuldner
 General partner
 Weinor Beteiligungs-GmbH
 Köln

VAT no. 335 2381 16
 Company no. 12193066
 UTR no. 3343124064
 EORI no. 6837529816000

Domestic transfers:
 Commerzbank London
 Sort Code 406201
 Account Number 3617 53710

International transfers:
 Commerzbank London
 IBAN GB51 0831 0002 0130 7557 10
 Swift MIDLGR22 #K COEAG82X

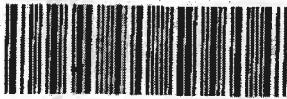

weinor Ltd. 73 Cornhill, EC3V 3QQ London

C P Interiors

Rue Des Pres Trading Estate

GB-JE2 7QN St Saviour Jersey



202851895

phone number: 0044-1534-768141
 customer: 165708
 representat. 654 Chris Spickett
 tel (representat.): 0044 (0) 7894443907

delivery note

223430953

Date of Print: 17.07.2024

delivery address

DSV Road Ltd
 (NO UPS)
 10 Brunel Way, Segensworth Industrial Estate
 GB-PO15 5TX Hampshire, Fareham

Großbritannien

NO UPS

sales order no.: 202851895
 order date: 12.07.2024
 reference: Vernon Agido SO15451
 Your order no.: SO15451

pos	quantity	article code
-----	----------	--------------

1	1	2558 BiConnect Individual components
---	---	--------------------------------------

expected delivery date : 29.07.2024
 Number of packages : 1
 weight (kg) : 5 (kg)
 Maximum package weight : 5 (kg)

mode of dispatch UK export

date signature

delivery exw Cologne
 weight 5 kg
 package 1 Stk.

weinor Ltd
 73 Cornhill
 GB-EC3V 3QQ London
 weinor.com

Managing Director:
 Tim Fuldner
 General partner:
 Weinor Beteiligungs-GmbH
 Köln

VAT no: 335 2381 16
 Company no: 12193065
 UTR no: 33431 24064
 EORI no: GB335238116000

Domestic transfers:
 Commerzbank London
 Sort Code 406201
 Account Number 307 537 10

International transfers:
 Commerzbank London
 IBAN GB51 0824 0000 0000 0000 0000
 Swift MIDLGB22 aka COBAGB2X

ASSOCIATED FREIGHT SERVICES LTD **AFS**

I N T E R N A T I O N A L F R E I G H T F O R W A R D E R S

DELIVERY ADDRESS

CP INTERIORS C/O DSV ROAD LIMITED
10 BRUNEL WAY
SEGENSWORTH INDUSTRIAL ESTATE
FAREHAM, PO15 5TX
United Kingdom

Our reference 8779/24-12-1

Your reference 202844103

Date 18/07/2024

DELIVERY NOTE

SHIPPER:

WEINOR LIMITED
73 CORNHILL
LONDON
EC3 3QQ
United Kingdom

Special Instructions: GOODS IN UK FREE CIRCULATION

Terms of Shipment:

Number of Packages: 6 CARTONS 420

Gross Weight: 70.000

Description of Goods: AWNINGS/PARTS

202844103 /
202847963 /
202848648 /
202849781 /

RECEIVED:

DATE:

SIGNED:

PRINT:

PALLETS/CARTONS RECIEVED IN GOOD CONDITION

Subject to our terms and conditions, no claims for damages or shortages will be accepted unless made in writing within 7 days of delivery. 9901

Unit 3E, Falcon Way off Central Way, Faltham, Middlesex TW14 0UQ

Tel: 020 8890 1066 - Fax: 020 8890 3398 - Email: info@afs-ion.co.uk - www.associatedfreight.co.uk

Registered office: Plaza Building, Lee High Road, London SE13 5PT - Registered in England No 2685525 - VAT No 584 4555 09

All goods are carried out in accordance with the latest standard trading conditions of BIFA

BIFA

BRITISH INTERNATIONAL
FREIGHT ASSOCIATION



weinor Ltd 73 Cornhill EC3V 3QQ London

C P Interiors

Rue Des Pres Trading Estate

GB-JE2 7QN St Saviour Jersey



202844103

phone number: 0044-1534-768141
 customer: 165708
 representat. 654 Chris Spickett
 tel (representat.): 0044 (0) 7894443907

delivery note 223428994

Date of Print: 12.07.2024

delivery address

DSV Road Ltd
 (NO UPS)
 10 Brunel Way, Segensworth Industrial Estate
 GB-PO15 5TX Hampshire, Fareham

Großbritannien

NO UPS

sales order no.: 202844103
 order date: 10.06.2024
 reference: Mackie SO15625
 Your order no.:

pos	quantity	article code	
2	1	115984-0036	Cover cap for wall bracket OpDesII colour:WT029/70786 / side:Left
		Anticipated delivery	: 22.07.2024
		customer route	: 430 UK export
		sales unit	: Piece
3	1	115984-0030	Cover cap for wall bracket OpDesII colour:WT029/70786 / side:right
		Anticipated delivery	: 22.07.2024
		customer route	: 430 UK export
		sales unit	: Piece
4	1	101800-0028	Clamp profile member, Opal, Cassita, Laplana colour:WT029/70786
		Anticipated delivery	: 22.07.2024
		customer route	: 430 UK export
		sales unit	: Piece

weinor Ltd
 73 Cornhill
 GB-EC3V 3QQ London
 weinor.com

Managing Director:
 Tim Fuldner
 General partner:
 Weinor Beteiligungs GmbH
 Köln

VAT no: 355 238116
 Company no: 12193066
 UTR no: 3343174084
 EORI no: GB355238116000

Domestic transfers:
 Commerzbank London
 Sort Code: 406201
 Account Number: 30753710

International transfers:
 Commerzbank London
 IBAN: GB51 0814 0000 0000 7537 10
 Swift: MIDLGB22 a/c: COBAGB2X

weinor Ltd 73 Cornhill EC3V 30Q London

pos quantity article code

mode of dispatch UK export

date signature

delivery exw Cologne
 weight 1 kg
 package 1 Stk.

weinor Ltd
 73 Cornhill
 GB EC3V 30Q London
 weinor.com

Managing Director:
 Tim Fuldner
 General partner:
 Weinor Beteiligungs GmbH
 Köln

VAT no: 355 239116
 Company no: 1193066
 UTR no: 33431 24084
 ECBI no: GB3352301E000

Domestic transfers:
 Commerzbank London
 Sort Code: 406201
 Account Number: 30753710

International transfers:
 Commerzbank London
 IBAN: GB51 COBA 4062 0130 7537 10
 Swift: MID1GR22 art COBAGB2X

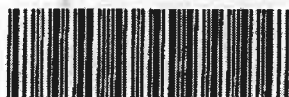

weinor Ltd 73 Cornhill EC3V 3QQ London

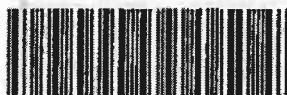
C P Interiors**Rue Des Pres Trading Estate****GB-JE2 7QN St Saviour Jersey**

202844103

phone number: 0044-1534-768141
 customer: 165708
 representat. 654 Chris Spickett
 tel (representat.): 0044 (0) 7894443907

delivery note 223428994

Date of Print: 12.07.2024

delivery address

DSV Road Ltd
 (NO UPS)
 10 Brunel Way, Segensworth Industrial Estate
 GB-PO15 5TX Hampshire, Fareham

Großbritannien

NO UPS

sales order no.: 202844103
 order date: 10.06.2024
 reference: Mackle SO15625
 Your order no.:

pos	quantity	article code		
2	1	115984-0036	Cover cap for wall bracket OpDesII colour:WT029/70786 / side:Left	
			Anticipated delivery	: 22.07.2024
			customer route	: 430 UK export
			sales unit	: Piece
3	1	115984-0030	Cover cap for wall bracket OpDesII colour:WT029/70786 / side:right	
			Anticipated delivery	: 22.07.2024
			customer route	: 430 UK export
			sales unit	: Piece
4	1	101800-0028	Clamp profile member, Opal, Cassita, Laplana colour:WT029/70786	
			Anticipated delivery	: 22.07.2024
			customer route	: 430 UK export
			sales unit	: Piece

weinor Ltd
 73 Cornhill
 GB-EC3V 3QQ London
 weinor.com

Managing Director:
 Tim Fuhrner
 General partner
 Weinor Beteiligungs-GmbH
 Köln

VAT no: 395 239116
 Company no: 12199066
 UTR no: 334 123084
 EUR no: GB35239116000

Domestic transfers:
 Commerzbank London
 Sort Code: 40620
 Account Number: 30753710

International transfers:
 Commerzbank London
 IBAN: GES1 0005 0000 0000 0000 0000 0000
 Swift: MIDLEG22 a/c COBAGB2X

weinor Ltd 73 Cornhill EC3V 3DQ London

pos quantity article code

mode of dispatch UK export

date signature

delivery exw Cologne
 weight 1 kg
 package 1 Stk.

weinor Ltd
 73 Cornhill
 GB EC3V 3DQ London
 weinor.com

Managing Director
 Tim Fuldner
 General partner
 Weinor Beteiligungs-GmbH
 Köln

VAT no: 355 2381 16
 Company no: 12193066
 UTR no: 39431 24084
 EORI no: GB335298116000

Domestic transfers:
 Commerzbank London
 Sort Code: 406201
 Account Number: 307 537 10

International transfers:
 Commerzbank London
 IBAN GB 11 0834 0062 0130 7537 10
 Swift MIDLGB22 &/& COBAGB2X



weinor Ltd 75 Cornhill EC3V 3QQ London

C P Interiors

Rue Des Pres Trading Estate

GB-JE2 7QN St Saviour Jersey

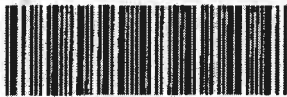

202847963

phone number: 0044-1534-768141
 customer: 165708
 representat. 654 Chris Spickett
 tel (representat.): 0044 (0) 7894443907

delivery note

Date of Print:

223429011

12.07.2024

delivery address

DSV Road Ltd
 (NO UPS)
 10 Brunel Way, Segensworth Industrial Estate
 GB-PO15 5TX Hampshire, Fareham

Großbritannien

NO UPS

sales order no.: 202847963
 order date: 26.06.2024
 reference: EASENMYNE SO15650
 Your order no.: SO15650

pos	quantity	article code
-----	----------	--------------

1 1 1400 Topas without hood

Volant VORAB - 202848428

Anticipated delivery : 22.07.2024
 Number of packages : 2
 weight : 64,82 kg
 Maximum package weight : 48,32 kg
 External dimensions : 390 X 150

mode of dispatch UK export

date signature

delivery exw Cologne
 weight 64,82 kg
 package 2 Stk.

weinor Ltd
 75 Cornhill
 GB-EC3V 3QQ London
 weinor.com

Managing Director:
 Tim Fuldner
 General partner
 Weinor Beteiligung-GmbH
 Köln

VAT no: 355238116
 Company no: 12193096
 UTR no: 3343124084
 EORI no: GB33523816090

Domestic transfers:
 Commerzbank London
 Sort Code 406201
 Account Number 30753710

International transfers:
 Commerzbank London
 IBAN: GB510804062010753710
 Swift: MIDLGB22 aka COBAG82X

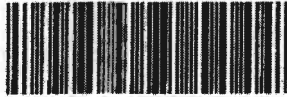

weinor Ltd 73 Cornhill EC3V 4DQ London

C P Interiors

Rue Des Pres Trading Estate

GB-JE2 7QN St Saviour Jersey

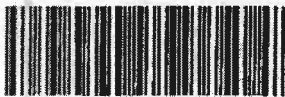

202847963

delivery note

223429011

Date of Print:

12.07.2024

delivery address

DSV Road Ltd

(NO UPS)

10 Brunel Way, Segensworth Industrial Estate

GB-PO15 5TX Hampshire, Fareham

Großbritannien

NO UPS

phone number: 0044-1534-768141
 customer: 165708
 representat. 654 Chris Spickett
 tel (representat.): 0044 (0) 7894443907

sales order no.: 202847963
 order date: 26.06.2024
 reference: EASENMYNE SO15650
 Your order no.: SO15650

pos quantity article code

1 1 1400 Topas without hood

Volant VORAB - 202848428

Anticipated delivery : 22.07.2024
 Number of packages : 2
 weight : 64,82 kg
 Maximum package weight : 48,32 kg
 External dimensions : 390 X 150

mode of dispatch UK export

date signature

delivery exw Cologne
 weight 64,82 kg
 package 2 Stk.

weinor Ltd
 73 Cornhill
 GB-EC3V 4DQ London
 weinor.com

Managing Director:
 Tm Fuldner
 General partner
 Weinor Beteiligungs-GmbH
 Köln

VAT no.: 335 238116
 Company no.: 12193066
 UTR no.: 9343124084
 EORI no.: GB35523816000

Domestic transfers:
 Commerzbank London
 Sort Code: 406201
 Account Number: 30753710

International transfers:
 Commerzbank London
 IBAN: GB510831000000000000000000
 Swift: MIDLGB33 a/c COBA62K

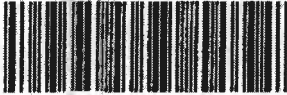

weinor Ltd 73 Cornhill EC3V 9QQ London

C P Interiors

Rue Des Pres Trading Estate

GB-JE2 7QN St Saviour Jersey



202848648

delivery note

223429017

Date of Print:

12.07.2024

delivery address

DSV Road Ltd

(NO UPS)

10 Brunel Way, Segensworth Industrial Estate

GB-PO15 5TX Hampshire, Fareham

Großbritannien

NO UPS

phone number: 0044-1534-768141
 customer: 165708
 representat. 654 Chris Spickett
 tel (representat.): 0044 (0) 7894443907

sales order no.: 202848648
 order date: 28.06.2024
 reference: Kiosk
 Your order no.: SO15748

pos quantity article code

1 1 120593-0000 Abdeckkappe DR komplett colour:9016 / side:left

Anticipated delivery : 22.07.2024

customer route : 430 UK export

sales unit : Piece

2 1 120593-0001 Abdeckkappe DR komplett colour:9016 / side:right

Anticipated delivery : 22.07.2024

customer route : 430 UK export

sales unit : Piece

weinor Ltd
 73 Cornhill
 SE8-EC3V 2QQ London
 weinor.com

Managing Director
 Tim Fuldner
 General partner
 Weinor Beteiligung GmbH
 Köln

VAT no: 335 239116
 Company no: 12193066
 UTR no: P3431 14084
 EC RI no: GB335236916000

Domestic transfers:
 Commerzbank London
 Sort Code: 406201
 Account Number: 30753710

International transfers:
 Commerzbank London
 IBAN: GB51 0804 0062 0130 7537 10
 Swift: MIDLGB22 a/c COBAGB2K

weinor Ltd 73 Cornhill EC3V 3QQ London

pos quantity article code

mode of dispatch UK export

date signature

delivery exw Cologne
 weight 1,08 kg
 package 1 Stk.

weinor Ltd
 73 Cornhill
 GB-EC3V 3QQ London
 weinor.com

Managing Director:
 Tim Fuldner
 General partner
 Weinor Beteiligungs GmbH
 Köln

VAT no: 335 2391 16
 Company no: 12193056
 UTR no: 33431 24084
 EGF no: GB335238116000

Domestic transfers:
 Commerzbank London
 Sort Code: 406201
 Account Number: 30752710

International transfers:
 Commerzbank London
 IBAN: GB55 COBA 4062 0130 7527 10
 Swift: MIDLEG62 aka COBAGB2X



weinor Ltd 73 Cornhill EC3V3QQ London

C P Interiors

Rue Des Pres Trading Estate

GB-JE2 7QN St Saviour Jersey



202848648

delivery note

223429017

Date of Print:

12.07.2024

delivery address

DSV Road Ltd
(NO UPS)
10 Brunel Way, Segensworth Industrial Estate
GB-PO15 5TX Hampshire, Fareham

Großbritannien

NO UPS

phone number: 0044-1534-768141
customer: 165708
representat. 654 Chris Spickett
tel (representat.): 0044 (0) 7894443907

sales order no.: 202848648
order date: 28.06.2024
reference; Kiosk
Your order no.: SO15748

pos	quantity	article code
1	1	120593-0000 Abdeckkappe DR komplett colour:9016 / side:Left
		Anticipated delivery : 22.07.2024
		customer route : 430 UK export
		sales unit : Piece
2	1	120593-0001 Abdeckkappe DR komplett colour:9016 / side:right
		Anticipated delivery : 22.07.2024
		customer route : 430 UK export
		sales unit : Piece

weinor Ltd
73 Cornhill
GB-EC3V3QQ London
weinor.com

Managing Director:
Tino Fuldner
General partner
Weinor Beteiligungs-GmbH
Kain

VAT no.: 355 2381 16
Company no.: 12193056
UTR no.: 33431 241 64
EOR no.: GB335238116000

Domestic transfers:
Commerzbank London
Sort Code: 406201
Account Number: 30753710
International transfers:
Commerzbank London
IBAN: GB51083100620130753710
Swift: MIDLGB22 aka COBAGB2X

weinor Ltd 73 Cornhill EC3V 3QJ London

pos quantity article code

mode of dispatch UK export

date _____ signature _____

delivery exw Cologne
weight 1,08 kg
package 1 Stk.

weinor Ltd
73 Cornhill
GB EC3V 3QJ London
weinor.cm

Managing Director
Tim Fuhler
General partner
Weinor Beteiligungs-GmbH
KG B

VAT no. 335 2381 16
Company no. 12193066
UTR no. 33431 24084
EORI no. GB335238116000

Domestic transfers:
Commerzbank London
Sort Code 406201
Account Number 307 53710

International transfers:
Commerzbank London
IBAN: GB31 0000 0000 0000 0000 0000
Swift: MIDLGB22



weinor ltd 73 Cornhill EC3V30Q London

C P Interiors

Rue Des Pres Trading Estate

GB-JE2 7QN St Saviour Jersey



202849781

delivery note

223429037

Date of Print:

12.07.2024

delivery address

DSV Road Ltd
(NO UPS)
10 Brunel Way, Segensworth Industrial Estate
GB-PO15 5TX Hampshire, Fareham

Großbritannien

NO UPS

phone number: 0044-1534-768141
customer: 165708
representat. 654 Chris Spickett
tel (representat.): 0044 (0) 7894443907

sales order no.: 202849781
order date: 03.07.2024
reference; SO15716 Barrett
Your order no.:

pos	quantity	article code
1	1	118609-0000 Kleinteileset Zenara 2.0
		Anticipated delivery : 22.07.2024
		customer route : 430 UK export
		sales unit : Piece
2	2	106293-0000 Fillister head self-tapping screw, DIN7981 C4.2x16 A2
		Anticipated delivery : 22.07.2024
		customer route : 430 UK export
		sales unit : Paket á 500 Stück

weinor ltd
73 Cornhill
GB-EC3V30Q London
weinor.com

Managing Director:
Tilm Fufilner
General partner
Weinor Beteiligungs-GmbH
Köln

VAT no: 335238116
Company no: 12193865
UTR no: 3343134084
EORI no: GB335238116000

Domestic transfers:
Commerzbank London
Sort Code 406201
Account Number 30753710

International transfers:
Commerzbank London
IBAN: GBSTCOBA40620130753710
Swift: MICHGB33 #/c COBAGB2X

weinor Ltd 73 Cornhill EC3V 3QQ London

pos	quantity	article code
-----	----------	--------------

mode of dispatch UK export

date	signature
------	-----------

delivery exw Cologne

weight 3,08 kg

package 2 Stk.

weinor Ltd
73 Cornhill
GB-EF 3V3QQ London
weinor.com

Managing Director
Tim Fuldner
General partner
Weinor Beteiligungs-GmbH
Köln

VAT no.: 35 2381 16
Company no.: 12193066
UTR no.: 3943124084
EGR no.: GB33523611E000

Domestic transfers:
Commerzbank London
Sort Code: 406201
Account Number: 30753710

International transfers:
Commerzbank London
IBAN: GB51 0084 1062 0130 7537 10
Swift: MIDLGB22 aka COBAGB2X



weinor Ltd 73 Cornhill EC3V3QQ London

C P Interiors

Rue Des Pres Trading Estate

GB-JE2 7QN St Saviour Jersey

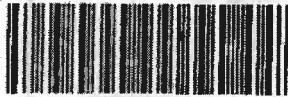

202849781

delivery note

223429037

Date of Print:

12.07.2024

delivery address

DSV Road Ltd

(NO UPS)

10 Brunel Way, Segensworth Industrial Estate

GB-PO15 5TX Hampshire, Fareham

Großbritannien

NO UPS

phone number: 0044-1534-768141
 customer: 165708
 representat. 654 Chris Spickett
 tel (representat.): 0044 (0) 7894443907

sales order no.: 202849781
 order date: 03.07.2024
 reference; SO15716 Barrett
 Your order no.:

pos	quantity	article code
1	1	118609-0000 Kleinteileset Zenara 2.0
		Anticipated delivery : 22.07.2024
		customer route : 430 UK export
		sales unit : Piece
2	2	106293-0000 Fillister head self-tapping screw, DIN7981 C4.2x16 A2
		Anticipated delivery : 22.07.2024
		customer route : 430 UK export
		sales unit : Paket á 500 Stück

weinor Ltd
 73 Cornhill
 GB-EC3V 3QQ London
 weinor.com

Managing Director:
 Tim Fuldner
 General partner
 Weinor Beteiligungs-GmbH
 Köln

VAT no : 335 238116
 Company no : 12193066
 UTR no : 33431 24084
 EORI no : GB335238116000

Domestic transfers:
 Commerzbank London
 Sort Code 406201
 Account Number 30753710
International transfers:
 Commerzbank London
 IBAN: GB51 0834 0002 0130 7537 10
 Swift: AFDLGB22 AIC08AGB2X

weinor Ltd 73 Cornhill EC3V 300 London

pos quantity article code

mode of dispatch UK export

date signature

delivery exw Cologne

weight 3,08 kg

package 2 Stk.

weinor Ltd
73 Cornhill
GB-EC3V 300 London
weinor.com

Managing Director:
Tim Fuldner
General partner
Weinor Beteiligungs-GmbH
Köln

VAT no.: 395 2381 16
Company no.: 12193066
UTR no.: 33431 24094
EORI no.: GB335238116000

Domestic transfers:
Commerzbank London
Sort Code: 406201
Account Number: 30753710
International transfers:
Commerzbank London
IBAN: GB51 093A 4062 0130 7537 10
Swift: MID: GB22 a/c COBAGB2X

Scott Ruderham

From: Scott Ruderham
Sent: Tuesday, 2 July 2024 14:15
To: Natia Veliashvili (order@weinor.de)
Cc: WAbbott@weinor.de
Subject: SO15716 Barrett - Order of Bolt for Zenara
Attachments: barrett 2.jpeg; barret 1.jpeg

Hi Natia

Hope all is well.

Attached is an end piece for a Zenara awning, think close to where the receiver is.
I need a bolt to go in as the one we had had ceased and had to have removed.

Can i please order x 1 of the bolts and have sent to us?

Kind regards,



Ruderham

Logistics/Customer Care
scott@cpinteriors.je



Unit 28 Rue Des Pres Trading Estate
St Saviour
Jersey
JE2 7QN
01534 768141 | www.cpinteriors.je
 



With our CP Price promise, we will beat any quote by 5% **
** On like for like products only

Configuration details

weinor Ltd 73 Cornhill EC3V 3QQ London

C P Interiors

Rue Des Pres Trading Estate
GB-JE2 7QN St Saviour Jersey

reference: EASENMYNE SO15650
Your order no.: SO15650
weinor customernumber: 165708
creation Date: 25.06.2024
weinor pers. in charge: William Abbott
phone / fax number: +49-221-59709-472
representat.: Chris Spickett
tel (representat.): 0044 (0) 7894443907

** valance has been sent
to torbay for sign writing
will arrive separately.*

pos	quantity	article	price
1	1	weinor Topas without hood	1.612,00

Product use	: gastronomy	
width (cm)	: 390 cm ✓	
Projection [cm]	: 150 cm ✓	1.516,00
Base colour	: WT029/90146 Approx. RAL 9006 Metallic ✓	
no. of arms	: 2 Piece	
insulation [mm]	: 0 mm	
bracket type 1	: mounting plate 660x300x15 ✓, 1 wall bracket	
number of brackets 1	: 2 Piece	354,00
FB1 Force 1 per fixing point	: 142 N	
Torque per folding arm [Nm]	: 145 Nm	
bracket position KS 2 left [mm]	: 510 mm	
bracket position KS 2 right [mm]	: 510 mm	
arm position A1 left	: 390 mm	
arm position A1 right	: 390 mm	
type of control	: crank ✓	-258,00
type of gear	: 4.4 zu 1 gear	
gear outlet	: S standard (angled 14° forwards)	
Side of control (seen from the front)	: right	
length of handle	: 180 cm	
real-design	: WE3-850 ✓	
Glue fabric?	: no, sewn fabric	
colour of thread Saba	:	
valance model	: with valance (standard) ✓	
shape	: straight ✓	
valance pattern repeat	: standard Pattern	

*Tawara checked
26/06/24*

weinor Ltd
73 Cornhill
GB-EC3V 3QQ London
weinor.com

Managing Director:
Tim Földner
General partner:
Weinor Beteiligungs-GmbH
Köln

VAT no.: 335 2381 16
Company no.: 12193066
UTR no.: 33431 24084
EORI no.: GB335238116000

Domestic transfers:
Commerzbank London
Sort Code: 406201
Account Number: 307 537 10

International transfers:
Commerzbank London
IBAN: GB51 COBA 4062 0130 7537 10
Swift: MIDLGB22 a/c COBAGB2X

weinor Ltd 73 Cornhill EC3V 3QQ London

C P Interiors

**Rue Des Pres Trading Estate
GB-JE2 7QN St Saviour Jersey**

delivery address

DSV Road Ltd
(NO UPS)
10 Brunel Way, Segensworth Industrial Estate
GB-PO15 5TX Hampshire, Fareham
NO UPS

ORDER CONFIRMATION (release 2)

sales order no.: 202844103 of 10.06.2024
customer: 165708
reference: Mackie SO15625
Your order no.:
contact person: William Abbott
E-Mail: WAbbott@weinor.de
phone number: +49-221-59709-472
representat.: 654 Chris Spickett
tel (representat.): 0044 (0) 7894443907

pos	quantity	article code
-----	----------	--------------

We will not give the warrantie in case of complaint.

Dear Customer,

We herewith confirm your order based on the dimensions specified by you.

IMPORTANT: With immediate effect, you can technically release your orders from the weinor E-shop yourself and will be provided with a delivery date immediately. Moreover, it is possible to stop orders in the weinor E-shop independently up to a specific production point.

In particular for individual components, things sometimes must go fast.

Your order will become easier and more clear if you compile it in the weinor E-shop in the future. The most important replacement parts and replacement parts sets are shown there. You can order them independently or with reference to your old order. In the latter case, your replacement parts are automatically adapted to your old order, so that the colour, length and version are calculated automatically.

Please observe that we can only name a likely delivery date after your final release. Each change requires re-engineering, thus extending the delivery period.

Please also take into account that changes to an order after release cause costs which we may have to pass on to you.

Please send the release to our telefax no.: +49 221 59709-83602 or E-mail:

weinor Ltd
73 Cornhill
GB-EC3V 3QQ London
weinor.com

Managing Director:
Tim Földner
General partner:
Weinor Beteiligungs-GmbH
Köln

VAT no.: 335 2381 16
Company no.: 12193066
UTR no.: 33431 24084
EORI no.: G8335238116000

Domestic transfers:
Commerzbank London
Sort Code: 406201
Account Number: 307537 10

International transfers:
Commerzbank London
IBAN: GB51 COBA 4062 0130 7537 10
Swift: MIDLGB22 a/c COBAGB2X

weinor Ltd 73 Cornhill EC3V 3QQ London

customer: 165708 sales order 202844103

Page 2 of 4

pos quantity article code

freigabe@weinor.de

Many thanks!

Your APPROVAL:
 (Signature) (Date)

2 1,00 115984-0036 Cover cap for wall bracket OpDesII
 colour:WT029/70786 / side:Left



Customer tour : 430

UK export

term of payment : 032

Direct debit / 3 days - 4%
 cash discount

price per unit : 22

22,00

sales unit : Piece

value of goods	discount amount / %	net
22,00	8,80 / 40,00	13,20

weinor Ltd
 73 Cornhill
 GB-EC3V 3QQ London
 weinor.com

Managing Director:
 Tim Földner
 General partner:
 Weinor Beteiligungs-GmbH
 Köln

VAT no.: 335 2381 16
 Company no.: 12193066
 UTR no.: 33431 24084
 EORI no.: GB335238116000

Domestic transfers:
 Commerzbank London
 Sort Code: 406201
 Account Number: 307 537 10

International transfers:
 Commerzbank London
 IBAN: GB51 COBA 4062 0130 7537 10
 Swift: MIDLGB22 a/c COBAGB2X

weinor Ltd 73 Cornhill EC3V 3QQ London

customer: 165708 sales order 202844103

Page 3 of 4

pos	quantity	article code
-----	----------	--------------

3	1,00	115984-0030 Cover cap for wall bracket OpDesII colour:WT029/70786 / side:right
---	------	---



Customer tour

: 430

UK export

term of payment

: 032

Direct debit / 3 days - 4%
cash discount

price per unit

: 21

21,00

sales unit**: Piece**

value of goods	discount amount / %	net
21,00	8,40 / 40,00	12,60

weinor Ltd
73 Cornhill
GB-EC3V 3QQ London
weinor.com

Managing Director:
Tim Földner
General partner:
Weinor Beteiligungs-GmbH
Köln

VAT no.: 335 2381 16
Company no.: 12193066
UTR no.: 33431 24084
EORI no.: GB335238116000

Domestic transfers:
Commerzbank London
Sort Code: 406201
Account Number: 307537 10

International transfers:
Commerzbank London
IBAN: GB51 COBA 4062 0130 7537 10
Swift: MIDLGB22 a/c COBAGB2X

weinor Ltd 73 Cornhill EC3V 3QQ London

customer: 165708 sales order 202844103

Page 4 of 4

pos quantity article code4 1,00 101800-0028 Clamp profile member, Opal, Cassita, Laplana
colour:WT029/70786

Customer tour

: 430

UK export

term of payment

: 032

Direct debit / 3 days - 4%
cash discount

price per unit

: 3,367

3,37

sales unit: **Piece**

value of goods	discount amount / %	net
3,37	1,35 / 40,00	2,02

value of goods	discount amount	net	VAT (0 %)	Total GBP
46,37	18,55	27,82	0,00	27,82

In addition, our General Terms of Delivery and Payment as per 12/2021, published under the link provided below are valid and we are happy to provide you with them free of charge upon request.

<https://www.weinor.com/terms-and-conditions/>

delivery

exw Cologne

payment:

Direct debit / 3 days - 4% cash discount

mode of dispatch

UK export

weinor Ltd
73 Cornhill
GB-EC3V 3QQ London
weinor.com

Managing Director:
Tim Földner
General partner:
Weinor Beteiligungs-GmbH
Köln

VAT no.: 335 2381 16
Company no.: 12193066
UTR no.: 33431 24084
EORI no.: GB335238116000

Domestic transfers:
Commerzbank London
Sort Code: 406201
Account Number: 307 537 10

International transfers:
Commerzbank London
IBAN: GB51 COBA 4062 0130 7537 10
Swift: MIDLGB22 a/c COBAGB2X

Scott Ruderham

From: Scott Ruderham
Sent: Monday, 10 June 2024 09:55
To: Natia Veliashvili (order@weinor.de)
Cc: WAbbott@weinor.de; Ben Reed
Subject: SO15625 Mackie - Parts Order

Sent drawings

Good Morning

From the original order below i require some parts for the Opal II awnings.

Please can i order the following:

Opal Bracket End Caps – Ref: Mackie SO15625

Left x 5
Right x 4
Bottom Cap x 1

I look forward to your confirmation.

Order no.: 201895692
Inventor: weinor
Reference: Mackie

Kind regards,

Scotty
Ruderham

Logistics/Customer Care
scott@cpinteriors.je



Unit 28 Rue Des Pres Trading Estate
St Saviour
Jersey
JE2 7QN
01534 768141 | www.cpinteriors.je
@ f



With our CP Price promise, we will beat any quote by 5% **
** On like for like products only

Opal Design II Index I, 02.10.2020

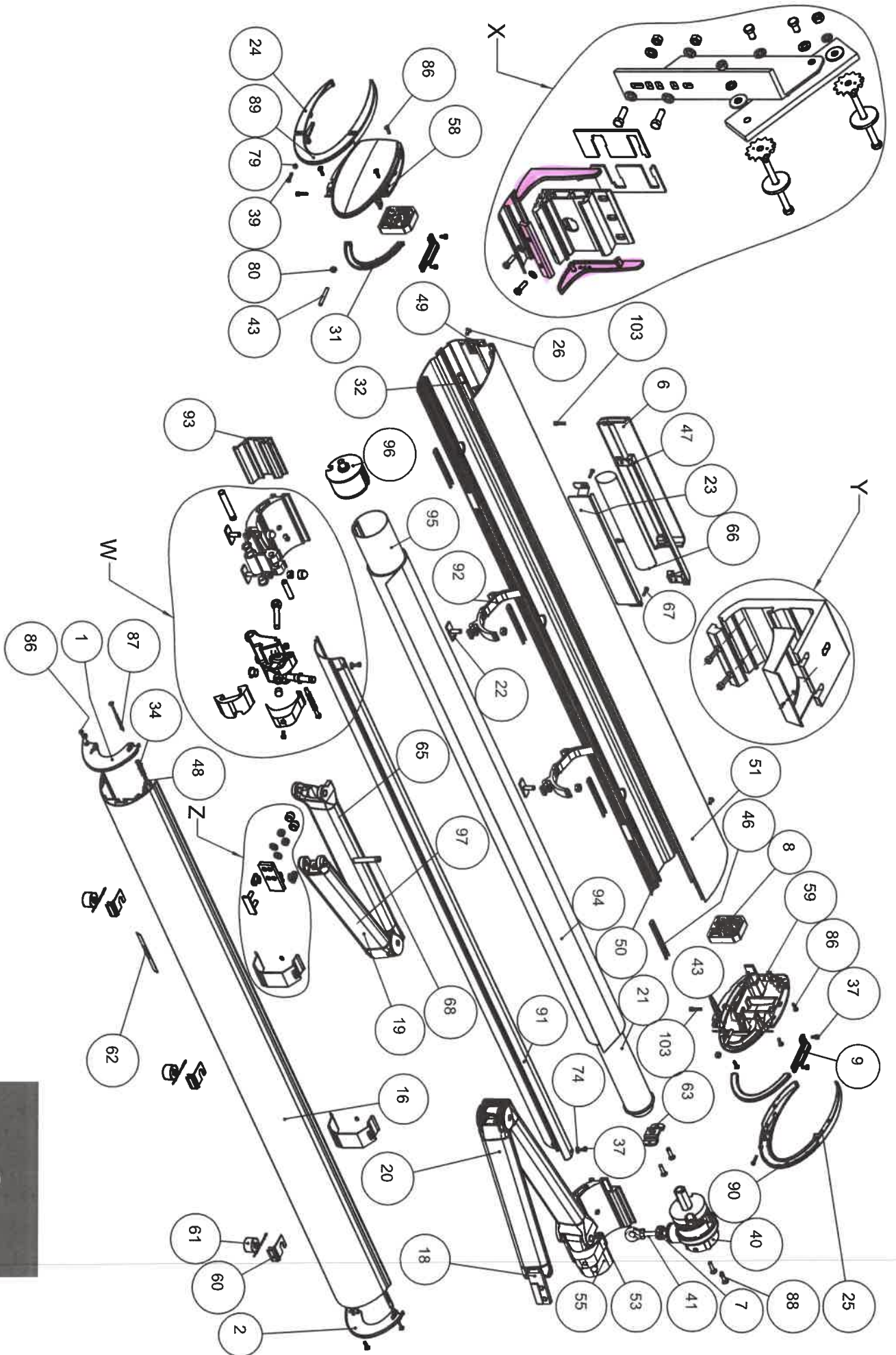

Markisen
Terrassendächer
Glasoasen

Zonnenschermen
Terrasoverkappingen
Glasoasen

awnings
patio roofs
Glasoasen

Stores
Toits de terrasse
Oasis de verre

weinoor

Opal Design II Index I, 02.10.2020

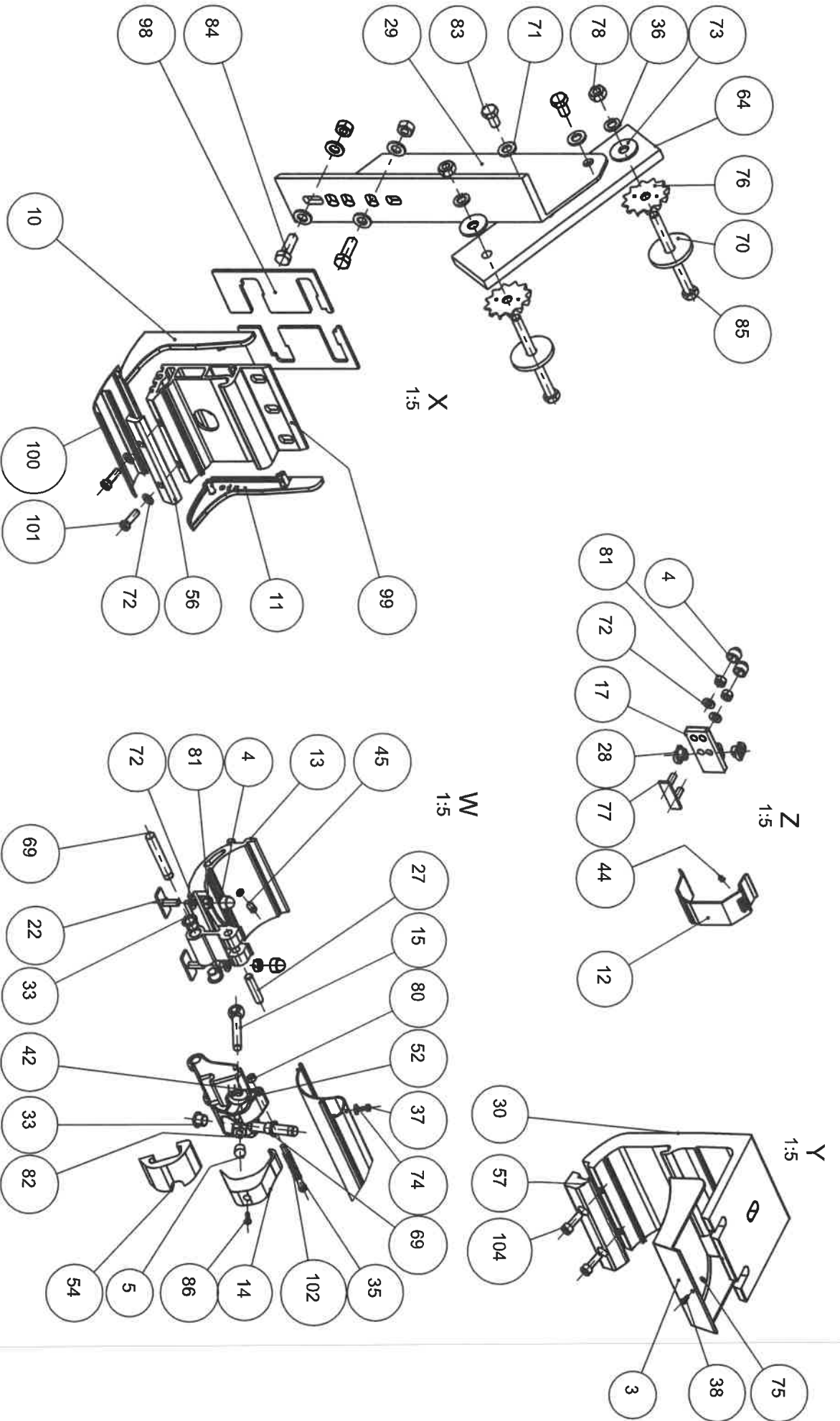

Markisen
Terrassendächer
Glasoasen

Zonenschermen
Terrasoverkappingen
Glasoasen

wnings
tiro roofs
Glasoasen

Stores
Toits de terrasse
Oasis de Verre

weinor

Opal Design II Index I, 02.10.2020

Artikelliste

Pos.	Bezeichnung	Artikelnummer roh	Artikelnummer farbig
1	Abdeckkappe Ausfallprofil links	101589	103539
2	Abdeckkappe Aufstlprofil rechts	101589	103539
3	Abdeckkappe Deckenkonsol kompakt 150 mm	118860	118861
4	Abdeckkappe SW13	100309	keine
5	Abdeckkappen D10	101806	keine
6	Abdeckung Tribolox	keine	keine
7	Achse für Getriebe D10x37,5 mm	100822	keine
8	Adapter	100132	keine
9	Adapterisierung	126986	keine
10	Abdeckkappe Wandkonsole links komplett	118336	115984
11	Abdeckkappe Wandkonsole rechts komplett	118336	115984
12	Armschlag	100384	keine
13	Armhalter	103582	103472
14	Aufhänger	100382	keine
15	Augenschraube M10x20	101820	keine
16	Ausfallprofil für Bandarm	113666	keine
17	Ausfallprofilhalter links	111202	111203
18	Ausfallprofilhalter rechts	111202	111203
19	Bandarm Longlife Arm links	keine	114455
20	Bandarm Longlife Arm rechts	keine	114455
21	Becken-Motor	keine	keine
22	Befestigungsstiften	100140	keine
23	Blechhalterung Tribolox	124833	124834
24	Blende links	101587	103540
25	Blende rechts	101587	103540
26	Blindniet ASx10	105771	keine
27	Bolzen D10x46	105444	keine
28	Bolzen Ausfallprofilhalter	110889	keine
29	Dachsparrenhalter links	110576	110580
30	Deckenkonsol kompakt 150 mm	118855	118856
31	Dichtung für Stichel	106795	keine
32	Dichtungstopf 8 mm	100174	keine
33	DÜB-Bunddrucke BB1212	107706	keine
34	Dübel IS8	100584	keine
35	Feder d10x4,5	105442	keine
36	Federling B12	105881	keine
37	Flach-Blechschraube Innensechskant 4,2x13	120026	keine
38	Flachkopfschraube Innensechskant ohne Flansch M4x10	112179	keine
39	Flachkopfschraube Innensechskant ohne Flansch M4x20	109423	keine
40	Freilaufgetriebe	keine	113489
41	Gelber Kugelnose	keine	105899
42	Gewindestift Kegeklup. DIN 913-M6x20 Turbok	113552	keine
43	Gewindestift Kegekluppe Innensechskant M6x45	105983	keine
44	Gewindestift Spitze Innensechskant M5x8	111321	keine
45	Gewindestift Spitze Innensechskant M8x16	101817	keine
46	Gleitprofil symmetrisch 14,1x6	120664	keine
47	Halterung Innenseite Trafo	124829	124830
48	Halterung 5,2 mm	101271	keine
49	Kabelklammer universel	119649	keine
50	Kassettenboden	110575	102161
51	Kassettenboden	100146	102165
52	Kippschalter links	101886	103126
53	Kippschalter rechts	101886	103126
54	Kippschalter links	106477	103479
55	Kippschalter rechts	103479	103479
56	Klemmprofilstück	101927	101800
57	Klemmstück 150mm kompakt	118858	118859
58	Kopfplatte links	126987	126988
59	Kopfplatte rechts	126987	126988
60	LED-Spot Halter 46,9	115886	115887

Artikelliste

Pos.	Bezeichnung	Artikelnummer roh	Artikelnummer farbig
61	LED-Spot komplett	114656	keine
62	Logoschild weinor	121242	keine
63	Markisenhalter becher	106385	keine
64	Montageplatte für Dachsparrenhalter	110766	110767
65	Obstarmprofil	113512	keine
66	PE-Schlauchfolie transparent 70 mm	117183	keine
67	PolyGrip-Bindenele 4x17	121246	keine
68	Rändelbolzen D10x59	107285	keine
69	Rändelbolzen D12x75	105443	keine
70	Schleife 14	112847	keine
71	Schleife 2	103258	keine
72	Schleife 8	101824	keine
73	Schleife 12	111530	keine
74	Schleife 4	100571	keine
75	Schleife universellher M4 D8	117702	keine
76	Schleibendbel C2 62/12	111687	keine
77	Schlitzen 15x34x1,5 2AM/8x22	117186	keine
78	Sechskammutter M12	100567	keine
79	Sechskammutter M4	100565	keine
80	Sechskammutter M6	120288	keine
81	Sechskammutter M8	120583	keine
82	Sechskammutter selbstsichernd M10	106192	keine
83	Sechskammutter M12x20	111696	keine
84	Sechskammutter M12x35	106211	keine
85	Sechskammutter M12x40	111698	keine
86	Senk-Schraube Innensechskant 4,2x19	121318	keine
87	Senk-Schraube Innensechskant 4,5x80/48	126114	keine
88	Senk-Schraube Innensechskant M6x25	100547	keine
89	Stichel links	101586	103538
90	Stichel rechts	101586	103538
91	Stützprofil Getriebe	keine	110804
92	Stützprofilhalter 20 mm	110803	101344
93	Trauprofil	105553	keine
94	Tuch	keine	keine
95	Tuchwelle 78x1,25	109095	keine
96	Tuchwellensatz D78 12x16	100138	keine
97	Unterarmprofil	113514	keine
98	Unterlegetafel	103566	keine
99	Wandkonsole 150 mm	115971	115972
100	Wandkonsole abdeckprofil 150	115980	keine
101	Zylinderschraube niedrig + Innensechskant + Schlussführung M8x25/22	121775	keine
102	Zylinderschraube Innensechskant M6x75	101819	keine
103	Zylinderschraube Innensechskant M4x20	100514	keine
104	Zylinderschraube Innensechskant M8x25	106277	keine

Markisen
Terrassendächer
Glasoasen

Zonnenschermen
Terrasoverkäppungen
Glasoasen

Winterrangings
Tüfttoof
Glasoasen

Stores
Tüfttoof de terrasse
Oasis de verre

Opal Design II Index I, 02.10.2020

Pos.	Beschrijving	Artikelnummer zonder coating	Artikelnummer gekleurd
1	Afdekcap uithalprofiel links	101589	103539
2	Afdekcap uithalprofiel rechts	101589	103539
3	Afdekcap platendconsole compact 150 mm	118860	118861
4	Afdekcap SW13	100309	geen
5	Afdekking D10	101806	geen
6	Afdekking raafbox	geen	geen
7	As voor drijfwerk D10x37,5	100822	geen
8	Adapter	100132	geen
9	Adaptorwielving	126986	geen
10	Afdekcap muurconsole links compleet	118336	115984
11	Afdekcap muurconsole rechts compleet	100384	115984
12	Armaanslag	100384	geen
13	Armhouter	100582	103472
14	Optoosnoeken	100382	geen
15	Oogbout M10x70	101820	geen
16	Uithalprofiel voor scharnierarm	113666	113667
17	Uithalprofielhouder links	111202	111203
18	Uithalprofielhouder rechts	111202	111203
19	Scharnierarm Longlife arm links	geen	114455
20	Scharnierarm Longlife arm rechts	geen	114455
21	Becker motor	geen	geen
22	Bewestingslede	100140	geen
23	Plathouder trafo-box	124833	124834
24	Klep links	101587	103540
25	Klep rechts	101587	103540
26	Klimknop ASx10	105771	geen
27	Bout D10x46	105444	geen
28	Bus uithalprofielhouder	110889	110580
29	Dakspanhouder links	110576	geen
30	Plafondconsole compact 150 mm	118855	118856
31	Afdichting sikkellelement	105795	geen
32	Afdichtprofiel 8 mm	100174	geen
33	DILB-bus BB1212	107206	geen
34	Plug S8	100584	geen
35	Veer d10x44,5	105442	geen
36	Veerring B12	108881	geen
37	Plaatstroef met afgelatte kop binnenzeestraand 4,2x13	120026	geen
38	Schroef met afgelatte kop binnenzeestraand zonder flens M4x10	112179	geen
39	Schroef met afgelatte kop binnenzeestraand zonder flens M4x20	106423	geen
40	Vrijlooppovertrekking	geen	113489
41	Geigel kogelroog	geen	105899
42	Steelschroef met afschuiflijn binnenzeestraand M6x45	113532	geen
43	Steelschroef met afschuiflijn binnenzeestraand M6x45	105983	geen
44	Steelschroef kegelpunt binnenzeestraand M8x16	111321	geen
45	Steelschroef kegelpunt binnenzeestraand M8x16	101817	geen
46	Glijprofiel symmetrisch 14,1x6	120664	geen
47	Houder binnenzijde zadle	124829	124830
48	Hard leder 5,2 mm	101721	geen
49	Kabeleklem universeel	119649	geen
50	Casethoedem	110575	102161
51	Casethoedek	100146	102165
52	Kantdeelschroef element links	101886	103126
53	Kantdeelschroef element rechts	101886	103126
54	Kantdeelschroef element links	106477	103479
55	Kantdeelschroef element rechts	101927	101800
56	Klemprofielstuk	101927	101800
57	Klemstuk 150 mm compact	118858	118859
58	Koppelaar links	126987	126988
59	Koppelaar rechts	126987	126988
60	Houder ledspot 46,9	115886	115887

Pos.	Beschrijving	Artikelnummer zonder coating	Artikelnummer gekleurd
61	Ledspot compleet	114636	geen
62	Logoprofiel wieloor	121242	geen
63	Zonnenschermhouder Becker	106365	geen
64	Montageplaat voor dakspanhouder	110766	110767
65	Bovenramprofiel	113512	geen
66	PE buitstole transparant 70 mm	117183	geen
67	Poly-Grip-klimknop 4x17	121246	geen
68	Karrelbout D10x59	107285	geen
69	Karrelbout D12x75	105443	geen
70	Ring 14	112847	geen
71	Scheibtel 2	103258	geen
72	Ring 8	101824	geen
73	Ring 12	111530	geen
74	Ring 4	100571	geen
75	Verzonken schijf M4 D8	117702	geen
76	Schijfving C2 62/12	111697	geen
77	Loopwerk 15x34x75 2xM8x22	117186	geen
78	Loopwerk 15x34x75 2xM8x22	100567	geen
79	Zeskantmoer M4	100565	geen
80	Zeskantmoer M6	120288	geen
81	Zeskantmoer M8	120583	geen
82	Zeskantmoer zelfborgerend M10	106192	geen
83	Zeskantmoer M12x20	111696	geen
84	Zeskantmoer M12x35	106211	geen
85	Zeskantmoer M12x40	111698	geen
86	Plaatstroef met verzonken kop binnenzeestraand 4,2x19	121318	geen
87	Schroef met verzonken kop binnenzeestraand 4,5x80/48	126114	geen
88	Schroef met verzonken kop binnenzeestraand M6x25	100547	geen
89	Sikkellelement links	101586	103538
90	Sikkellelement rechts	101586	103538
91	Steunprofiel drijfwerk	geen	geen
92	Steunprofielhouder 20 mm	110803	110804
93	draagprofiel	105553	101344
94	Doek	geen	geen
95	Doekas 78x1,25	109095	geen
96	Doekas 78x1,25	100138	geen
97	Onderarmprofiel	113514	geen
98	Onderarmplaat	103566	geen
99	Muuroconsole 150 mm	115971	115972
100	Muuroconsole afdekprofiel 150	115980	geen
101	Cilinderschroef laag + binnenzeestraand + steurgelading M8x25/22	121775	geen
102	Cilinderschroef binnenzeestraand M6x75	101819	geen
103	Cilinderschroef binnenzeestraand M4x20	100514	geen
104	Cilinderschroef binnenzeestraand M8x25	106277	geen

Markisen
Terrassendächer
Glaseisen

Zonnenschermen
Terrassoverkappingen
Glaseisen

Rooflijnings
Terraasoverkappingen
Glaseisen

Stores
Toits de terrasse
Oasis de verre



Opal Design II Index I, 02.10.2020

list of articles				GB
Item	Designation	Untreated article number	Coloured article number	
1	Left drop profile cover cap	101589	103539	
2	Right drop profile cover cap	101589	103539	
3	Compact 150 mm ceiling bracket cover cap	118860	118861	
4	SV-13 cover cap	103099	None	
5	D10 cover plug	101806	None	
6	Transformer box cover	None	None	
7	1 Axis for D10x37,5 mm gear drive	100822	None	
8	Adapter locking device	100132	None	
9	Adapter left wall bracket cover cap	126986	None	
10	Complete left wall bracket cover cap	118336	115984	
11	Complete right wall bracket cover cap	118336	115984	
12	Arm stop	100384	None	
13	Arm bracket	103582	103472	
14	Stop cam	100382	None	
15	M10 x 70 eye screw	101820	None	
16	Drop profile for belt arm	113666	113667	
17	Left drop profile holder	111202	111203	
18	Right drop profile holder	111202	111203	
19	Longlife Arm left belt arm	None	114455	
20	Longlife Arm right belt arm	None	114455	
21	Becker drive	None	None	
22	Fixing slider	100140	None	
23	Transformer box sheet metal holder	124833	124834	
24	Left facade plate	101587	103540	
25	Right facade plate	101587	103540	
26	ASx10 blind rivet	105771	None	
27	D10x46 bolts	105444	None	
28	Drop profile support bracket bushing	110889	None	
29	Left rafter bracket	110576	110580	
30	Compact 150 mm ceiling bracket	118855	118856	
31	Crescent-shaped cap seal	103795	None	
32	8 mm sealing section	100174	None	
33	B81212 DUB flanged bush	107706	None	
34	S8 dowel	100584	None	
35	d10x44,5 spring	103442	None	
36	812 circlip	105881	None	
37	4.2x13 hexalobular self-tapping screw	120026	None	
38	M4x10 hexagon flat head bolt without flange	112179	None	
39	M4x20 hexagon flat head bolt without flange	109423	None	
40	Sprag clutch	113489	None	
41	Seiger ball ear	None	105899	
42	Flat end grub screw DIN 913-M8x20 Turlok	113552	None	
43	M6x15 hexagon flat end grub screw	103983	None	
44	Pointed grub screw with M5x8 hexagon socket	111321	None	
45	Pointed grub screw with M8x16 hexagon socket	101817	None	
46	14,1x6 symmetrical glide profile	120654	None	
47	Transformer holder inside	124829	124830	
48	5.2 mm hard cord edge	101221	None	
49	Universal cable clamp	119649	None	
50	Bottom of cassette	110575	102161	
51	Cassette roof	100146	102165	
52	Left tilting member	101886	103126	
53	Right tilting member	101886	103126	
54	Left tilting part slider	106477	103479	
55	Right tilting part slider	106477	103479	
56	Compact 150 mm clamp member	101927	101800	
57	Left headplate	118858	118859	
58	Right headplate	126987	126988	
59	LED headplate	115886	115887	
60	46,0 LED spotlight holder	115886	115887	

list of articles				GB
Item	Designation	Untreated article number	Coloured article number	
61	LED spotlight, complete	114636	None	
62	weinor logo sign	121242	None	
63	Becker awning bracket	106365	None	
64	Mounting plate for rafter bracket	110766	110767	
65	Upper arm profile	113512	None	
66	70 mm PE transparent tubular film	117183	None	
67	4x17 PolyGrip blind rivet	121246	None	
68	D10x59 knurled nut with internal thread	107285	None	
69	D12x75 knurled nut with internal thread	105443	None	
70	Size 14 washer	112847	None	
71	Scheibel 12	103258	None	
72	Size 8 washer	101824	None	
73	Size 12 washer	111350	None	
74	Size 4 washer	100571	None	
75	M4 D8 underrachable washer	117702	None	
76	2 62/12 plate dowel	111697	None	
77	15x3x7,5 ZAM8x22 carriage	117186	None	
78	M12 hexagonal nut	100567	None	
79	M4 hexagonal nut	100565	None	
80	M6 hexagonal nut	100565	None	
81	M8 hexagonal nut	120288	None	
82	M10 self-locking hexagonal nut	120583	None	
83	M10x20 hex socket head screw	106192	None	
84	M12x35 hex socket head screw	106211	None	
85	M12x140 hex socket head screw	111698	None	
86	4.2x19 hexalobular countersunk chipboard screw	121318	None	
87	4.5x89/48 hexalobular countersunk self-tapping screw	126114	None	
88	M6x25 hexalobular countersunk hex head screw	100547	None	
89	Left crescent-shaped cap	101586	103538	
90	Right crescent-shaped cap	101586	103538	
91	Support profile for gear drive	None	None	
92	20 mm support section clamp	110803	110804	
93	Support profile	105553	101344	
94	Fabric	None	None	
95	78x125 roller tube	109095	None	
96	D78 12x16 roller tube insert	100138	None	
97	Lower arm profile	113514	None	
98	Base plate	103566	None	
99	150 mm wall bracket	115971	115972	
100	150 mm wall bracket top profile	115980	None	
101	M8x25/21 hexagon socket head cap screw with low profile head and centre hole	121775	None	
102	M6x75 hexagon socket head cap screw	101819	None	
103	M4x20 hexagon socket head cap screw	100514	None	
104	M8x25 hexagon socket head cap screw	106277	None	

Markisen
Terrassendächer
Glaseisen'

Zonnenschermen
Terrasoverkappingen
Glaseisen'

Roofings
to roofs
Toits de terrasse
Casis de verre'

weinor

Opal Design II Index I, 02.10.2020

Pos.	Désignation	Numero d'article brut	Numero d'article couleur
1	Cadre de protection du profilé à barre de charge, gauche	101589	103539
2	Cadre de protection de la barre de charge, droite	101589	103539
3	Cadre de protection de la console de plafond compacte, 150 mm	118860	118861
4	Cadre de protection SW13	100390	aucun
5	Boudon de recouvrement D10	101806	aucun
6	Cadre de boîtier de transformateur	aucun	aucun
7	Axe pour engrenage D10x37,5 mm	100822	aucun
8	Adaptateur	100132	aucun
9	Sécurité d'adaptateur	126986	aucun
10	Cadre de protection de la console murale, complet gauche	118336	115984
11	Cadre de protection de la console murale, complet droite	118336	115984
12	Arrêt du bras	100384	aucun
13	Support du bras	103582	103472
14	Carnas droit	100382	aucun
15	Boulon à œillet M10x70	101820	aucun
16	Barre de charge pour bande élastique	113666	113667
17	Support de la barre de charge, gauche	111202	111203
18	Support de la barre de charge, droit	111202	111203
19	Bande élastique gauche du bras Longlife	aucun	114455
20	Bande élastique droit du bras Longlife	aucun	114455
21	Moteur Becker	aucun	aucun
22	Coulisseau de fixation	100140	aucun
23	Support en tôle TrafoBox	124833	124834
24	Bandeau, gauche	101587	103540
25	Bandeau, droit	101587	103540
26	Rive aveugle ASx10	105771	aucun
27	Cheville D10x16	105444	aucun
28	Douille du support du profilé de détection	108889	aucun
29	Support gauche pour chevrons de toit	110576	110580
30	Console de plafond compacte, 150 mm	118855	118856
31	Joint pour faucille	105795	aucun
32	Profilé d'arranché 8 mm	100174	aucun
33	Douille à collet DUB 881712	107706	aucun
34	Cheville S8	100584	aucun
35	Ressort d10x44,5	105442	aucun
36	Rondelle élastique B12	105881	aucun
37	Vis à tête plate à six pans creux 4,2x13	120026	aucun
38	Vis à tête plate à six pans creux sans bride M4x 10	112179	aucun
39	Vis à tête plate à six pans creux sans bride M4x20	109423	aucun
40	Transmission à roue libre	aucun	113489
41	Élément sphérique Geiger	aucun	105899
42	Tige filetée Embout chantreine DIN 913-M8x20/101ok	113552	aucun
43	Tige filetée avec embout chantreine à six pans creux M6x45	105983	aucun
44	Tige filetée à bout pointu six pans creux M8x8	111321	aucun
45	Tige filetée à bout pointu six pans creux M8x16	101817	aucun
46	Profilé de coalescement symétrique 14,1 x 6 mm	120664	aucun
47	Support intérieur de transformateur	124829	124830
48	Bordure de cordon dure 5,2 mm	101721	aucun
49	Serre-câble universel	119649	aucun
50	Fond de la cassette	110575	102161
51	Dessus de la cassette	100146	102165
52	Pièce d'insertion, gauche	101886	103126
53	Pièce d'insertion, droite	101886	103126
54	Coulisseau de pièce d'insertion, gauche	106477	103479
55	Coulisseau de pièce d'insertion, droite	101927	101800
56	Pièce de profilé de serrage	118858	118859
57	Pièce de serrage 150 mm compacte	126987	126988
58	Tôle de recouvrement gauche	115887	115887
59	Tôle de recouvrement droite	115886	115887
60	Support de spot LED 46,9	115886	115887

Pos.	Désignation	Numero d'article brut	Numero d'article couleur
61	Spot LED complet	114636	aucun
62	Panneau logo weinor	121242	aucun
63	Support de sate Becker	106365	aucun
64	Plaque de montage pour support pour chevrons de toit	110766	110767
65	Profilé de bras supérieur	113512	aucun
66	Film tubulaire E transparent 70 mm	117185	aucun
67	Rive aveugle PolyGrip 4x17 mm	121246	aucun
68	Boulon moleté D10x39	107285	aucun
69	Boulon moleté D12x75	105443	aucun
70	Rondelle 14	112847	aucun
71	Rondelle 12	103258	aucun
72	Rondelle 8	101824	aucun
73	Rondelle 12	111530	aucun
74	Rondelle 4	100571	aucun
75	Rondelle imperdable M4 D8	117702	aucun
76	Goujon plat CZ 62/12	111697	aucun
77	Chariot 15x3x47,5-2xM8x22	117186	aucun
78	Écrou hexagonal M12	100567	aucun
79	Écrou hexagonal M4	100565	aucun
80	Écrou hexagonal M6	120288	aucun
81	Écrou hexagonal M8	120583	aucun
82	Écrou hexagonal autobloquant M10	106192	aucun
83	Vis à tête hexagonale M12x20	111696	aucun
84	Vis à tête hexagonale M12x35	106211	aucun
85	Vis à tête hexagonale M12x140	111698	aucun
86	Vis à tête à tête fraisée à six pans creux 4,2x19	121318	aucun
87	Vis pour panneau aggloméré à tête fraisée à six lobes internes 4,5x80/48	126114	aucun
88	Vis à tête conique à six pans creux M6x25	100547	aucun
89	Faucille, gauche	101586	103538
90	Faucille, droite	101586	103538
91	Profilé de support pour engrenage	aucun	aucun
92	Appui du profilé de support 20 mm	110803	110804
93	Support profilé	105553	101324
94	Toile	aucun	aucun
95	Axe d'enroulement de la toile 78x1,25	109095	aucun
96	Insert de l'axe d'enroulement D78 12x16	100138	aucun
97	Profilé de bras inférieur	113514	aucun
98	Plaque de calage	103566	aucun
99	Console murale 150 mm	115971	115972
100	Profilé de protection de la console murale 150	115980	aucun
101	Vis à tête cylindrique basse + six pans creux + trou de guidage M8x25/72	121775	aucun
102	Vis à tête cylindrique à six pans creux M6x75	101819	aucun
103	Vis à tête cylindrique à six pans creux M4x20	100514	aucun
104	Vis à tête cylindrique à six pans creux M8x25	106277	aucun

Markisen
Terrassendächer
Glascosens

Zonnenschermen
Terrasoverkappingen
Glascosens

Rings
to roofs
Glascosens

Stores
Toits de terrasse
Oasis de verre

weinor

Appointment For Ben From 31-05-2024 To 31-05-2024

Friday 31-05-2024

06:30 AM Hettich Jewellers, Mr. Jeff Chinn, King Street, St Helier, JE2 4WF, 734491, info@hettich.co.uk

SO15136 Fitter ✓ 1 re fit awning - change gear box Permit approved

08:30 AM Jersey War Tunnels Limited, Mr. Nathan Samson, Les Charrieres Malorey, St Lawrence, JE3 1FU, 07700 855578 Nathan.Samson@jerseywartunnels.com

SO15114 Fitter ✓ 10 Fit awnings ~~OK~~ possibly need awnings client will let us know to supply + fit fascia for gap above. ~~at my~~

11:30 AM Mr. Gustav Meyer, 1 Le Fourmeaux Estate, La Rue De La Corbiere, St Brelade, JE3 88P, 07797 737761, gustavmeyer@icloud.com

SO15720 Fitter ✗ 3 Adjust pitch on awning

12:30 PM Mrs. Linda Mackie, St Christopher's House, Old Beaumont Hill, St Peter, JE3 7AE, +352621237343, lindam@npsius.lu

SO15625 Fitter ✓ Ade advised visit to report on any extras required brackets etc that are corroded

13:30 PM Th2designs, Miss. Charlotte Mackenzie, 5 Printworks House, 27 Dunstable Road, Richmond, TW9 1UH, 02073491287, 02073499494, 07791779544 charlotte@th2designs.co.uk

SO15751 Measurer ✓ 1 Gulfstream - Skylight blind roof measure Andy on site 07797732979 Gulfstream, St Ouen

~~OK~~ Cassita 2.9m x 2m

- along side offer on balcony 2 x spreader plates
Colorr same as previous

Opal bracket end caps L x 5 R x 4
Bottom cor x 1

weinor Ltd 73 Cornhill EC3V 3QQ London

C P Interiors**Rue Des Pres Trading Estate
GB-JE2 7QN St Saviour Jersey****delivery address**DSV Road Ltd
(NO UPS)
10 Brunel Way, Segensworth Industrial Estate
GB-PO15 5TX Hampshire, Fareham
NO UPS**ORDER CONFIRMATION (release 2)**sales order no.: 202851926 of 12.07.2024
customer: 165708
reference: SO15779 Fernando
Your order no.:
contact person: William Abbott
E-Mail: WAbbott@weinor.de
phone number: +49-221-59709-472
representat. 654 Chris Spickett
tel (representat.): 0044 (0) 7894443907**pos quantity article code**

1 4,00 112136-0000 Hexagon socket head cap screw, DIN6912, M6x20 A2



Anticipated delivery : 29.07.2024

customer route : 430

UK export

term of payment : 032

Direct debit / 3 days - 4%
cash discount

price per unit : ,455

0,46

sales unit : Piece

value of goods	discount amount / %	net
1,84	1,84 / 100,00	0,00

weinor Ltd
73 Cornhill
GB-EC3V 3QQ London
weinor.comManaging Director:
Tim Földner
General partner:
Weinor-Beteiligungs-GmbH
KölnVAT no.: 335 2381 16
Company no.: 12193066
UTR no.: 33431 24084
EORI no.: GB335238116000**Domestic transfers:**
Commerzbank London
Sort Code: 406201
Account Number: 30753710**International transfers:**
Commerzbank London
IBAN: GB51 COBA 4062 0130 7537 10
Swift: MIDLGB22 a/c COBAGB2X

weinor Ltd 73 Cornhill EC3V 3QQ London

customer: 165708 sales order 202851926

Page 2 of 2

pos quantity article code

2 2,00 103568-0000 Groove block, Opal 2001, OpalDesign, Laplana,
Cassita, I+K, untreated
colour:raw

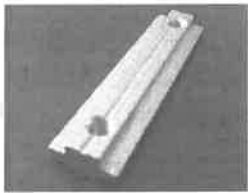

Anticipated delivery : 29.07.2024

customer route : 430

UK export

term of payment : 032

Direct debit / 3 days - 4%
cash discount

price per unit : 4,9231

4,92

sales unit : Piece

value of goods	discount amount / %	net
9,84	9,84 / 100,00	0,00

value of goods	discount amount	net	VAT (0 %)	Total GBP
11,68	11,68	0,00	0,00	0,00

In addition, our General Terms of Delivery and Payment as per 12/2021, published under the link provided below are valid and we are happy to provide you with them free of charge upon request.

<https://www.weinor.com/terms-and-conditions/>

delivery exw Cologne
payment: Direct debit / 3 days - 4% cash discount
mode of dispatch UK export

weinor Ltd
73 Cornhill
GB-EC3V 3QQ London
weinor.com

Managing Director:
Tim Földner
General partner:
WeinorBeteiligungs-GmbH
Köln

VAT no.: 335 2381 16
Company no.: 12193066
UTR no.: 33431 24084
EORI no.: GB335238116000

Domestic transfers:
Commerzbank London
Sort Code: 406201
Account Number: 30753710

International transfers:
Commerzbank London
IBAN: GB51 COBA 4062 0130 7537 10
Swift: MIDLGB22 a/c COBAGB2X

Scott Ruderham

From: Scott Ruderham
Sent: Friday, 12 July 2024 09:31
To: WAbbott@weinor.de
Cc: Natia Veliashvili (order@weinor.de); Tamara Lopez-Dominguez
Subject: FW: Your weinor offer 151190721 , customer detail: SO15779 Martin Fernando/202421556, as pdf-file
Attachments: 151190721.pdf

Good Morning William

Can I please proceed with this order:

Ref: SO15779 Fernando

Thanks
Scotty

From: WAbbott@weinor.de <WAbbott@weinor.de>
Sent: Monday, July 1, 2024 7:57 AM
To: Sales <Sales@cpinteriors.je>
Subject: Your weinor offer 151190721 , customer detail: SO15779 Martin Fernando/202421556, as pdf-file

Dear Sirs,

Thank you for your inquiry. Attached is our offer 151190721, customer information: SO15779 Martin Fernando/202421556, as pdf-file. If you have further questions please contact your weinor sales rep. William Abbott. Tel/Fax numbers: +49-221-59709-472.

Mit freundlichen Grüßen / Yours sincerely
William Abbott
Customer Center



Markisen Terrassendächer Glasoasen®

weinor GmbH & Co. KG
Mathias-Brüggen-Straße 110
50829 Köln (Germany)

Telefon: +49-221-59709-472
E-Mail: WAbbott@weinor.de

www.weinor.de

Claire Fernando
 Martin Fernando LTD
 Unit 22-24
 La Rue Sinnatt
 La Rue Des Pres Trading
 Estate
 St. Saviour
 JE2 7QT

Date	Reference	Your Contact
01-07-2024	SO15887	Tamara

Customer Ref.

Quote

Our Price Promise to you
 We are so confident our pricing is competitive, that we will beat any written quotation for equivalent product by 5%

Supply & Fit/Supply Only

Location	Description	QTY	Price
	Parts, Groove block and screws to fix awning arm to front profile.,	2	£ 36.00
	Labour: Estimate 1hr 2 men,	1	£ 138.00

Terms : 50% due with order, final 50% on completion

BACS Payment	Phone and Card Payment	Subtotal : £ 174.00	
Bank: NatWest	Payment can be made in person or by phone. If phone, please call us on 01534 768141 and have your card details ready. Note, we do not accept American Express or Cheque payments.	GST :	£ 8.70
Sort Code: 60 12 03		Total :	£ 182.70
Account No: 66577772			
Carpet Protection (C.I) Ltd T/A CP Interiors			

Please Note : LEAD TIMES ARE CURRENTLY 5 TO 12 WEEKS DEPENDING ON THE PRODUCT. This quotation is only valid for acceptance for 60 days. Our estimate does not include any electrical work or additional carpentry work to install the above unless otherwise specified. Unfortunately due to high costs of labour pre-arranged missed fitting appointments will be charged on a time-wasted basis. Settlement is due on completion of works, and an administration charge of £25 will be added per month if unpaid within 30 days. Goods remain the property of C P Sunblinds until full settlement is received.



weinor Ltd 73 Cornhill EC3V 3QQ London

C P Interiors

Rue Des Pres Trading Estate
GB-JE2 7QN St Saviour Jersey

delivery address

DSV Road Ltd
(NO UPS)
10 Brunel Way, Segensworth Industrial Estate
Hampshire, Fareham

offer (release 6)

sale offer 151190721
customer: 165708
offer date 25.06.2024
reference: SO15779 Martin Fernando/202421556
contact person: William Abbott
E-Mail WAbbott@weinor.de
phone number: +49-221-59709-472
representat. 654 Chris Spickett
tel (representat.): 0044 (0) 7894443907

quantity	article code
----------	--------------

Dear sir or madam,

we are pleased to send you this offer.

Thank you for your query. We would like to offer following items, according to our general conditions of delivery and payment and subject to a concrete assessment of the technical feasibility.

Please be advised that this quote is based on a rough planning.

For the final order an exact site measuring with a detailed planning will be necessary. Therefore dimensions and prices may vary slightly.

We hope we have been of help with this offer and are pleased to issue the order.

Please feel free to contact us at the telephone number below if you have any question.

Kind regards

i.A. William Abbott

5	4,00	112136-0000	Hexagon socket head cap screw, DIN6912, M6x20 A2
---	------	-------------	--



term of payment : 032

Direct debit / 3 days - 4%
cash discount

price per unit : ,455

0,46

sales unit : Piece

weinor Ltd
73 Cornhill
GB-EC3V 3QQ London
weinor.com

Managing Director:
Tim Fuldner
General partner:
Weinor Beteiligungs-GmbH
Köln

VAT no.: 335 2381 16
Company no.: 12193066
UTR no.: 33431 24084
EORI no.: GB335238116000

Domestic transfers:
Commerzbank London
Sort Code: 406201
Account Number: 307 537 10

International transfers:
Commerzbank London
IBAN: GB51 COBA 4062 0130 7537 10
Swift: MIDLGB22 a/c COBAGB2X

Configuration details

weinor GmbH & Co. KG Postfach 30 14 73 50784 Köln

C P Interiors

**Rue Des Pres Trading Estate
GB-JE2 7QN St Saviour Jersey**

reference: SO9594
 Your order no.: Martin Fernando
 weinor customernumber: 165708
 creation Date: 23.01.2020
 weinor pers. in charge: William Abbott
 phone / fax number: +49-221-59709-472
 representat.: Chris Spickett
 tel (representat.): 0044 (0) 7894443907

pos	quantity	article	price
Dear Weinor Partner,			
Please note: In case of a „no deal“ hard brexit import taxes become due. This fees will be invoiced to you direct by our certificated toll executing partner. Once this bill is settled you will receive your goods.			
In any other case you will receive your goods as you are used to.			
weinor GmbH & Co. KG			
1	1	weinor K 2000	3.842,00
Product use		: shop/store	
width [cm]		: 650 cm	
no. of arms		: 2 Piece	
Projection [cm]		: 400 cm	3.752,00
Basic colour		: RAL 5022 Night blue	
bracket type 1		: wall bracket 85 mm compl.	
number of brackets 1		: 5 Piece	90,00
rear wall punching		: standard	
Bracket position KS 1 left		: 495 mm	
bracket position KS 1 right		: 495 mm	
bracket position KS 2 left		: 705 mm	
bracket position KS 2 right		: 705 mm	
bracket position KS 3 [mm]		: 3105 mm	
arm position A1 left		: 602 mm	
arm position A1 right		: 602 mm	
type of control		: engine	
Side of control (seen from the front)		: right	
electrical engine connection		: 100637-0000 Kabel 4G0.75 L3000 OE/Hipro	

weinor GmbH & Co. KG
 Mathias-Brüggen-Straße 110
 50829 Köln
 weinor.de

Geschäftsführer:
 Tim Földner, Urs Neuhauser
 USt.-ID-Nr.: DE122814372
 Steuer-Nr.: 217/5866/0097
 HRA 5676
 Persönlich haftende Gesellschafterin:
 weinor Beteiligungs-GmbH, Köln
 HRB 4661

Sparkasse KölnBonn
 IBAN: DE40 3705 0198 0005 4524 53
 BIC: COLSDE33
 Commerzbank Köln
 IBAN: DE34 3708 0040 0957 6459 00
 BIC: DRESDEFF370
 Deutsche Bank Köln
 IBAN: DE76 3707 0060 0214 1430 00
 BIC: DEUTDE33XXX

Commerzbank Wien
 IBAN: AT61 1967 5001 0027 8100
 BIC: COBA ATWX
 Commerzbank Paris
 IBAN: FR76 1762 9000 0100 1187 6320 012
 BIC: COBAFRXXXX
 Commerzbank Zürich
 IBAN: CH140 8836 1200 2030 0100 (€)
 IBAN: CH300 8836 1200 2030 0006 (CHF)
 BIC: COBACHZHXXX