

PREMIER CHUCKE

CHRISTENSEN SO13137

1x Box - valance

VOISONS DEPT STONE

Sp 13837

2x Boxes 1x Curtain

ADDUM HOMES SO13549

1x Box 2x Curtains

TORRA SO13178

2x Boxes 4 3x Curtains

— -bed 213

GERMAN SO12608

2x Boxes 2x Curtains

KEURLE SO13905

2x Boxes 2x Curtains

Study | Twin
Room

APPROVED

12-1-23

RECEIVED

12 JAN 2023

SCANNED

EYELET CURTAIN ORDER FORM WEBSITE

COMPANY CP Interiors		CUSTOMER: A Keirle	ORDER REF: S013905	CONTACT NAME: Tamara
FABRIC DETAILS: Romo Dune Batik 7902/46		FABRIC WIDTH: 140cm	FABRIC REPEAT: 0cm	QUANTITY: 9m
DATE : 18/11/2022	PC PREMIUM LINING:	PC STANDARD LINING: YES	PC BLACKOUT LINING:	PC INTERLINING:
TRIM/BRAID/ BORDER :	BORDER SIZE:	TOP:	BOTTOM:	LEADING EDGE:
				RTN EDGE:
				PC SATIN FLEECE LINING:

ALL MEASUREMENTS MUST BE IN METRIC		PAIR 1	PAIR 2	PAIR 3
PAIR		Twin Room		
SINGLE				
WIDTHS PER CURTAIN				
OVERALL DROP	1500mm ✓			
HEADING HEIGHT				
TRACK SIZE	2700mm ✓			
INTERLINED - HANDSEWN				
LINED - HANDSEWN	yes			
LINED - MACHINE				
BLACKOUT - HAND				
BLACKOUT - MACHINE				

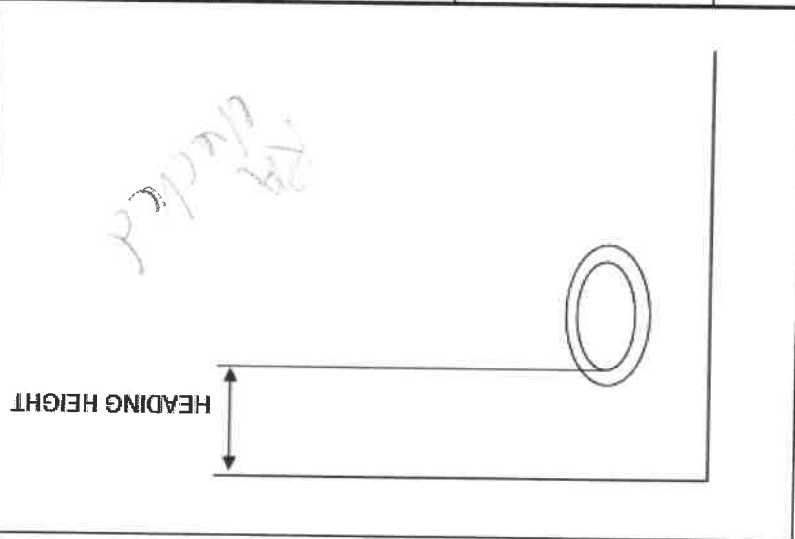

ADDITIONAL INFORMATION:
 9m of Dune Batik 7902/46 arriving from ROMO. Please use 40mm satin silver eyelets and standard lining. 1500mm drop of fabric from top of the eyelet. Eyelet to be placed 2.5cm from the top edge of the curtain (heading height).

EYELET SIZE	BLACK	BRASS	CHROME	COPPER	SATIN SILVER	ANTIQU BRASS	OLD NICKEL
25MM					YES ✓		
40MM							
50MM							
60MM							

THIS ORDER INCLUDES ON A SEPARATE SHEET (PLEASE TICK APPROPRIATE BOX)

CURTAINS

VOILE CURTAIN ORDER FORM WEBSITE

COMPANY: CP Interiors		CUSTOMER: A Keirle	ORDER REF: SO13905	CONTACT NAME: Tamara
FABRIC DETAILS: Warwick Cipriana Smoke				
DATE: 18/11/2022	PC PREMIUM LINING:	PC STANDARD LINING:	PC BLACKOUT LINING:	PC INTERLINING:
TRIM/BRAID/BORDER:	BORDER SIZE:	TOP:	BOTTOM:	LEADING EDGE:
RTN EDGE:	PC SATIN FLEECE LINING:	QUANTITY: 7m	FABRIC WIDTH: 305cm	FABRIC REPEAT: 0cm
RAIROA D:				

ALL MEASUREMENTS MUST BE IN METRIC				
PAIR	Study			
SINGLE				
WIDTHS PER CURTAIN				
OVERALL DROP	1320mm			
HOOK HEIGHT EYE DROP				
TRACK SIZE	2600mm			
STANDARD TAPE				
NET PLEAT				
SLOT				
HEADING PENCIL	YES			
HEADING TRIPLE PINCH				
HEADING DOUBLE PINCH				

ADDITIONAL INFORMATION: 7m of Cipriana Smoke arriving from Warrick. Pencil pleat header, unlined. ✓

SINGLE PLEAT & CARTRIDGE PLEAT(CIRCUMFERENCE OF PLEAT IN CM)				
CARTRIDGE FILLED OR UNFILLED				
HEADING WAVE				

Vertical weight

THIS ORDER INCLUDES ON A SEPARATE SHEET (PLEASE TICK APPROPRIATE BOX)							
EYELET SIZE	BLACK	BRASS	CHROME	COPPER	SATIN SILVER	ANTIQU BRASS	OLD NICKEL
25MM							
40MM							
50MM							
60MM							

CURTAINS

VOILE CURTAIN ORDER FORM WEBSITE

COMPANY CP Interiors		CUSTOMER: Voisins Department Store		ORDER REF: 5013837	CONTACT NAME: Rachel
FABRIC DETAILS: Ado Hector 3017/393					
DATE : 17/11/22	PC PREMIUM LINING:	PC STANDARD LINING:	PC BLACKOUT LINING:	PC INTERLINING:	PC SATIN FLEECE LINING:
TRIM/BRAID/BORDER :	BORDER SIZE:	TOP:	BOTTOM:	LEADING EDGE:	RTN EDGE:
QUANTITY : 25m	FABRIC REPEAT:	FABRIC WIDTH: 300CM	FABRIC REPEAT:	QUANTITY : 25m	D: RAILROA : Yes

ALL MEASUREMENTS MUST BE IN METRIC		PAIR 1	PAIR 2	PAIR 3	HEM
PAIR					
SINGLE	LH	LH	LH		VERTICAL WEIGHT
WIDTHS PER CURTAIN	Style advisory room	spa treatment 1	spa treatment 2		
OVERALL DROP	2290	2800	2825		
HOOK HEIGHT EYE DROP					
TRACK SIZE	1300	2450	3370		
STANDARD TAPE					
NET PLEAT					
SLOT					
HEADING PENCIL					
HEADING TRIPLE PINCH					
HEADING DOUBLE PINCH					

ADDITIONAL INFORMATION:
Fabric arriving from Ado, silent gliss headed wave tape. Style Advisory Room [3.3m allocated] Spa Treatment 1 [5.9m allocated] Spa treatment 2 [8m allocated]

SINGLE PLEAT & CARTRIDGE PLEAT(CIRCUMFERENCE OF PLEAT IN CM)		
CARTRIDGE FILLED OR UNFILLED		
HEADING WAVE	80MM	

EYELET SIZE	BLACK	BRASS	CHROME	COPPER	SATIN SILVER	ANTIQU BRASS	OLD NICKEL
25MM							
40MM							
50MM							
60MMtd >							

THIS ORDER INCLUDES ON A SEPARATE SHEET (PLEASE TICK APPROPRIATE BOX)

CURTAINS

(Amara checked 17/11/22)

Amara checked
17/11/22

VOILE CURTAIN ORDER FORM WEBSITE									
COMPANY CP Interiors		CUSTOMER: Voisins Department Store		ORDER REF: S013837		CONTACT NAME: Rachel			
FABRIC DETAILS: Ado 3017/393				FABRIC WIDTH: 300cm		FABRIC REPEAT:		QUANTITY: 25m	
DATE: 17/11/22		PC PREMIUM LINING:		PC BLACKOUT LINING:		PC INTERLINING:		PC SATIN FLEECE LINING:	
TRIM/BRAID/BORDER:		BORDER SIZE:		TOP:		BOTTOM:		LEADING EDGE:	
BORDER:		BORDER SIZE:		TOP:		BOTTOM:		RTN EDGE:	
ALL MEASUREMENTS MUST BE IN METRIC									
PAIR		PAIR 1		PAIR 2		PAIR 3		HEM	
SINGLE		LH						VERTICAL WEIGHT	
WIDTHS PER CURTAIN		Spa treatment 3							
OVERALL DROP		2825							
HOOK HEIGHT EYE DROP									
TRACK SIZE		3250							
STANDARD TAPE									
NET PLEAT									
SLOT									
HEADING PENCIL									
HEADING TRIPLE PINCH									
HEADING DOUBLE PINCH									
ADDITIONAL INFORMATION: Fabric arriving from ADO [7.8m allocated], Silent gliss wave headed tape									
SINGLE PLEAT & CARTRIDGE PLEAT(CIRCUMFERENCE OF PLEAT IN CM)									
CARTRIDGE FILLED OR UNFILED				80MM					
HEADING WAVE									
EYELET SIZE		BLACK		BRASS		CHROME		COPPER	
25MM		40MM		50MM		60MM			
OLD NICKEL		ANTIQU BRASS		SATIN SILVER		ANTIQUE BRASS			
THIS ORDER INCLUDES ON A SEPARATE SHEET (PLEASE TICK APPROPRIATE BOX)									
CURTAINS									

* Bed valance - ReMake

CUSHION/PELMET/TIEBACK ORDER FORM			
COMPANY CP Interiors		CUSTOMER: CHRISTENSEN	
FABRIC DETAILS: Romo Linara Anemone		FABRIC WIDTH: 140cm	FABRIC REPEAT:
DATE : 12/09		TRIM/BRAID/BORDER :	
NO OF PELMETS:		MAX DROP::	MIN DROP:
SHAPED BASE:		STRAIGHT BASE :	PIPED:
PELMET SIZE INCLUDING RETURNS:			
TIE BACKS SELF PIPED:		TIE BACKS CONTRAST PIPED::	
TIE BACKS		PLAIN:	
CUSHION TYPE:		SIZE :	QTY:
ADDITIONAL INFORMATION: TO MAKE BED VALANCE estimated W2040 x D1800 x H450 (please use template to replicate).			
THIS ORDER INCLUDES ON A SEPARATE SHEET (PLEASE TICK APPROPRIATE BOX)			
CONTACT NAME: Rachel	ORDER REF: S013132		

Leeana Taft

From:

Sent:

08 November 2022 11:27

To:

bookingin@premierchoice.co.uk

Subject:

Order SO13549 Andium homes

Hi

Your ref 45655

Please can you make up as follows:

Voile wave header curtains, Kobe Mosa col. 6 – silent gliss tape, snake weight hem

These are not the normal wave fullness & spacing:

1 single RH stack @ 1340mm (13.4m) flat fabric width, hooks spacing every 5 pockets. 1e first hook in 3rd pocket, 4 empty pockets, hook, 4 empty pockets..... (134 hooks)

X 2375mm drop

1 single RH stack @ 940mm (9.4m) flat fabric width, hooks spacing every 5 pockets. 1e first hook in 3rd pocket, 4 empty pockets, hook, 4 empty pockets..... (94 hooks)

X 2375mm drop

Many thanks

Leeana Taft
Director



CP INTERIORS

Tel: (01534) 768141
www.cpiinteriors.ie
Rue Des Pres Trading Estate, St Saviour, Jersey, JE2 7QP
Blinds | Curtains | Awnings | Shutters | Furnishings |
Interior Design | Project Management

*21/11 = today = Will do pre-meas.
Target install of 14/12.
Emma =*

*Raw-finish Measure 7/11
Dep. 9/11
fabric = 15/11*

CURTAIN - ELEVATION

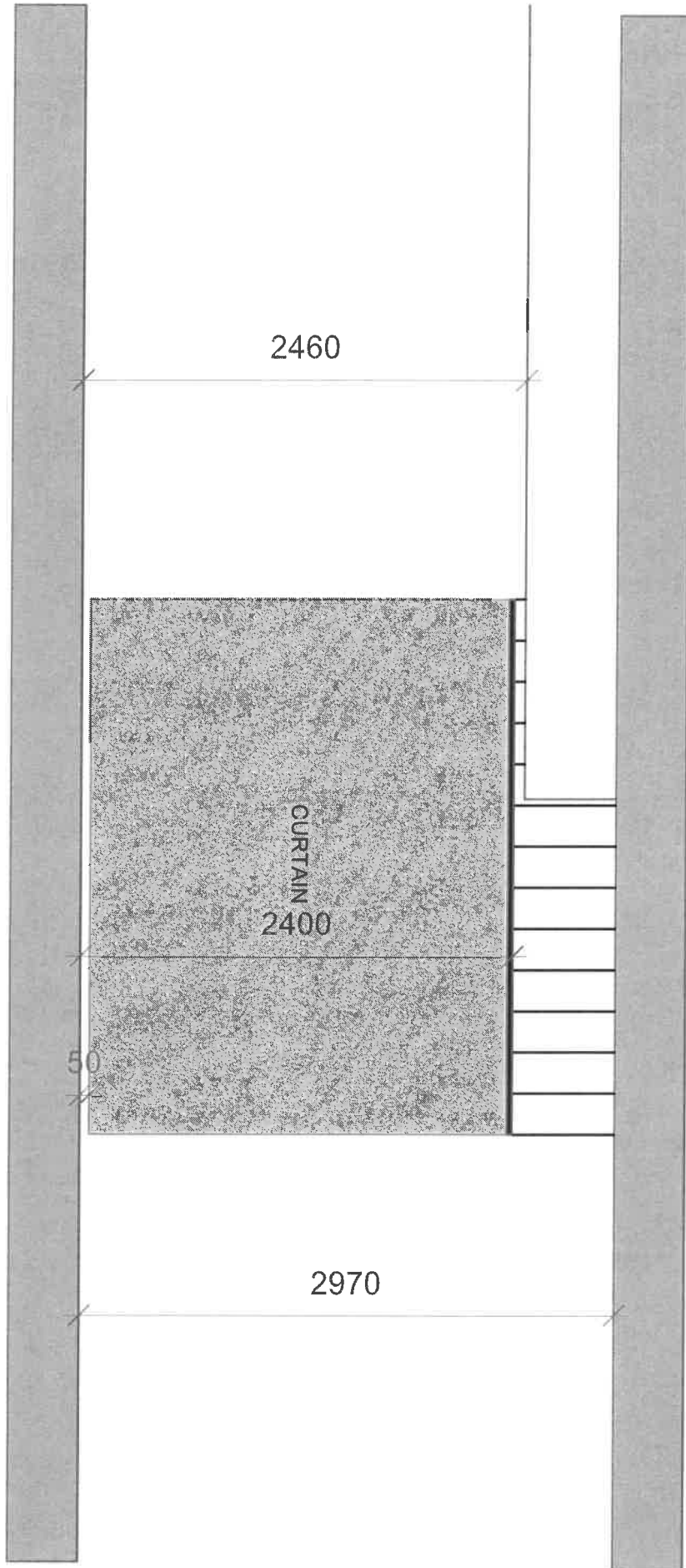

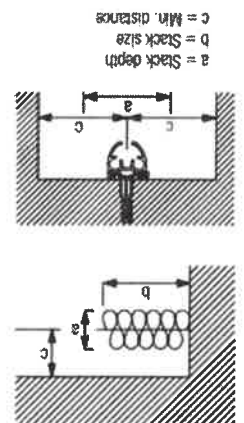

Slider cord spacing	mm	Empty pockets between hooks	Pocket Factor	Approx. curtain fullness	Stack depth (a)	Stack width (b)	Min distance (c)
80	80	7	2.3	160	160 per metre of track + endpiece	100	100
80	80	6	2.1	140	180 per metre of track + endpiece		90
60	60	5	2.3	120	230 per metre of track + endpiece		80
60	60	4	2.1	100	230 per metre of track + endpiece		70

Wave standard with roller gliders

Click on blue shaded areas to select or enter details



System	SG 6100 Hand Drawn Track (Metroflot)
track size	7808
Pair or single stack	S
Slider cord/Curtain hook spacing	60 100

Track Size EXCL

Number of hooking positions (hooks in curtain)	132
Cut Wave tape to this number of pockets (this includes 2 pockets each end for hemming)	664

Note - leading & trailing edges -
For 60mm = 3rd pocket
For 80mm = 4th pocket

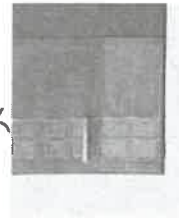

When 4 empty hooks = 80mm

+2
+10 = 674
= 13480 tape
-80
= 13400mm
Curtain

Click on blue shaded areas to select or enter details



System	SG 6100 Hand Drawn Track (Metroflot)
track size	5380
Pair or single stack	S
Slider cord/Curtain hook spacing	60 100

Track Size

Number of hooking positions (hooks in curtain)	92
Cut Wave tape to this number of pockets (this includes 2 pockets each end for hemming)	464

Note - leading & trailing edges -
For 60mm = 3rd pocket
For 80mm = 4th pocket

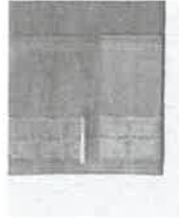

When 4 empty

+2
+10 = 474
x 80mm Pockets
= 9180mm
tape
= 9100mm
Curtain

The circle track has been put on with 11208 brackets, which allocates 13 for this size.

Ref: CP Interiors - 902818 - Track

Bay Arc

Angles & Facets: Projections & Facets LH Strings & Facets RH Strings & Facets

Facet Lengths: 3700 3400

Internal Angles: 90.0

Bend Radii: 1200

Facets: 11, 10, 9, 8, 7, 6, 5, 4, 3, 2, 1

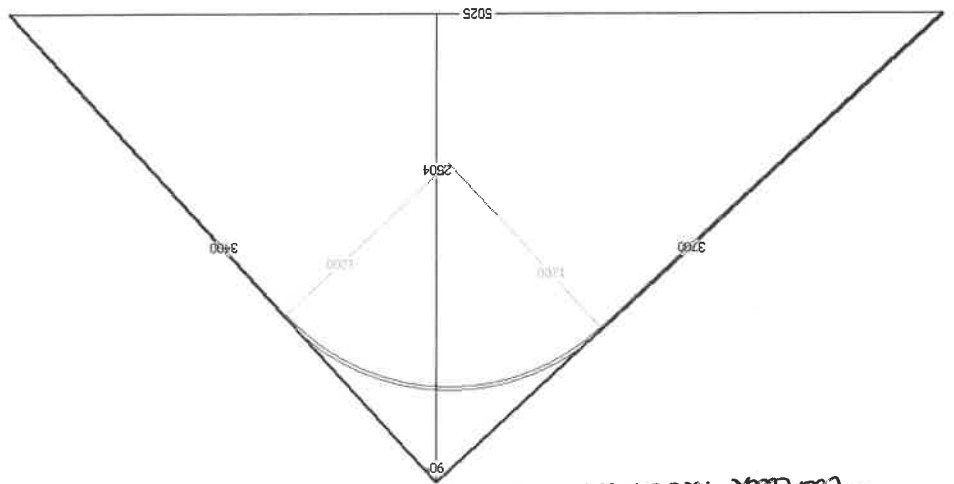

curtain 1200mm lens

Using: 7605 R200 Inc Flush Endcap - based on straight Track Sizes
 No Intermediate Pulley
 Control Location(s) - Not Specified
 Wall Length = 7100, Rail Length = 6881, Track Offset (Wall to back of Track) = -7mm

Ref: CP Interiors - 902818 - Track

713

Ref: CP Interiors - 902818 - Circle

Bay Arc

Angles & Facets: Projections & Facets LH Strings & Facets

Facet Lengths: 2450 2450

Internal Angles: 90.0

Bend Radii: 1225 1225 1225 1225

Facets: 11, 10, 9, 8, 7, 6, 5, 4, 3, 2, 1

Length: 1225

Angle: 90.0

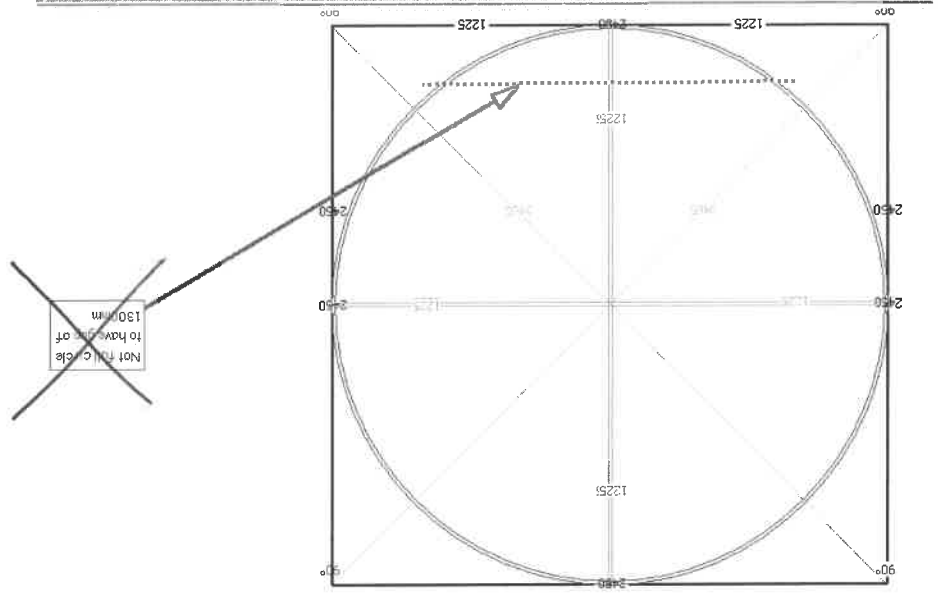

Ref: CP Interiors - 902818 - Circle

Using: 7605 R200 Inc Flush Endcap - based on straight Track Sizes
 No Intermediate Pulley
 Control Location(s) - Not Specified
 Wall Length = 9800, Rail Length = 7808, Track Offset (Wall to back of Track) = -7mm (Returns -7mm)

Drawing for track:

Bend Radii		1225	1225	1225	1225
Internal Angles		90.0	90.0	90.0	90.0
Facet Lengths		2450	2450	2450	2450

Angles & Facets Projections & Facets Strings LH Str

Bay Arc Ref: CP Interiors - 902818



LH

Length 1225

Inline

Angle 90.0

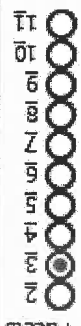

Facets

11
10
9
8
7
6
5
4
3
2

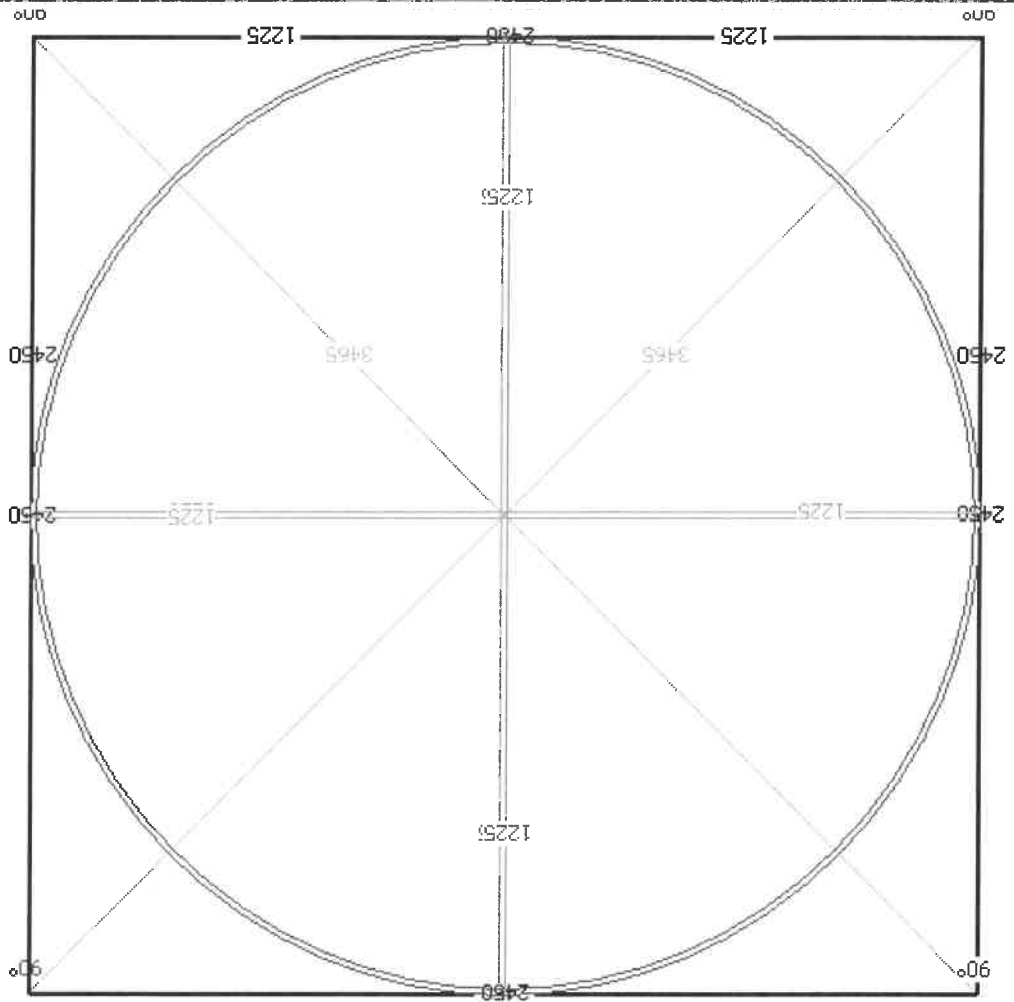

Using: 7605 R200 Inc Flush Endcap - based on straight Track Sizes

No Intermediate Pulley
Control Location(s) - Not Specified

Wall Length = 9800, Rail Length = 7808, Track Offset (Wall to back of Track) = -7mm (Returns -7mm)

Ref: CP Interiors - 902818

Using: 7605 R200 Inc Flush Endcap - based on straight Track Sizes

No Intermediate Pulley

Control Location(s) - Not Specified

Wall Length = 5900, Rail Length = 5380, Track Offset (Wall to back of Track) = -7mm

Ref: CP Interiors - 902818 - Track

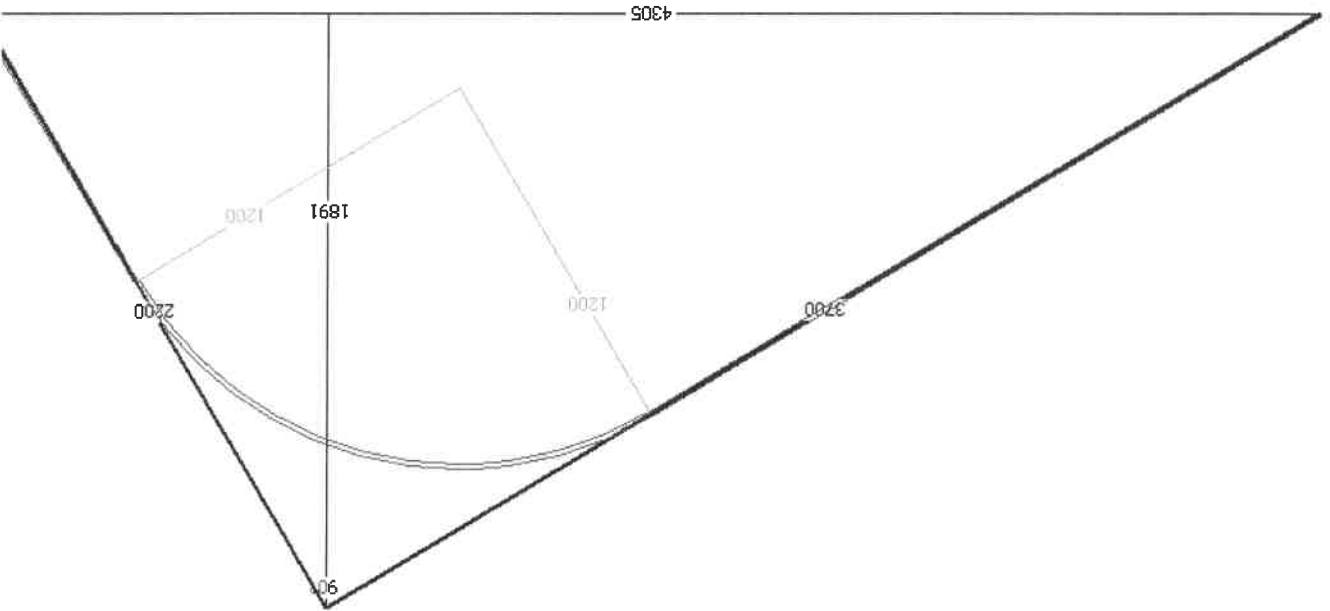

Bay	Arc	Ref: CP Interiors - 902818 - Track
Angles & Facets Projections & Facets Strings LH Strings & Facets RH Strings		
Facet Lengths	3700	2200
Internal Angles	90	
Bend Radii	1200	

Please let me know if all is good and I can release to production.

Kind regards,

Sally Brown

Senior Sales Co-Ordinator

—
Silent Gliss Ltd.
 Pyramid Business Park
 Pothole Lane
 Broadstairs
 Kent, CT10 2PT
 T: +44 (0)1843 874218 (direct)
 www.silentgliss.co.uk

From: Leena Taft <leena@cpinteriors.ie>

Sent: 28 October 2022 14:47

To: Sally Brown <SallyBrown@SilentGliss.co.uk>

ALL DIMENSIONS ARE TO BE CHECKED
ON SITE AND ANY DISCREPANCIES
REPORTED TO PF+A LTD

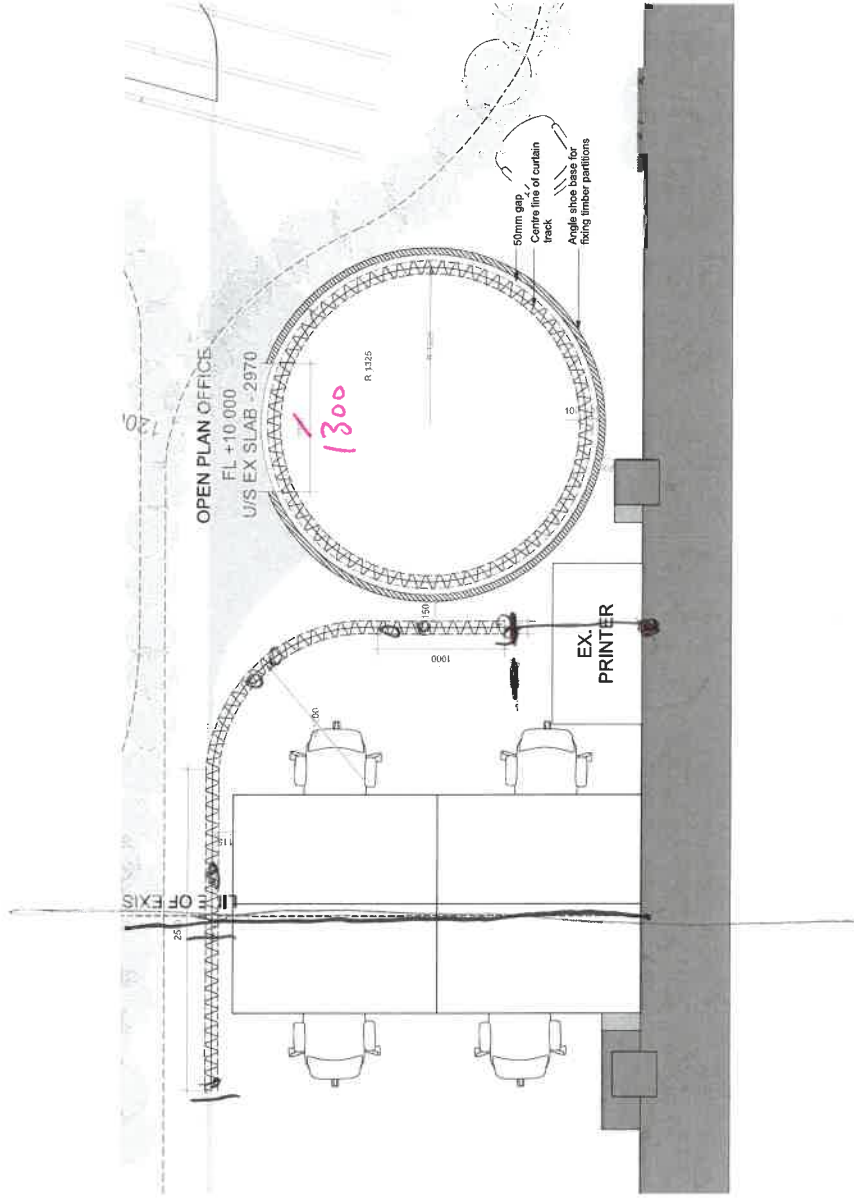

CONSTRUCTION

PROJECT NO: 7413-01 SK1
 PROJECT NAME: ANDIUM HOMES
 PROJECT ADDRESS: PROPOSED OFFICE FITOUT, ST HELENS STREET, WINDYBUSH, KZN 3600
 PROJECT NO: 7413-01 SK1
 DRAWING TITLE: PROPOSED DRAWINGS CURTAIN DIMENSIONS
 DATE: 09 OCT 2022
 DRAWN BY: HENRI M
 CHECKED BY: AG
 STATUS: FOR INFO/ APPROVAL FOR CONSTRUCTION

PF+A
 www.pfaarchitecture.co.za
 31-3103 16/16/16, GUY ST, LEWIS CONTEMPORARY ARCHITECTURE

CURTAIN DIMENSIONS 0 1 2 3 4 5 M

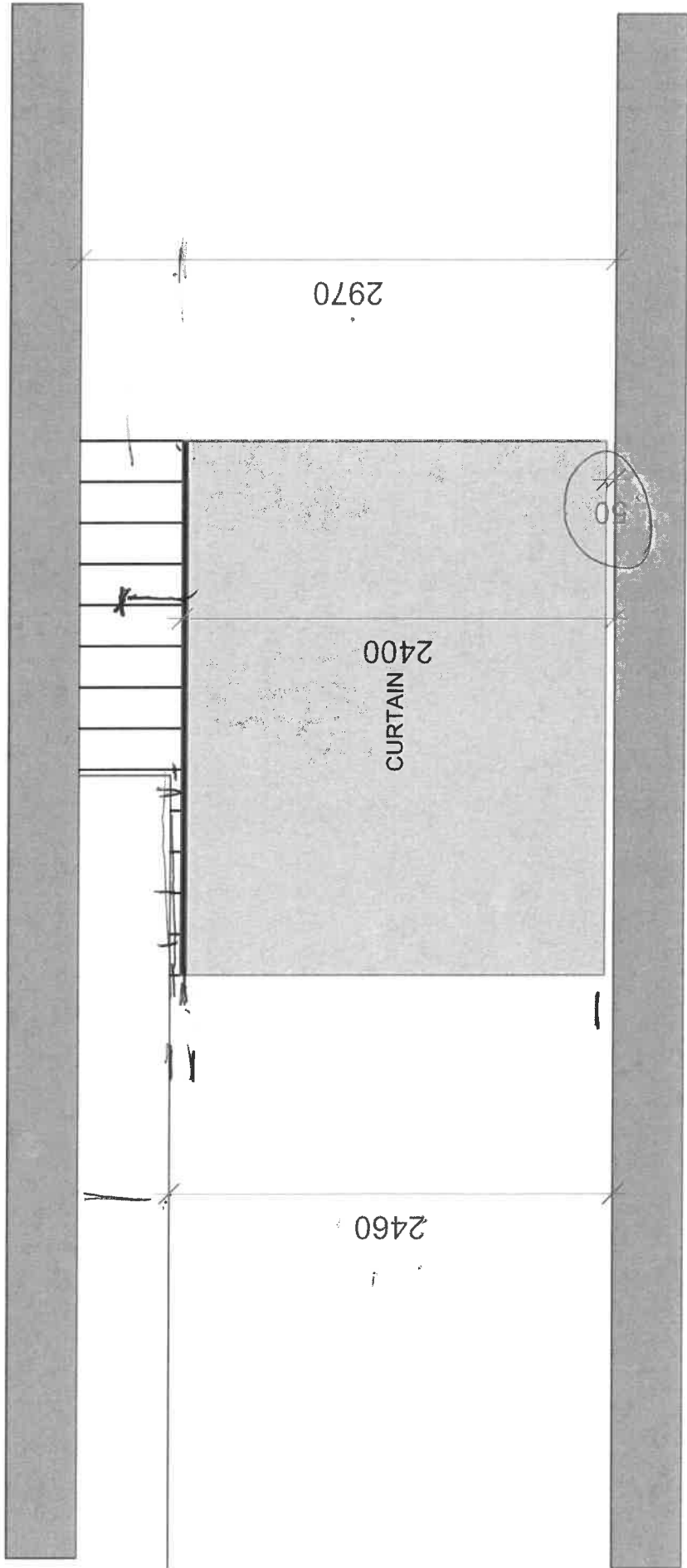

CURTAIN - ELEVATION

Bank