



Delivered by DSV Road Limited



SO1CI-BTR14

Handwritten signature

Deliver
CP INTERIORS
RUE DES PRESS TRADING EST
JE2 7QPST SAVIOUR
JERSEY

Contact charmain wilding
Phone +44 (0) 1255 242242

Page 2(2)

Phone +441534768141
Delv. --
Delv. Time
Ref 7509/23-12-1

Shipper
WEINOR
73 CORNHILL ROAD
LONDON
EC3V 3QQ

DELIVERY ADVICE

Consignee
CP INTERIORS
RUE DES PRESS TRADING EST
JE2 7QPST SAVIOUR
JERSEY

Date 2023-10-26
Reference SOJE33-0295 SO1CI-BTR14
Terms FREE ON BOARD
F.O.B.
JERSEY
Originating member EBOO

Coll. 2023-10-25/08:00-16:00
Unit.no DSV2004

Haulier TBA - UPDATE WITH CORRECT HAULIER
Reg.no DSV2004

RECEIVED

31 OCT 2023

SCANNED

*2x Box
Arrived
31-10-23*

DELIVERY ADVICE

Mann 6012932

*Williams
So 14812*

All business is transacted according to trading conditions that exclude or limit the liability of the company in certain circumstances. A copy of the relevant set of conditions will be supplied upon request.

7509/23-12-1

Marks & Nos	No.of	Pkg.	Contents	Weight	KG	Volume
	2	CLL	AWNINGS/PARTS	GW	125	0.184 CBM
				NW	125	
				EW	125	

DSV-EURPLL ____ pcs. RETURN TO DSV

ASSOCIATED FREIGHT SERVICES LTD **AFS**

INTERNATIONAL FREIGHT FORWARDERS

B7214

DELIVERY ADDRESS

CP INTERIORS C/O DSV ROAD LIMITED
10 BRUNEL WAY
SEGENSWORTH INDUSTRIAL ESTATE
FAREHAM, PO15 5TX
United Kingdom

Our reference 7509/23-12-1

Your reference 202789059

Date 23/10/2023

DELIVERY NOTE

SHIPPER:

WEINOR LIMITED
73 CORNHILL
LONDON
EC3 3QQ
United Kingdom

x

Special Instructions: GOODS IN UK FREE CIRCULATION

Terms of Shipment:

Number of Packages: 1 CARTONS 630

Gross Weight: 104.000

Description of Goods: AWNINGS/PARTS

202789059 x

RECIEVED:

DATE:

SIGNED:

PRINT:

PALLETS/CARTONS RECIEVED IN GOOD CONDITION

Subject to our terms and conditions, no claims for damages or shortages will be accepted unless made in writing within 7 days of delivery.

Unit 3E, Falcon Way off Central Way, Feltham, Middlesex TW14 0UQ

Tel: 020 8890 1066 - Fax: 020 8890 3398 - Email: info@afs-lon.co.uk - www.associatedfreight.co.uk

Registered office: Plaza Building, Lee High Road, London SE13 5PT - Registered in England No 2685525 - VAT No 584 4555 09

All goods are carried out in accordance with the latest standard trading conditions of BIFA

BIFA



ASSOCIATED FREIGHT SERVICES LTD **AFS**

INTERNATIONAL FREIGHT FORWARDERS

DELIVERY ADDRESS

CP INTERIORS C/O DSV ROAD LIMITED
10 BRUNEL WAY
SEGENSWORTH INDUSTRIAL ESTATE
FAREHAM, PO15 5TX
United Kingdom

Our reference 7509/23-12-1

Your reference 202789059

Date 23/10/2023

DELIVERY NOTE

SHIPPER:

WEINOR LIMITED
73 CORNHILL
LONDON
EC3 3QQ
United Kingdom

Special Instructions: GOODS IN UK FREE CIRCULATION

Terms of Shipment:

Number of Packages: 1 CARTONS 630

Gross Weight: 104.000

Description of Goods: AWNINGS/PARTS

202789059

RECIEVED:

DATE:

SIGNED:

PRINT:

PALLETS/CARTONS RECIEVED IN GOOD CONDITION

Subject to our terms and conditions, no claims for damages or shortages will be accepted unless made in writing within 7 days of delivery.

Unit 3E, Falcon Way off Central Way, Feltham, Middlesex TW14 0UQ

Tel: 020 8890 1066 - Fax: 020 8890 3398 - Email: info@afs-lon.co.uk - www.associatedfreight.co.uk

Registered office: Plaza Building, Lee High Road, London SE13 5PT - Registered in England No 2685525 - VAT No 584 4555 09

All goods are carried out in accordance with the latest standard trading conditions of BIFA



BRITISH INTERNATIONAL
FREIGHT ASSOCIATION
MEMBER SINCE 1992

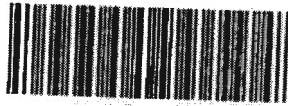

weinor Ltd 73 Cornhill EC3V 3QQ London

C P Interiors

Rue Des Pres Trading Estate

GB-JE2 7QN St Saviour Jersey



202789059

phone number: 0044-1534-768141
 customer: 165708
 representat. 654 Chris Spickett
 tel (representat.): 0044 (0) 7894443907

delivery note 223339979

Date of Print: 18.10.2023

delivery address

DSV Road Ltd
 (NO UPS)
 10 Brunel Way, Segensworth Industrial Estate
 GB-PO15 5TX Hampshire, Fareham

England

NO UPS

sales order no.: 202789059
 order date: 01.09.2023
 reference: Williams
 Your order no.: SO14812

pos quantity article code

2 1 1883 Opal Design II

expected delivery date : 23.10.2023
 Number of packages : 1
 weight : 104,44 kg
 Maximum package weight : 104,44 kg
 measurement of awning : 600X300

mode of dispatch UK export

date _____ signature _____

delivery exw Cologne
 weight 104,44 kg
 package 1 Stk.

weinor Ltd
 73 Cornhill
 GB-EC3V 3QQ London
 weinor.com

Managing Director,
 Thilo Weiermann
 General partner
 Weinor Beteiligungs-GmbH
 Köln

VAT no.: 355 238116
 Company no.: 12193066
 UTR no.: 93431 24684
 EOR no.: GB335228116000

Domestic transfers:
 Commerzbank London
 Sort Code: 406201
 Account Number: 307 537 10

International transfers:
 Commerzbank London
 IBAN: GB51 0830 0000 0000 0000 0000
 Swift: MIDLGB22 a/c COBAGE2X



weinor Ltd 73 Cornhill EC3V 3QQ London

C P Interiors

Rue Des Pres Trading Estate

GB-JE2 7QN St Saviour Jersey

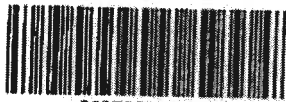

202789059

phone number: 0044-1534-768141
 customer: 165708
 representat. 654 Chris Spickett
 tel (representat.): 0044 (0) 7894443907

delivery note 223339979

Date of Print: 18.10.2023

delivery address

DSV Road Ltd
 (NO UPS)
 10 Brunel Way, Segensworth Industrial Estate
 GB-PO15 5TX Hampshire, Fareham

England

NO UPS

sales order no.: 202789059
 order date: 01.09.2023
 reference: Williams
 Your order no.: SO14812

pos	quantity	article code	
2	1	1883	Opal Design II

expected delivery date : 23.10.2023
 Number of packages : 1
 weight : 104,44 kg
 Maximum package weight : 104,44 kg
 measurement of awning : 600X300

mode of dispatch UK export

date _____ signature _____

delivery exw Cologne
 weight 104,44 kg
 package 1 Stk.

weinor Ltd
 73 Cornhill
 GB EC3V 3QQ London
 weinor.com

Managing Director:
 Thilo Weiermann
 General partner
 Weinor Beteiligungs-GmbH
 Köln

VAT no.: 335 2381 16
 Company no.: 1219066
 UTR no.: 3347124084
 EORI no.: GB335238116000

Domestic transfers:
 Commerzbank London
 Sort Code: 406201
 Account Number: 307 53710

International transfers:
 Commerzbank London
 IBAN: GR51 COBA 4062 0130 7327 10
 Swift: MIDLGB22 a/c COBAGB2X

ASSOCIATED FREIGHT SERVICES LTD **AFS**

INTERNATIONAL FREIGHT FORWARDERS

DELIVERY ADDRESS

CP INTERIORS C/O DSV ROAD LIMITED
10 BRUNEL WAY
SEGENSWORTH INDUSTRIAL ESTATE
FAREHAM, PO15 5TX
United Kingdom

Our reference 7505/23-44-1

Your reference 202795857

Date 18/10/2023

DELIVERY NOTE

SHIPPER:

WEINOR LIMITED
73 CORNHILL
LONDON
EC3 3QQ
United Kingdom

X

Special Instructions: GOODS IN UK FREE CIRCULATION

Terms of Shipment:

Number of Packages: 1 CARTONS 0

Gross Weight: 6.000

Description of Goods: AWNINGS/PARTS

202795857

RECIEVED:

DATE:

SIGNED:

PRINT:

PALLETS/CARTONS RECIEVED IN GOOD CONDITION

Subject to our terms and conditions, no claims for damages or shortages will be accepted unless made in writing within 7 days of delivery.

Unit 3E, Falcon Way off Central Way, Feltham, Middlesex TW14 0UQ

Tel: 020 8890 1066 - Fax: 020 8890 3398 - Email: info@afs-lon.co.uk - www.associatedfreight.co.uk

Registered office: Plaza Building, Lee High Road, London SE13 5PT - Registered in England No 2685525 - VAT No 584 4555 09

All goods are carried out in accordance with the latest standard trading conditions of BIFA



BRITISH INTERNATIONAL
FREIGHT ASSOCIATION
INCORPORATED IN GREAT BRITAIN

ASSOCIATED FREIGHT SERVICES LTD **AFS**

I N T E R N A T I O N A L F R E I G H T F O R W A R D E R S

DELIVERY ADDRESS

CP INTERIORS C/O DSV ROAD LIMITED
10 BRUNEL WAY
SEGENSWORTH INDUSTRIAL ESTATE
FAREHAM, PO15 5TX
United Kingdom

Our reference 7505/23-44-1

Your reference 202795857

Date 18/10/2023

DELIVERY NOTE

SHIPPER:

WEINOR LIMITED
73 CORNHILL
LONDON
EC3 3QQ
United Kingdom

Special Instructions: GOODS IN UK FREE CIRCULATION

Terms of Shipment:

Number of Packages: 1 CARTONS 0

Gross Weight: 6.000

Description of Goods: AWNINGS/PARTS
202795857

RECIEVED:

DATE:

SIGNED:

PRINT:

PALLETS/CARTONS RECIEVED IN GOOD CONDITION

Subject to our terms and conditions, no claims for damages or shortages will be accepted unless made in writing within 7 days of delivery.

Unit 3E, Falcon Way off Central Way, Feltham, Middlesex TW14 0UQ

Tel: 020 8890 1066 - Fax: 020 8890 3398 - Email: info@afs-ion.co.uk - www.associatedfreight.co.uk

Registered office: Plaza Building, Lee High Road, London SE13 5PT - Registered in England No 2685525 - VAT No 584 4555 09

All goods are carried out in accordance with the latest standard trading conditions of BIFA



BRITISH INTERNATIONAL
FREIGHT ASSOCIATION

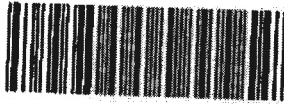

weinor Ltd 73 Cornhill EC3V 3QQ London

delivery note 223338260

Date of Print: 16.10.2023

C P Interiors

delivery address

DSV Road Ltd
(NO UPS)
10 Brunel Way, Segensworth Industrial Estate
GB-PO15 5TX Hampshire, Fareham

Rue Des Pres Trading Estate

GB-JE2 7QN St Saviour Jersey

England

NO UPS



202795857

phone number: 0044-1534-768141
customer: 165708
representat. 654 Chris Spickett
tel (representat.): 0044 (0) 7894443907

sales order no.: 202795857

order date: 05.10.2023

reference: MANN

Your order no.:

pos	quantity	article code
2	5	121206-0194 Tiger-Pulver colour:29/10797 5 KG

expected delivery date : 23.10.2023
Customer tour : 430
sales unit : Kilogramm UK export

mode of dispatch UK export

date _____ signature _____

delivery exw Cologne
weight 6 kg
package 1 Stk.

weinor Ltd
73 Cornhill
GB-EC3V 3QQ London
weinor.com

Managing Director:
Thilo Weiermann
General partner
Weinor Beteiligungs-GmbH
Kc/n

VAT no.: 335 238116
Company no.: 12193066
UTR no.: 3343124084
ECRi no.: GB335238116000

Domestic transfers:
Commerzbank London
Sort Code: 406201
Account Number: 307 537 19

International transfers:
Commerzbank London
IBAN: GB51 0831 0000 0000 0000 0000
Swift: MIDLGB22 h/c COEAGB2K

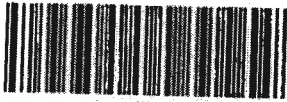

weinor ltd 73 Cornhill EC9P 3QQ London

C P Interiors

Rue Des Pres Trading Estate

GB-JE2 7QN St Saviour Jersey



202795857

phone number: 0044-1534-768141
 customer: 165708
 representat: 654 Chris Spickett
 tel (representat.): 0044 (0) 7894443907

delivery note 223338260

Date of Print: 16.10.2023

delivery address

DSV Road Ltd
 (NO UPS)
 10 Brunel Way, Segensworth Industrial Estate
 GB-PO15 5TX Hampshire, Fareham

England

NO UPS

sales order no.: 202795857

order date: 05.10.2023

reference: MANN

Your order no.:

pos	quantity	article code
2	5	121206-0194 Tiger-Pulver colour:29/10797

5 KG

expected delivery date : 23.10.2023
 Customer tour : 430 UK export
 sales unit : Kilogramm

mode of dispatch UK export

date _____ signature _____

delivery exw Cologne

weight 6 kg

package 1 Stk.

weinor ltd
 73 Cornhill
 GB EC9P 3QQ London
 weinor.com

Managing Director
 Thilo Weiermann
 General partner
 Weinor Beteiligungs-GmbH
 KfzR

VAT no: 335 2381 16
 Company no: 1193066
 UTR no: 3431 24084
 EOB no: GB335238116000

Domestic transfers:
 Commerzbank London
 Sort Code: 406201
 Account Number: 307 537 10

International transfers:
 Commerzbank London
 IBAN: GB31 0804 0002 0130 7537 10
 Swift: MIDLGB22 aka COSAGB2X

Configuration details

weinor Ltd 73 Cornhill EC3V 3QQ London

C P Interiors

Rue Des Pres Trading Estate
GB-JE2 7QN St Saviour Jersey

reference: MANN
 Your order no.:
 weinor customernumber: 165708
 creation Date: 05.10.2023
 weinor pers. in charge: William Abbott
 phone / fax number: +49-221-59709-472
 representat.: Chris Spickett
 tel (representat.): 0044 (0) 7894443907

Powder for flashings

pos	quantity	article	price
-----	----------	---------	-------

Dear Customer,

We herewith confirm your order based on the dimensions specified by you.

IMPORTANT: With immediate effect, you can technically release your orders from the weinor E-shop yourself and will be provided with a delivery date immediately. Moreover, it is possible to stop orders in the weinor E-shop independently up to a specific production point.

Trust in fast and safe in the future: Orders possible via the weinor E-shop are processed faster. Additionally, errors are virtually ruled out. The system instantly checks and confirms your configuration for technical feasibility.

Please observe that we can only name a likely delivery date after your final release. Each change requires re-engineering, thus extending the delivery period.

Please also take into account that changes to an order after release cause costs which we may have to pass on to you.

Please send the release to our telefax no.: +49 221 59709-83602 or by E-mail: freigabe@weinor.de

Many thanks!

Your APPROVAL:
 (Signature) (Date)

2	5	weinor Tiger-Pulver Farbe: 29/10797	156,00
---	---	--	--------

5 KG

Anticipated delivery	: 23.10.2023	
customer route	: 430 UK export	
price per unit	: 31,2 GBP / Kilogramm	31,20

weinor Ltd
73 Cornhill
GB-EC3V 3QQ London
weinor.com

Managing Director:
Thilo Weiermann
General partner:
Weinor Beteiligungs-GmbH
Köln

VAT no.: 335 2381 16
Company no.: 12193066
UTR no.: 33431 24084
EORI no.: GB335238116000

Domestic transfers:
Commerzbank London
Sort Code: 406201
Account Number: 307 537 10
International transfers:
Commerzbank London
IBAN: GB51 COBA 4062 0130 7537 10
Swift: MIDLGB22 a/c COBAGB2X

Configuration details

weinor Ltd 73 Cornhill EC3V 3QQ London

Page 2 of 2

customer:	165708	reference:	MANN		
pos	quantity	article			price
sales unit		: Kilogramm			
		value of goods	discount amount / %		net
		156,00	62,40 / 40,00		93,60
999	1	weinor Netto-Materialkostenzuschlag			0,00
price per unit		: 0			
		value of goods	discount amount / %		net
		0,00	0,00 / 0,00		0,00
value of goods GBP	discount amount	net GBP	VAT (0 %)	Total GBP	
156,00	62,40	93,60	0,00	93,60	

Configuration details



Awnings Patjo roofs Glasasen®

C P Interiors

weinor Ltd 73 Cornhill EC3V 3QQ London

Rue Des Pres Trading Estate
GB-JE2 7QN St Saviour Jersey

sales order no.: 202656236
reference: Mann sempra SO12932
Your order no.: 165708
weinor customer number:

creation Date: 18.03.2022
weinor pers. in charge: William Abbott
phone / fax number: +49-221-59709-472
representat.: Chris Spickett
tel (representat.): 0044 (0) 7894443907

pos	quantity	article
-----	----------	---------

O.C. version 2:
We have added wall connection profiles for pos 3.
HD receivers will be sent in a separate order 202657066

1	1	weinor Terrazza
---	---	-----------------

Roofsystem

: Terrazza L Sempra
: ATTENTION! Element is supplied without glass!
: 750 N/m²
Permissible snow-bearing load
version gutter
Gutter 220 with VertTex II
: Yes, for round VertTex II
: gutter 220x113
Gutter 220 with VertTex II
: Shall the backside of the gutter
220 be prepared for UBE to be
fitted behind the posts / gutter ?
External dimensions
: 6700mm x 3885mm Depth: wall connection profile up to INSIDE edge
of post
: 2150 mm
: 3164 mm
Bottom edge gutter (mm)
Bottom edge connection to wall
(mm)
: 3359 mm
Top edge connection to wall (mm)
Pitch of roof [°]
: 11,84 °
: info
Basic colour
Covering
Information about roofing
basic element
Seals
Seals
: 101 Type A pent roof
: silicone-containing seals
: No wall connection on left
: No wall connection on right
Connection to wall left?
Connection to wall right?

weinor Ltd

73 Cornhill
GB-EC3V 3QQ London

weinor.com

Managing Director:

Thilo Weiermann

General partner:

Weinor Beteiligungs-GmbH

Köln

VAT no.: 335 2381 16

Company no.: 12193066

UTR no.: 33431 24084

FORI no.: GB335238116000

Domestic transfers:

Commerzbank London

Sort Code: 406201

Account Number: 307 537 10

International transfers:

Commerzbank London

IBAN: GB51 COBA 4062 0130 7537 10

Swift: MIDLGB22 a/c COBAGB2X

Configuration details

weinor Ltd 73 Cornhill EC3V 3QQ London

customer: 165708 reference: Mann sempra

Page 2 of 16

pos	quantity	article
		Static adjustment of the roof for glazing element under side roof -beams on left and / or right? : Yes, statics for GEs (w50-c lite side element)
		bottom edge of GE (trapeze) on the left side : 60mm above bottom edge gutter
		bottom edge of GE (trapeze) on the right side : 60mm above bottom edge gutter
		Roof support type, inner roof supports : 150 roof girder without steel
		Roof support type, outer roof supports left : 150 roof girder with steel
		Roof support type, outer roof supports right : 150 roof girder with steel
		Transom over all roof panels : yes
		Further transoms across all roof sections : no
		Number of additional rafter : 1 Additional rafter
		Axial dimension rafter : 826,8 mm
		version post : square post
		Post type left : Post outside
		Post type right : Post outside
		Number of posts : 3 Piece
		Post position on the left : 60,5 mm
		Recommended position of centre post : 3350 1st centre post from outer left-hand edge!
		Post position on the right : 60,5 mm
		Max. distance between posts : 4750 mm with no steel in gutter
		Length of post : 2600 mm
		Post attachment left : 196x196x310 small aluminium base
		Post attachment middle : 116x196 post plate
		Post attachment right : 196x196x310 small aluminium base
		Aluminium base plate for post : 2 Piece
		Number of post base plates 116x196 : 1 Piece
		Number of caps for post plate : 2 Piece
		Number of caps for post plate : 1 Piece
		Drain on left side? : Drain through the left post
		Drain on right side? : Drain through the right post

Configuration details

weinor Ltd 73 Cornhill EC3V 3QQ London

customer: 165708 reference: Mann sempra

Page 3 of 16

pos	quantity	article
		Number of drains through posts incl. down pipes with bends 87° : 2 incl. downspout and 87° elbow
		Leaf protection screen (no extra cost) : Leaf guard same width as roof
		Cover profile to protect the front glass edges : 114926 Angle cover profile 15x20
		Provision for fitting Sottezza. : 12 Piece
		Sottezza-Type : Sottezza stretch/optistretch (alle variants)
		Substructure elements available (from outside) : UBB glazing elements on both sides
		Projection Sottezza [mm] : 3897,4 mm
		The specified length does account for 40 mm spacing from the wall or 20 mm from the guttering.
		Distance from Sottezza to the wall : 40 mm
		Distance from Sottezza to the gutter : 20 mm
		Projection of WGM : 4089 mm
		The specified length does account for 20 mm and an overhang on the end of rafter 30 mm from the guttering.
		Left-hand wall : Rectangular pipe 100x30 Rectangular pipe 50x30
		Right-hand wall : Rectangular pipe 100x30 Rectangular pipe 50x30
		Exclusively for weinor-eshop orders, we further simplified installation: various assemblies are delivered in a pre-assembled state or are blocked out for installation!
		: 24,86 m ²
		Note glass area : The glass surface concern only the roof.
		Weight [kg] : 509,2 kg

Configuration details

weinor Ltd 73 Cornhill EC3V 3QQ London

customer: 165708

reference: Mann sempra

Page 4 of 16

pos	quantity	article
2	1	weinor Side element LITE w50-c

.	: ATTENTION! Element is supplied without glass!
Product use	: private house
Frame profile	: blind frame section 105 w50-c bottom blind frame section 35 w50-c top
Width of element [mm]	: 3845 mm
Incline	: 11,84 Degree(s)
Installation side (as seen from inside)	: right
Number of vertical glass panels	: four parts
Prepared for	: prepared for 6mm (for cold use)
Wind load bracket	: yes, with wind load profile
Basic colour	: WT029/10797 Approx. RAL 9010
gap seal	: Gap seals for 6 mm glass, length 2000 mm
Cardboard container	: edges reinforcement

Configuration details

weinor Ltd 73 Cornhill EC3V 3QQ London

customer: 165708 reference: Mann sempra

Page 5 of 16

pos	quantity	article
-----	----------	---------

3	1	weinor w17 easy - the full glass sliding door
---	---	---

.	: ATTENTION! Element is supplied with glass!
Product use	: private house
Width of element [mm]	: 3845 X 2210
type of floor rail	: standard floor rail with CleanCase
CleanCase left (from inside)	: yes
CleanCase right (from inside)	: yes
Selection of leaves + tracks	: 4-track with 4 leaves
Position of active leaf?	: left, as seen from inside
Direction of opening	: sliding to the right
Glazing	: 10 mm toughened safety glass, clear
Soft-Closing-System	: Soft-Closing-System standard
handling	: cup pull handle with A4 stainless steel attachment
leaf actuator	: leaf actuator only closing in sliding direction
Locking mechanism on inside, on bottom glass retainer profile	: Standard: Glass retainer profile, pre-drilled
Height of knob from bottom edge of guide track (mm)	: 1050 mm
Basic colour	: WT029/10797 Approx. RAL 9010
wall connection profile left	: yes
wall connection profile right	: yes
brush seal	: 3 x Brush profile transparent for 10 mm glass, length 2800 mm
Note	: Despite brush and, where applicable, gap sealing the w17 easy is neither totally windproof nor water-proof against driving raining
Cardboard container	: edges reinforcement
packaging	: Export packaging/ glass pallet
extra charge glass pallet	: 2 x wooden pallet
weight	: 252,86 kg

Configuration details

weinor Ltd 73 Cornhill EC3V 3QQ London

customer: 165708 reference: Mann sempra

Page 6 of 16

pos	quantity	article
-----	----------	---------

4	1	weinor Side element LITE w50-c
---	---	--------------------------------

.	: ATTENTION! Element is supplied without glass!
Product use	: private house
Frame profile	: blind frame section 105 w50-c bottom blind frame section 35 w50-c top
Width of element [mm]	: 3845 mm
Incline	: 11,84 Degree(s)
Installation side (as seen from inside)	: left
Number of vertical glass panels	: four parts
Prepared for	: prepared for 6mm (for cold use)
Wind load bracket	: yes, with wind load profile
Basic colour	: WT029/10797 Approx. RAL 9010
gap seal	: Gap seals for 6 mm glass, length 2000 mm
Cardboard container	: edges reinforcement

Configuration details

weinor Ltd 73 Cornhill EC3V 3QQ London

customer: 165708 reference: Mann sempra

Page 7 of 16

pos	quantity	article
-----	----------	---------

5	1	weinor w17 easy - the full glass sliding door
---	---	---

.	: ATTENTION! Element is supplied with glass!
Product use	: private house
Width of element [mm]	: 3845 X 2210
type of floor rail	: standard floor rail with CleanCase
CleanCase left (from inside)	: yes
CleanCase right (from inside)	: yes
Selection of leaves + tracks	: 4-track with 4 leaves
Position of active leaf?	: right, as seen from inside
Direction of opening	: sliding to the left
Glazing	: 10 mm toughened safety glass, clear
Soft-Closing-System	: Soft-Closing-System standard
handling	: lock case and hung bolt
side of the handling	: handling on both sides
Operation lockcase	: doorknob inside and outside
type of knob	: Standard-knob; same-coloured as the construction
leaf actuator	: leaf actuator opening and closing in sliding direction
Version of profile cylinder?	: Standard by price list (With different key)
Height of lock from bottom edge of guide track	: 1050 up to centre of profile cylinder (in mm)
Basic colour	: WT029/10797 Approx. RAL 9010
wall connection profile left	: yes
wall connection profile right	: yes
brush seal	: 3 x Brush profile transparent for 10 mm glass, length 2800 mm
Note	: Despite brush and, where applicable, gap sealing the w17 easy is neither totally windproof nor water-proof against driving raining
Cardboard container	: edges reinforcement
packaging	: Export packaging/ glass pallet
weight	: 181,74 kg

Configuration details

weinor Ltd 73 Cornhill EC3V 3QQ London

customer: 165708 reference: Mann sempra Page 8 of 16

pos	quantity	article
-----	----------	---------

6	1	weinor w17 easy - the full glass sliding door
---	---	---

.	: ATTENTION! Element is supplied with glass!
Product use	: private house
Width of element [mm]	: 3174 X 2150
type of floor rail	: standard floor rail with CleanCase
CleanCase left (from inside)	: yes
CleanCase right (from inside)	: yes
Selection of leaves + tracks	: 4-track with 4 leaves
Position of active leaf?	: right, as seen from inside
Direction of opening	: sliding to the left
Glazing	: 10 mm toughened safety glass, clear
Soft-Closing-System	: Soft-Closing-System standard
handling	: cup pull handle with A4 stainless steel attachment
leaf actuator	: leaf actuator only closing in sliding direction
Locking mechanism on inside, on bottom glass retainer profile	: Standard: Glass retainer profile, pre-drilled
Height of knob from bottom edge of guide track (mm)	: 1050 mm
Basic colour	: WT029/10797 Approx. RAL 9010
wall connection profile left	: yes
wall connection profile right	: yes
brush seal	: 3 x Brush profile transparent for 10 mm glass, length 2800 mm
Note	: Despite brush and, where applicable, gap sealing the w17 easy is neither totally windproof nor water-proof against driving raining
Cardboard container	: edges reinforcement
packaging	: Export packaging/ glass pallet
weight	: 196,02 kg

Configuration details

weinor Ltd 73 Cornhill EC3V 3QQ London

customer: 165708 reference: Mann sempra

Page 9 of 16

pos	quantity	article
-----	----------	---------

7	1	weinor w17 easy - the full glass sliding door
---	---	---

.	: ATTENTION! Element is supplied with glass!
Product use	: private house
Width of element [mm]	: 3174 X 2150
type of floor rail	: standard floor rail with CleanCase
CleanCase left (from inside)	: yes
CleanCase right (from inside)	: yes
Selection of leaves + tracks	: 4-track with 4 leaves
Position of active leaf?	: left, as seen from inside
Direction of opening	: sliding to the right
Glazing	: 10 mm toughened safety glass, clear
Soft-Closing-System	: Soft-Closing-System standard
handling	: cup pull handle with A4 stainless steel attachment
leaf actuator	: leaf actuator only closing in sliding direction
Locking mechanism on inside, on bottom glass retainer profile	: Standard: Glass retainer profile, pre-drilled
Height of knob from bottom edge of guide track (mm)	: 1050 mm
Basic colour	: WT029/10797 Approx. RAL 9010
wall connection profile left	: yes
wall connection profile right	: yes
brush seal	: 3 x Brush profile transparent for 10 mm glass, length 2800 mm
Note	: Despite brush and, where applicable, gap sealing the w17 easy is neither totally windproof nor water-proof against driving raining
Cardboard container	: edges reinforcement
packaging	: Export packaging/ glass pallet
weight	: 208,26 kg

Configuration details

weinor Ltd 73 Cornhill EC3V 3QQ London

customer: 165708 reference: Mann sempra

Page 10 of 16

pos	quantity	article
-----	----------	---------

8	1	weinor Sottezza II OptiStretch
---	---	--------------------------------

Product use	: private house
Anticipated delivery	: 27.06.2022
Sales order Terrazza	: 202656236
Posn. of the sales order for Terrazza	: 1
Number of units	: single unit
width Terrazza [mm]	: 6700 mm
Distance centre to centre field	: 3258 mm
Width of cassette total [mm]	: 3294 mm
Projection [mm]	: 3897,4 mm
Basic colour	: WT029/10797 Approx. RAL 9010
Cable clips along the back of the cassette	: without cable clips along the back of the cassette
type of control	: motor (Becker)
Side of control (seen from the front)	: right
with remote control BiConnect	: Yes! Please remind the separate order!
Information on BiConnect	: The BiConnect has been done in 202656236 position 10!
Type of engine	:
Side channel bracket	: 4 Piece
brackets top plate	: 2 Piece
real-design	: WE3-882 my collections
colour of thread Saba	: RAL 7001 Silver grey
Cardboard container	: edges reinforcement
weight	: 72,52 kg

Configuration details

weinor Ltd 73 Cornhill EC3V 3QQ London

customer: 165708 reference: Mann sempra

Page 11 of 16

pos	quantity	article
-----	----------	---------

9	1	weinor Sottezza II OptiStretch
---	---	--------------------------------

Product use	: private house
Anticipated delivery	: 27.06.2022
Sales order Terrazza	: 202656236
Posn. of the sales order for Terrazza	: 1
Number of units	: single unit
width Terrazza [mm]	: 6700 mm
Distance centre to centre field	: 3258 mm
Width of cassette total [mm]	: 3294 mm
Projection [mm]	: 3897,4 mm
Basic colour	: WT029/10797 Approx. RAL 9010
Cable clips along the back of the cassette	: without cable clips along the back of the cassette
type of control	: motor (Becker)
Side of control (seen from the front)	: left
with remote control BiConnect	: Yes! Please remind the separate order!
Information on BiConnect	: The BiConnect has been done in 202656236 position 10!
Type of engine	:
Side channel bracket	: 4 Piece
brackets top plate	: 2 Piece
real-design	: WE3-882 my collections
colour of thread Saba	: RAL 7001 Silver grey
Cardboard container	: edges reinforcement
weight	: 71,32 kg

Configuration details

weinor Ltd 73 Cornhill EC3V 3QQ London

customer: 165708 reference: Mann sempra

Page 12 of 16

pos	quantity	article
-----	----------	---------

10	1	weinor BiConnect
-----------	----------	-------------------------

deliver BiConnect separate?	: No; supply receiver and handheld remote control with awning
shipment info	: The pre set receivers (except LED) and the handset will be packed with contract number 202656236 pos 8!
Receiver for motor/ control	: 2 BiRec MA, basic : BiConnect BiEasy 5M (black version)
learned on channel 1	: BiRec MA-K, basic for order 202656236/8: Sothezza II OptiStretch engine right
learned on channel 2	: BiRec MA-K, basic for order 202656236/9: Sothezza II OptiStretch engine left

11	2	weinor Tempura Quadra
-----------	----------	------------------------------

Product use	: private house
Utilisation	: universal
width [mm]	: 400 mm
Basic colour	: WT029/10797 Approx. RAL 9010
operation	: Standard
access	: Hirschmann plug (standard)
weight	: 4,4 kg

999	1	weinor Netto-Materialkostenzuschlag
------------	----------	--

Configuration details

weinor Ltd 73 Cornhill EC3V 3QQ London

customer: 165708

reference: Mann sempra

Page 13 of 16

isometric view

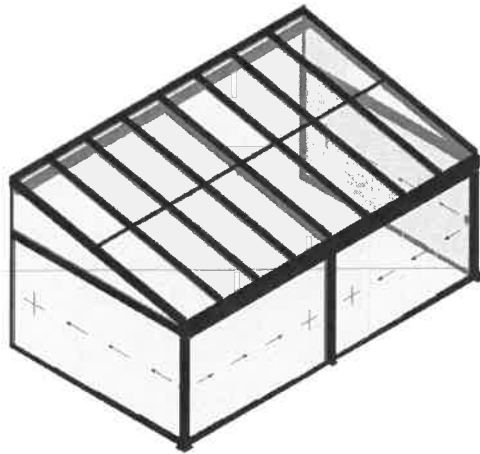

top view

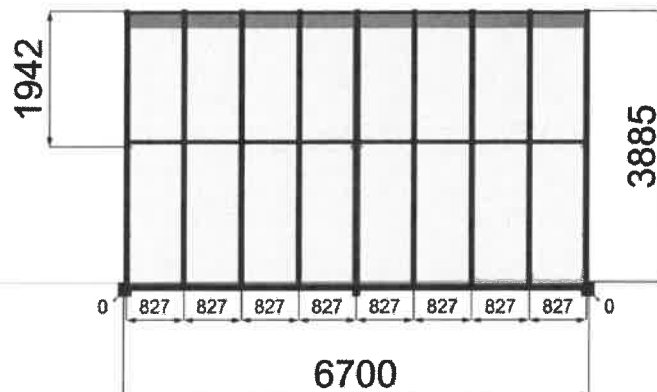

weinor Ltd
73 Cornhill
GB-EC3V 3QQ London
weinor.com

Managing Director:
Thilo Weiermann
General partner:
Weinor Beteiligungs-GmbH
Köln

VAT no.: 335 2381 16
Company no.: 12193066
UTR no.: 33431 24084
EORI no.: GB335238116000

Domestic transfers:
Commerzbank London
Sort Code: 406201
Account Number: 307 537 10

International transfers:
Commerzbank London
IBAN: GB51 COBA 4062 0130 7537 10
Swift: MIDLGB22 a/c COBAGB2X

Configuration details

weinor Ltd 73 Cornhill EC3V 3QQ London

customer: 165708 reference: Mann sempra

Page 14 of 16

front view

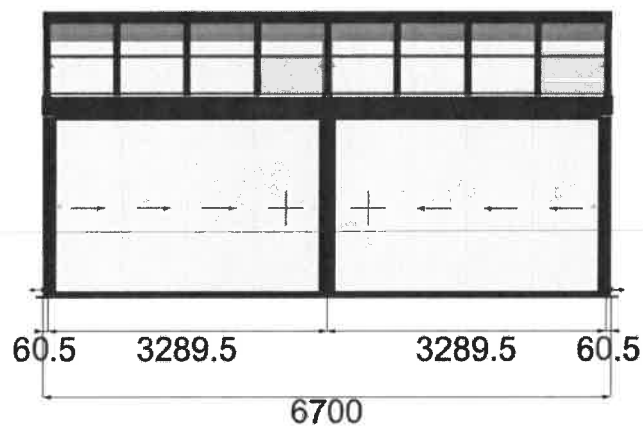

side view left

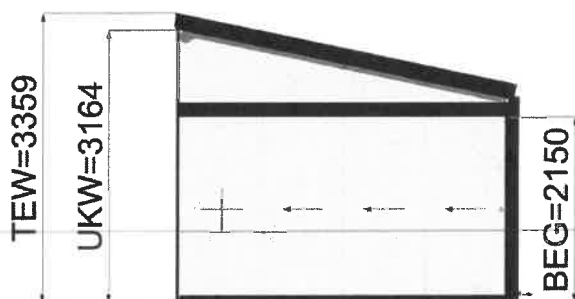

side view right

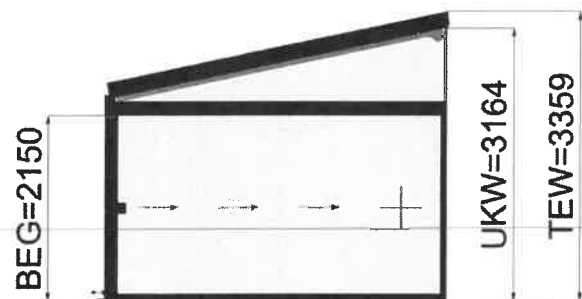

Configuration details

weinor Ltd 73 Cornhill EC3V 3QQ London

customer: 165708 reference: Mann sempra

Page 15 of 16

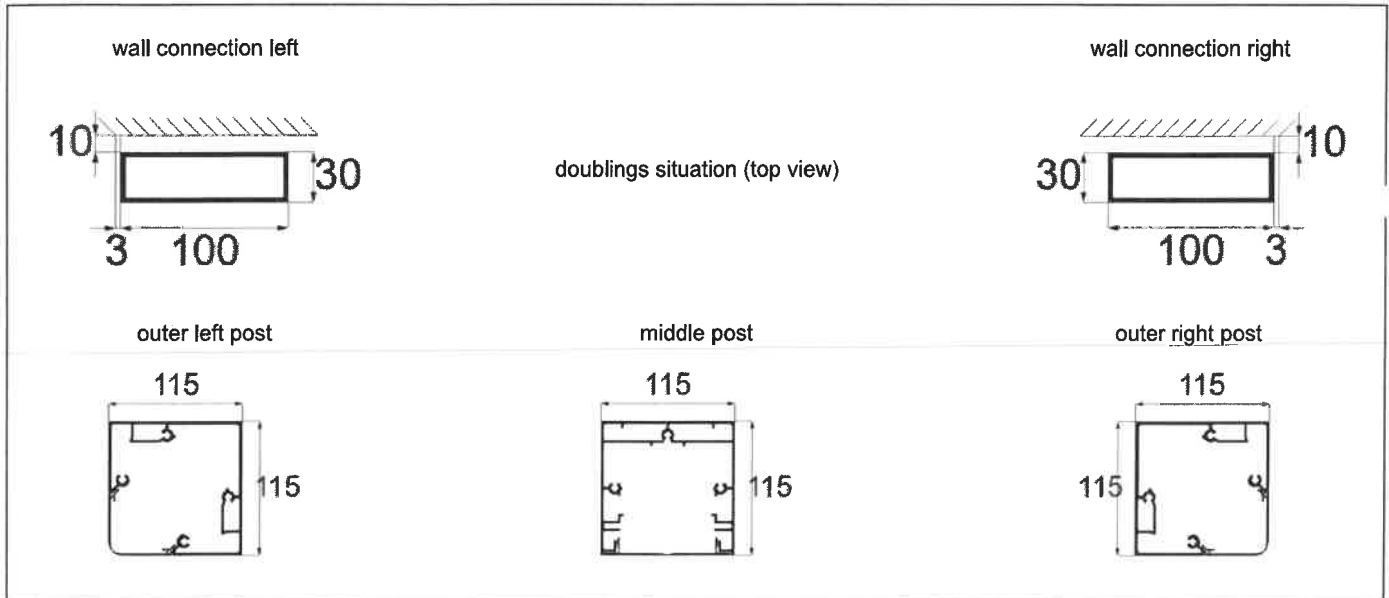

Configuration details

weinor Ltd 73 Cornhill EC3V 3QQ London

customer: 165708 reference: Mann sopra

Page 16 of 16

Note, these glass dimensions are not part of the order confirmation and are only part of the configuration from 20.7.2022.

Glass Dimensions

Position	1	Terrazza	prepared for 10mm LSG		
quantity	form		Width	Height left	Height right
16	rectangle		782	1987	1987
Position	2	Side element LITE w50-c	prepared for 6mm (for cold use)		
quantity	form		Width	Height left	Height right
1	trapezium right		955	57	257
1	trapezium right		955	258	459
1	trapezium right		955	460	660
1	trapezium right		955	661	861
Position	4	Side element LITE w50-c	prepared for 6mm (for cold use)		
quantity	form		Width	Height left	Height right
1	trapezium left		955	861	661
1	trapezium left		955	660	460
1	trapezium left		955	459	258
1	trapezium left		955	257	57

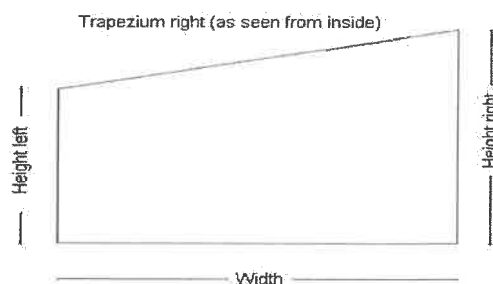
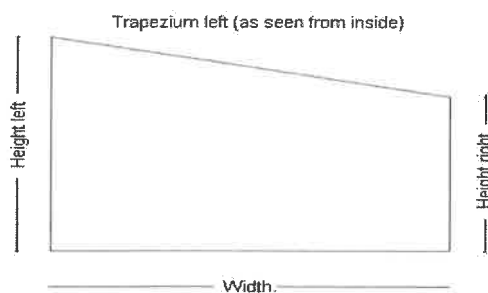

+ Bungalow Brackets
from Bardec.

weinor Ltd 73 Cornhill EC3V 3QQ London

C P Interiors

**Rue Des Pres Trading Estate
GB-JE2 7QN St Saviour Jersey**

delivery address

DSV Road Ltd
(NO UPS)
10 Brunel Way, Segensworth Industrial Estate
GB-PO15 5TX Hampshire, Fareham
NO UPS

ORDER CONFIRMATION (release 1)

sales order no.: 202789059 of 01.09.2023
customer: 165708
reference: Williams
Your order no.: SO14812
contact person: William Abbott
E-Mail: WAbbott@weinor.de
phone number: +49-221-59709-472
representat.: 654 Chris Spickett
tel (representat.): 0044 (0) 7894443907

pos — quantity — article code

pos	quantity	article code		
2	1,00	1883	Opal Design II	
			Anticipated delivery	: 23.10.2023
			Product use	: private house
			width [cm]	: 600 cm
			Projection [cm]	: 300 cm 3.611,00
			Basic colour	: WT029/70786 Sparkling Iron Effect
			Folding arm design	: Arm with LongLife technology and high-tech belt
			no. of arms	: 2 arms
			insulation [mm]	: 0 mm
			bracket type 1	: wall fixing 150 mm Opal Design II
			number of brackets 1	: 3 Piece 117,00

weinor Ltd
73 Cornhill
GB-EC3V 3QQ London
weinor.com

Managing Director:
Thilo Weiermann
General partner:
Weinor Beteiligungs-GmbH
Köln

VAT no.: 335 2381 16
Company no.: 12193066
UTR no.: 33431 24084
EORI no.: GB335238116000

Domestic transfers:
Commerzbank London
Sort Code: 406201
Account Number: 307 537 10

International transfers:
Commerzbank London
IBAN: GB51 COBA 4062 0130 7537 10
Swift: MIDLGB22 a/c COBAGB2X

weinor Ltd 73 Cornhill EC3V 3QQ London

customer: 165708 sales order 202789059

Page 3 of 4

pos quantity article code

value of goods	discount amount / %	net
4.169,00	1.667,60 / 40,00	2.501,40

999 1,00 127887-0000 net material cost surcharge

Pos 2 - Opal Design II - 48,00 GBP

48,00

value of goods	discount amount / %	net
48,00	0,00 / 0,00	48,00

value of goods	discount amount	net	VAT (0 %)	Total GBP
4.217,00	1.667,60	2.549,40	0,00	2.549,40

Appointment For Ben From 07-07-2023 To 07-07-2023

Friday 07-07-2023

07:30 AM Mark Jordan At The Beach Ltd, . Mark Jordan, , La Route De La Haule, St Peter, JE3 7YD, 745045, 07797850043 Magda magda@markjordanatthebeach.com

SO14699 Fitter *done* 1 Fit repaired heater, new bulb(s) and block

08:30 AM Risley Electrics Ltd, Mr. Scott Risley, , Maxville, La Grande Route De Mont A Labbe, St Helier, JE2 3HA, 510413, 07797 772 879, 07797 796 556 info@risley.eu

SO14647 Fitter 3 Stair case repair - motor and idle end here from Somfy. Roche Bois, Mont A Tour, St Aubin, JE3 8LP
booked in with Davina @ Risley

11:00 AM Amcorp Jersey, Mr. Adrian Chapman, , 2nd Floor Commercial House, Commercial Street, St Helier, JE2 3RU, 07797718229, adrian@amcorp.co.uk

SO13213 Fitter 4 skylight now connected. - finish off job. The Grove, Le Mont Cambrai, St Lawrence
can go anytime/day

12:30 PM Mr. Mark Williams, , Dove Cottage, Rue Du Haut, St Lawrence, , JE3 1JZ, 07797722016,

SO14812 Fitter *Sizes on the back* 1 Awning 20 years old - brackets broke, awning fell down. power isolated. wants to see if can be repaired, new brackets etc

2 bungalow brackets

13:30 PM Ms. Didy Cook, , Apartment 625 Millais House, La Rue De L Etou, Castle Quay, St Helier, JE2 3EF, 878574, 07797792252 didy3@icloud.com

SO14137 Fitter 20 Wall remote and surround keys from concierge as usual

15:30 PM . Borrowman, , Petite Combraie, La Rue De Combraie, Trinity, JE3 5AL, 867739, borrowman@bigpond.com

SO14769 Fitter *Receiver is playing up. Quote for replacement* 1 awning remote not working. have changed batteries but no lights on it. take spare with you

16:30 PM

Miscellaneous office / query time

3 LP Stainless Steel
will finish S/Adceks

