



Delivered by DSV Road Limited



SO1CI-BCJ89

**Deliver**  
CP INTERIORS  
RUE DES PRESS TRADING EST  
JE2 7QPST SAVIOUR  
JERSEY

Phone +441534768141  
Delv. --  
Delv. Time  
Ref MR PETER BAILEY / ANDY BROWN

Contact CARRERA ROBERTS  
Phone +44 1489 563184 Page 2(2)

**Shipper**  
SHUTTERCRAFT UK  
NEWDOWN FARM  
MICHELDEVER  
WINCHESTER  
HAMPSHIRE SO21 3BT

**DELIVERY ADVICE**  
**Date** 2022-02-04  
**Reference** SOJE32-5113 SO1CI-BCJ89  
**Terms** FREE ON BOARD  
F.O.B.  
JERSEY  
Originating member EBOO

**Consignee**  
CP INTERIORS  
RUE DES PRESS TRADING EST  
JE2 7QPST SAVIOUR  
JERSEY

Coll. 2022-02-03/  
Unit.no DSV952001  
Haulier -  
Reg.no.

SO12150 Bailey  
SO12515 Brown  
SO12558 Lebracq

Arrived  
7-2-22

DELIVERY ADVICE

RECEIVED  
07 FEB 2022  
SCANNED

All business is transacted according to trading conditions that exclude or limit the liability of the company in certain circumstances. A copy of the relevant set of conditions will be supplied upon request.

MR PETER BAILEY / ANDY BROWN

Marks & Nos	No.of	Pkg.	Contents	Weight	KG	Volume
	54	CLL	SHUTTERS	GW	500	3.168 CBM
				NW	500	
				EW	1054	

DSV-EURPLL \_\_\_\_\_ pcs. RETURN TO DSV

DSV FreightLetter V. 2.2 Printdate 2022.02.04 - 15:44

**Delivery Note**

**Customer Copy**

*BCW889*



CP Interiors

C/O DSV Road Ltd, 10 Brunel Way, Segensworth Ind Est, United Kingdom of Great Britain and Northern Ireland

Delivery Date **03 February 2022**

PO15 5TX

Order No	Customer Ref	Order Ref	No of Parcels
<b>SC-933-03</b>			
SCL21997704	Mr Peter Bailey	SO12150	5 ✓
<b>Totals</b>			<b>5</b>

*8630*

All items above received and packaged undamaged. Any claims for damages must be reported to S:Craft within 28 days

**Delivery Note**

**Customer Copy**



CP Interiors

DSV Road Ltd, 10 Brunel Way, Segensworth Ind Est, Hampshire, United Kingdom of Great Britain and Northern Ireland

Delivery Date **03 February 2022**

PO15 5TX

Order No	Customer Ref	Order Ref	No of Parcels
<b>SC-433-03</b>			
SCS211005390	Mr David Le Brocq	SO12558 - Le Brocq	2
SCR211005005	Andy Brown	SO12515 - Brown	47
<b>Totals</b>			<b>49</b>

All items above received and packaged undamaged. Any claims for damages must be reported to S:Craft within 28 days

# LE BROCCQ S012558

#	ROOM	TYPE	LOUVRE	CONFIG	WIDTH	HEIGHT	MIDRAIL	SQ. M	FRAMES	TILT ROD	STILE	COLOUR	HINGE COLOUR	DRAWING
1	Bathroom	Full Height	76mm	LR	828	995		0.82	Beaded L Frame 46mm	Silent Tilt	50.8mm Beaded D-Mould Stile	Pure White	Stainless Steel	
							<b>Total</b>	0.82						

**Trade Discounted Price**

Freight method	Sea
Trade price	£256.81
Discount	-£109.14
Delivery charge	£0.00
Freight	£4.94
Sub total with discount	£152.61
<b>Total</b>	<b>£152.61</b>

# Draft Order Details

[Edit](#)

## CUSTOMER INFORMATION

Title Mr  
 First name Peter  
 Last name **Bailey**  
 Order reference **S012150**

## DELIVERY INFORMATION

Address line 1 C/O DSV Road Ltd  
 Address line 2 10 Brunel Way  
 Address line 3 Segensworth Ind Est  
 Town / City Fareham  
 County  
 Country United Kingdom of Great Britain and Northern Ireland  
 Post code PO15 5TX

## NOTES



[Order Summary](#)   [Fitting](#)

## Add Products To Order



Add Shutter



Add Blind



Add Samples & POS



Add Shutter Spares & Hardware



Shutters - Fiji

*Beaded L Frame 60mm*

[Convert To](#)

Freight Method   Sea  Air

[View Breal](#)

#	ROOM	TYPE	LOUVRE	CONFIG	WIDTH	HEIGHT	MIDRAIL	SQ. M	FRAMES	TILT ROD	STILE	COLOUR	HINGE COLOUR	STATUS	A
1	Shaped Window	Shaped	63mm	RTLRTL	2850	860		2.45	<del>Deep Plain L Frame 60mm</del>	Offset Rod	41.3mm Flat D-Mould Stile	Ivory Lace	Stainless Steel	Details complete	

**Total   2.45**

- notes on order saying to measure by template,
- Add correct battens based on this
- frame to come unassembled

Trade Discounter Price	
Trade price	£1,030
Discount	-£436
Delivery charge	£0
Freight	£14

*13/9*



Peter Bailey SOL2150



ORDER NO. SC21992672

### CP INTERIORS

#### FRAME...

\* To come unassembled as do not want frame to be split in middle. (as per conversation with mark & ellie)

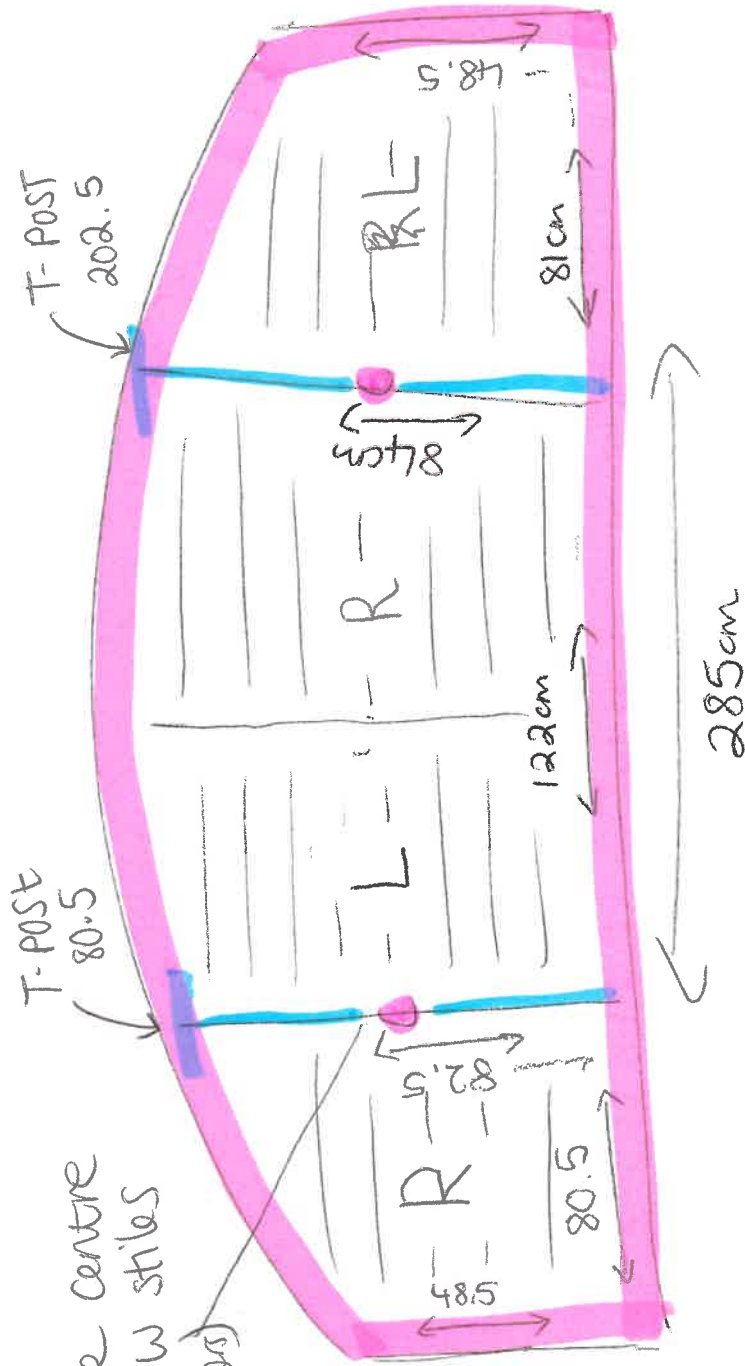

□ marks the centre of the window stiles (behind shutters)

\* please note, this drawing may not be entirely accurate, please use template provided

Order#: 211012142786	Customer Name: Peter Bailey	
Dealer#: SO12150	Dealer Name: CP Interiors	Date: 2021/09/30
Please confirm the following drawing.		

It based on template size & shape, and disregard order size. Please be aware of this and confirm the following drawing. If the drawing looks difference than the actual finished specialty shape, then factory will take a photo and show to dealer prior factory ship out." For the purpose of avoid shipping damage and easier installation; the side's frame spliced at left & right leg height. Please join the frame with wood glue and wooden dowel provided while installing the frame.

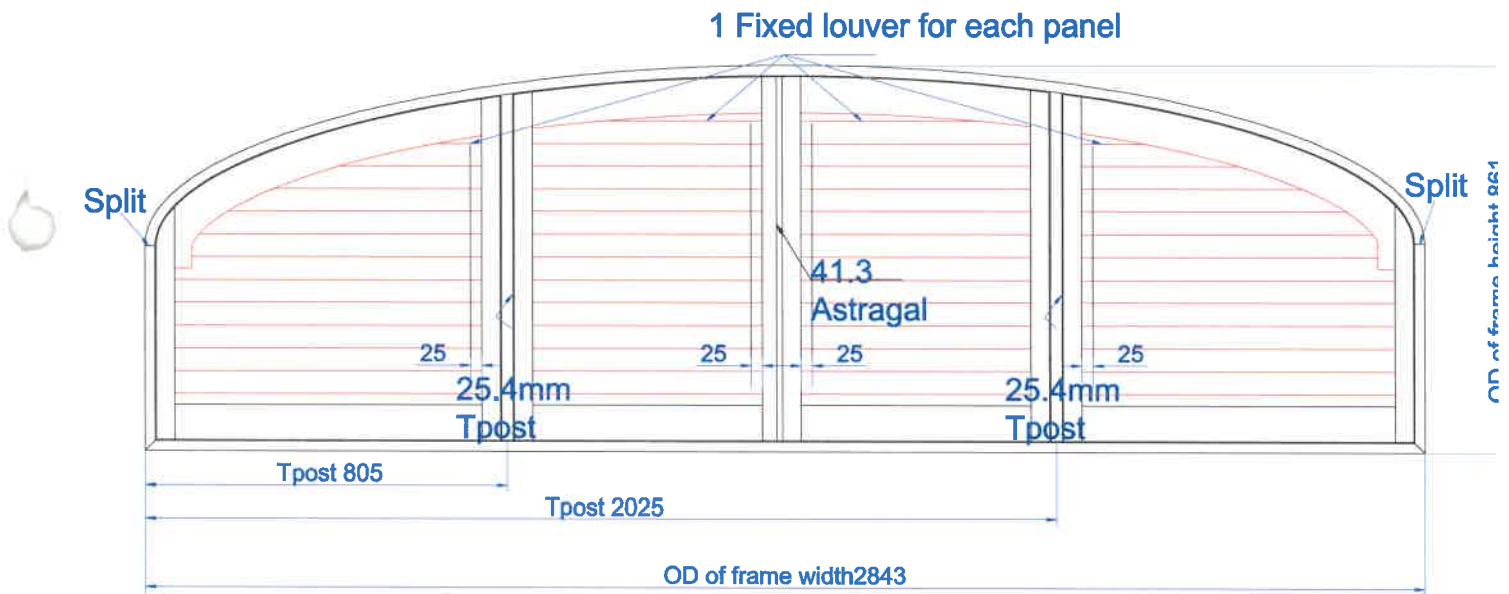

Item 1 Qty: 1(RTLRTL) Louver: 63mm Color: 007-Ivory Lace Beaded L Frame 60mm 4 sides Offset Tilt Rod



**!** Please note: Portal will be unavailable between 17:00 and 17:30 whilst we make some changes. Please do not place any orders during this time. **✕**

- [MAIN](#)
- [DRAFT ORDERS](#)
- [ORDERS](#)
- [PARTNERS](#)
- [TECHNICAL SUPPORT](#)
- [SALES & MARKETING](#)
- [COMPANY](#)

## Draft Order Details

*S-craft have not sent confirmation but is in production. Have requested to be sent. RA.*

### CUSTOMER INFORMATION

Title  
 First name **Andy**  
 Last name **Brown**  
 Order reference **SQ12515 - Brown**

### DELIVERY INFORMATION

Address line 1 **DSV Road Ltd**  
 Address line 2 **10 Brunel Way**  
 Address line 3 **Segensworth Ind Est**  
 Town / City **Fareham**  
 County **Hampshire**  
 Country **United Kingdom of Great Britain and Northern Ireland**  
 Post code **PO15 5TX**

### NOTES

*Have requested to be sent. RA.*

[Order Summary](#)   [Fitting](#)

## Add Products To Order

  
 Add Shutter

  
 Add Blind

  
 Add Samples & POS

  
 Add Shutter Spares & Hardware

[Convert To Order](#)

### Shutters - Cuba

Freight Method   Sea  Air

[View Breakdown](#)

<input type="checkbox"/>	#	ROOM	TYPE	LOUVRE	CONFIG	WIDTH	HEIGHT	MIDRAIL	SQ. M	FRAMES	TILT ROD	STILE	COLOUR	HINGE COLOUR	STATUS	ACTIONS
<input type="checkbox"/>	1	Bedroom 4	Full Height	63mm	LR	620	860		0.53	Beaded L Frame 60mm	Silent Tilt	41.3mm Beaded D-Mould Stile	Pure White	Pure White	Details complete	
<input type="checkbox"/>	2	Bedroom 4	Full Height	63mm	LR	615	860		0.53	Beaded L Frame 60mm	Silent Tilt	41.3mm Beaded D-Mould Stile	Pure White	Pure White	Details complete	
<input type="checkbox"/>	3	Bedroom 1	Full Height	63mm	LR	760	1245		0.95	Beaded L Frame 60mm	Silent Tilt	41.3mm Beaded D-Mould Stile	Pure White	Pure White	Details complete	
<input type="checkbox"/>	4	Bedroom 1	Full Height	63mm	LR	765	1245		0.95	Beaded L Frame 60mm	Silent Tilt	41.3mm Beaded D-Mould Stile	Pure White	Pure White	Details complete	
<input type="checkbox"/>	5	Ensuite	Full Height	63mm	LR	750	1250		0.90	Beaded L Frame 60mm	Silent Tilt	41.3mm Beaded D-Mould Stile	Pure White	Pure White	Details complete	
<input type="checkbox"/>	6	Bathroom	Full Height	63mm	LR	705	995		0.70	Beaded L Frame 60mm	Silent Tilt	41.3mm Beaded D-Mould Stile	Pure White	Pure White	Details complete	
<input type="checkbox"/>	7	Bedroom 3	Full Height	63mm	LR	695	1005		0.70	Beaded L Frame 60mm	Silent Tilt	41.3mm Beaded D-Mould Stile	Pure White	Pure White	Details complete	
<input type="checkbox"/>	8	Landing	Full Height	63mm	LR	770	1255		0.97	Beaded L Frame 60mm	Silent Tilt	41.3mm Beaded D-Mould Stile	Pure White	Pure White	Details complete	
<input type="checkbox"/>	9	Cloak room	Full Height	63mm	LR	780	1275		0.99	Beaded L Frame 60mm	Silent Tilt	41.3mm Beaded D-Mould Stile	Pure White	Pure White	Details complete	
<input type="checkbox"/>	10	Utility	Full Height	63mm	LR	800	1260		1.02	Beaded L Frame 60mm	Silent Tilt	41.3mm Beaded D-Mould Stile	Pure White	Pure White	Details complete	

Saved successfully.

Total   20.95