

P2

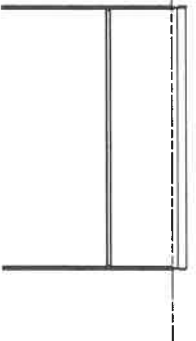

S1

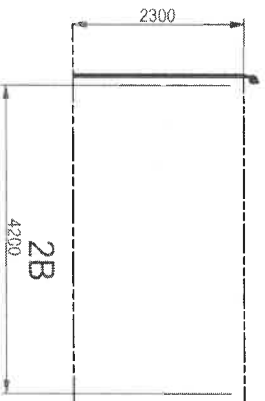

P4

S2



S1

2B

P1

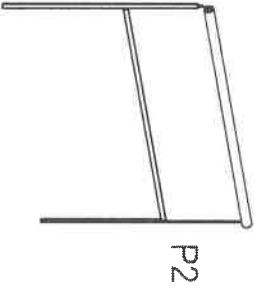

S1

P2

P1

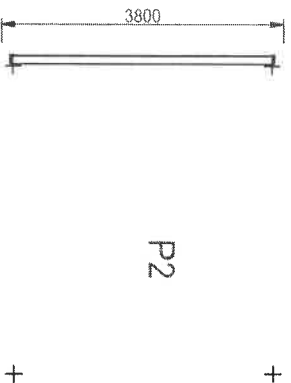

1B

1A

S2

1A

S2

1B

1A

S2

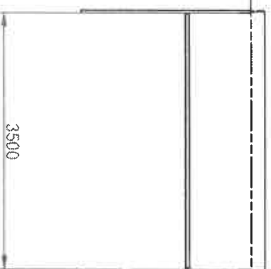

2A

P2

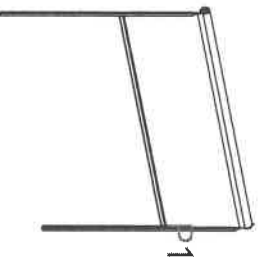

S1

2A

S1

2B

S1

S2

Depending on the phase you are in you have received a quote or an order drawing.
The quote drawing is a standard drawing based on a standard configuration.
Any remarks and/or attachments are not visible on the quote drawing.
In the order drawing we integrate as much as possible any remarks and/or attachments.
Remarks or attachments that can not be integrated in the order drawing will be considered when your order goes in production.

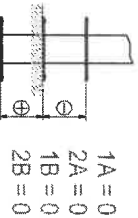

1A = 0
2A = 0
1B = 0
2B = 0

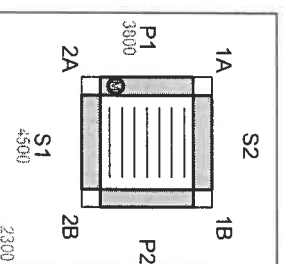

2300



Client Reference :

Ordering ref. : 0003955400200048727

Client :

Creation date : 05/02/2021 11:53:06

Color :

Sheet : 1/1
Scale : 1 : 60
Drawn : ALD/HQR

www.renson.be - 8790 Weingan (Belgium)

The drawing is owned by RENSON and may not be copied or otherwise used without the prior written permission of RENSON.

Size : A3

units in mm

P2

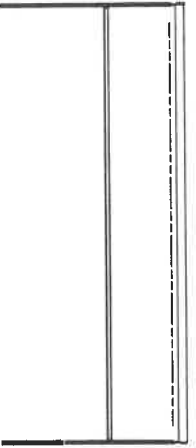

2B

1B

P1

S2

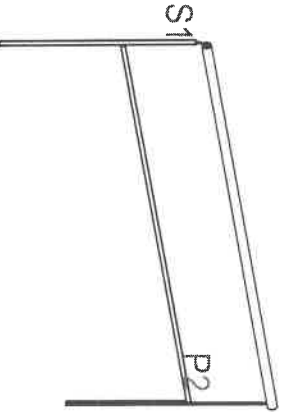

S1

P2

P2

S1

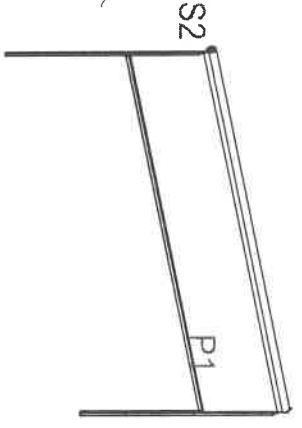

S2

P1

S1

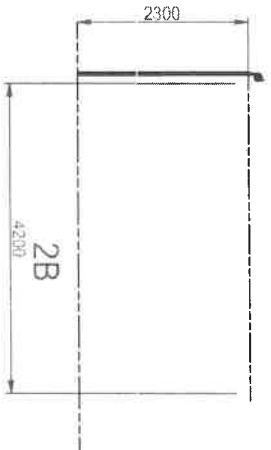

2300

2B

1A

1A

1B

S2

+

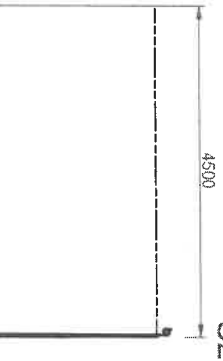

4500

S2

P1

P2

1B

1A

2A

S1

2B

+

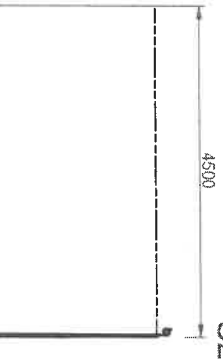
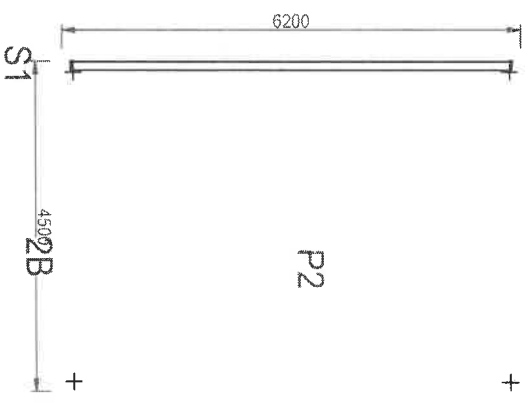

P2

S2

S1



Depending on the phase you are in you have received a quote or an order drawing.
The quote drawing is a standard drawing based on a standard configuration.
Any remarks and/or attachments are not visible on the quote drawing.
In the order drawing we integrate as much as possible any remarks and/or attachments.
Remarks or attachments that can not be integrated in the order drawing will be considered when your order goes in production.

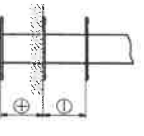

1A = 0
2A = 0
1B = 0
2B = 0

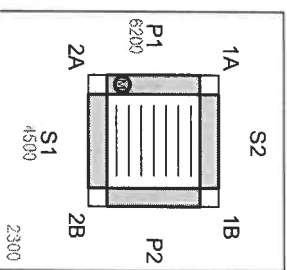

2300

Sheet: 1/1

Scale: 1:50

Drawn: AudeHOC30

Size: A3
units in mm

Client Reference :

Orderline ref. : 0038964003000.48726

Client :



Creating healthy spaces

www.renson.eu - 0700 Wategem (Belgium)
© Renon is a trade name used without permission.

0008964003000.48726_Camargue 2 Configurator

Receid9393 9e4a-4750-9e1a-530509f81a726

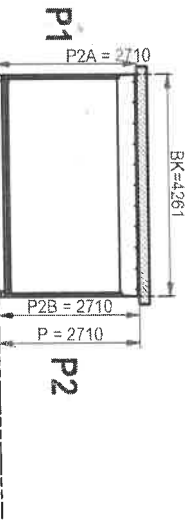
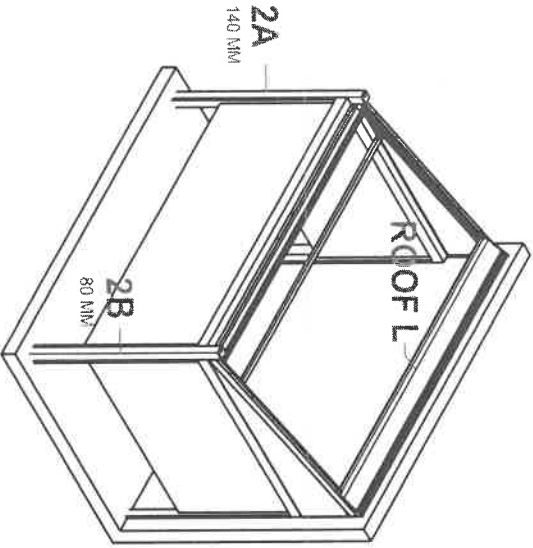
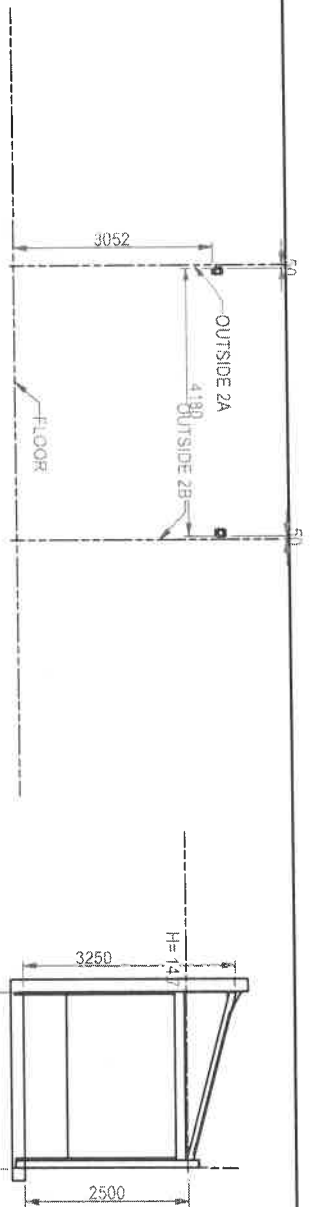

S1.1

S1.2

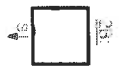

Depending on the phase you are in you have received a quote or an order drawing. The quote drawing is a standard drawing based on a standard configuration. Any remarks and/or attachments are not visible on the quote drawing. In the order drawing we integrate as much as possible any remarks and/or attachments. Remarks or attachments that can not be integrated in the order drawing will be considered when your order goes in production.

Client:		Order n.°:
Description:		Project n.°:
Doc. n.°:		Doc. n.°:
Creation date:		Scale:
Sheet:		Drawn:
Size:		Units in mm



www.renson.eu - 8790 Wiersem (Belgium)

This drawing is owned by RENSON and may not be copied or shown to third parties without their permission.

0009864001000.51571_Lagune_Pure_Configurator

S = 4261