

SENT TO  
ARCHITECT  
2018.

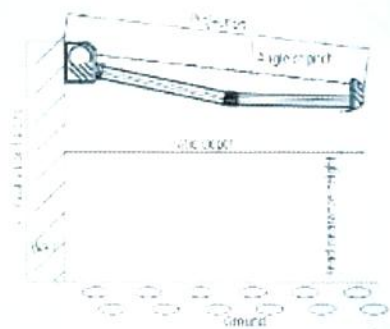

### Site measurements – determining the projection and head clearance height

- Find the projection by looking in the "Projection" table for the terrace depth.
- Using the projection from that table and the required angle of pitch, consult the "head clearance height" table for the head clearance height. This head clearance height refers to an installation height of 300 cm.
- Add/subtract the difference between 300 cm and the actual installation height to/from the head clearance height in the table.

#### Determining the projection

Angle of pitch	Terrace depth in cm					
	150	200	250	300	350	400
15°	140	200	250	300	350	400
20°	140	210	280	310	380	400
25°	140	220	300	330	380	400

Projection in cm (rounded off).

This table can be used to find the awning projection for any given horizontal terrace depth.

#### Determining the head clearance height

Angle of pitch	Projection in cm					
	150	200	250	300	350	400
15°	100	130	170	210	250	310
20°	100	140	190	230	280	340
25°	100	150	200	250	300	360

Head clearance height in cm (rounded off).

This table is used to find the head clearance heights for various projections (when the angle of pitch is 15°, 20° or 25°).

This table is based on the example of an installation height of 300 cm (upper edge of awning).

Sizes and bracket recommendations



Width in cm	Number of arms	Projection in cm (irregular figures possible)					
		150	200	250	300	350	400
150	2	●	●	●			
150-200	2	●	●	●	●		
200-250	2	●	●	●	●	●	
250-300	2	●	●	●	●	●	●
300-350	2	●	●	●	●	●	●
350-400	2	●	●	●	●	●	●
400-450	2	●	●	●	●	●	●
450-500	2	●	●	●	●	●	●
500-550	2	●	●	●	●	●	●
550-600	2	●	●	●	●	●	●
600-650	2	●	●	●	●	●	●
650-700	3	●	●	●	●	●	●

Wall mounting on C20/25 concrete

with up to 200 mm facing, wind resistance class 2 and a permissible centric tensile force of 5.71 kN for anchor bolts

- 2 x K 2000 standard wall brackets 85 mm
- 4 x K 2000 wall brackets 85 mm
- 2 x K 2000 wall brackets 200 mm (K5)
- ▲ 2 x K 2000 standard wall brackets 85 mm
- ▲ 2 x K 2000 wall bracket 255 mm (K7)
- ▲ Standard wall bracket 200 mm



Wall bracket 85 mm on both sides (K)

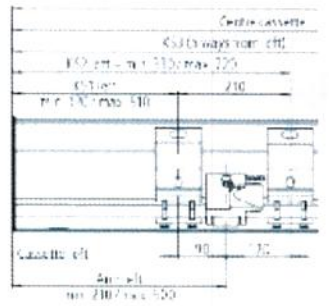

Wall bracket 85 mm outside (K51)

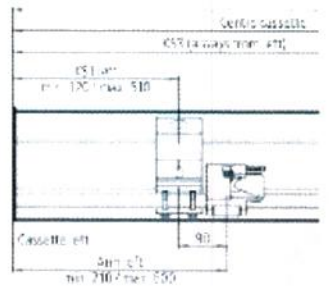

Wall bracket 85 mm inside (K52)

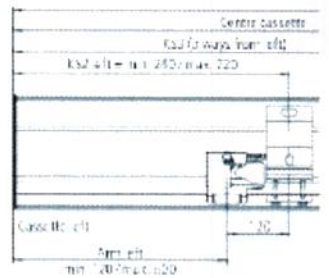

- Notes
- K51 = outside bracket
  - K52 = inside bracket
  - K53 = centre bracket

N 2000

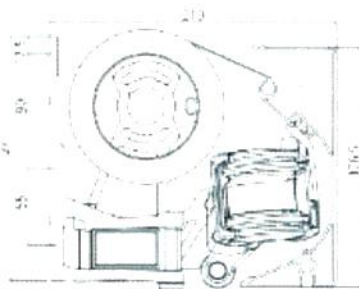

**Minimum spacing distances for installation**

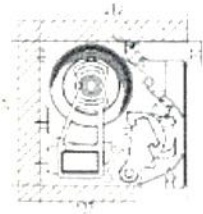

Top view of roller blind installation

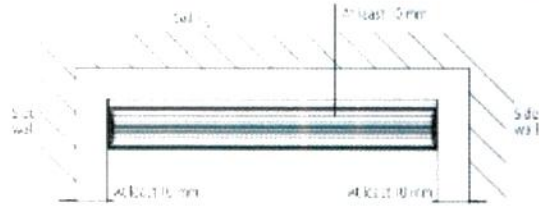

Side view of roller blind installation

*Adrian Colston-Weeks*

Adrian Colston-Weeks  
Director



Tel: (01534) 768141

[www.cpinteriors.je](http://www.cpinteriors.je)

Rue des Pres Trading Estate, St Saviour, Jersey, JE2 7QN

Blinds | Curtains | Awnings | Shutters | Furnishings | Interior Design | Project Management

## Fiona Potts

---

**From:** mike bell <mikebelljsy@hotmail.com>  
**Sent:** 06 August 2020 15:38  
**To:** Fiona Potts  
**Subject:** Re: Appt for Awning Measurement

**Categories:** Urgent

Hi Fiona,

As soon after he has received his results as possible, always assuming they are clear. I wasn't too enthusiastic about the long wait until 11th in the first place, so the soonest he can come the better. I'm available anytime on Wednesday 12th or Thursday 13th if he can come either of those days?

Best wishes

Mike

Sent from my iPad

On 6 Aug 2020, at 15:29, Fiona Potts <Fiona@cpinteriors.je> wrote:

Good Afternoon Mr Bell

With reference to your appointment on Tuesday 11<sup>th</sup> August.  
Unfortunately we will need to rebook this please, Adrian is unable to attend appointments until he receives a clear PCR Covid test after returning from his holiday on the Sunday prior, we need to leave at least 48 hours before we book anything.

If you can let me know when you are free and we will move this for you?  
Thanks

Best Regards

Fiona

**Fiona Potts**  
**Head of Customer Service and Business Development**

<image001.png>

Tel: (01534) 768141 [www.cpinteriors.je](http://www.cpinteriors.je)  
Rue Des Pres Trading Estate, St Saviour, Jersey, JE2 7QP



## Fiona Potts

---

**From:** Adrian Colston-Weeks  
**Sent:** 20 August 2020 14:51  
**To:** Fiona Potts  
**Subject:** awning

This should be all he needs  
Please send onto him

Thanks