

RECEIVED

4 FEB 2021

SCANNED

no delivery notes

vertitex : spare fabric -

weinor GmbH & Co. KG PO box 301473 D-50784 Köln

C P Interiors**Rue Des Pres Trading Estate
GB-JE2 7QN St Saviour Jersey****delivery address**Ferryspeed
FAO CP Sunblinds
Venture Park/ Ackworth Road
GB-PO3 5JT Portsmouth/ Hampshire**ORDER CONFIRMATION (release 2)**

sales order no.: 202513506 of 12.11.2020
 customer: 165708
 reference: Compl. to SO10057 Roberts /2024761
 Your order no.:
 contact person: Tea Evers
 E-Mail: Tevers@weinor.de
 phone number: +49-221-59709-450
 representat.: 654 Chris Spickett
 tel (representat.): 0044 (0) 7894443907

Dear weinor partner,

Due to the high demand on weinor products it has become necessary to confirm the despatch dates for early 2021.

As it stands today, the Brexit transition period is ending on the 1.1.2021

In case the UK and the EU are not able to set up a free trade agreement, toll tariffs will apply for weinor products imported into the UK.

We want to make you aware that the following toll costs will be added to this purchase order accordingly.

Please find detailed below the proposed toll tariffs associated with our product groups. These are accurate as of October 2020 and may be subject to change.

Obviously these will become obsolete as soon as a free trading agreement is in place.

We will keep you informed. Watch out for regular news on the common channels !

Thank you very much for your awareness and understanding.

Toll Tariff Number:	Description:	Toll tariff UK 2021:
55122990	Cut lenght fabric	8%
63061200	Readymade awnings with textile fabrics	12%
76109090	Spare parts Aluminium (profiles) for awnings	6%
85014020	Spare Motors	0%
85371098	(Remote-) Controls	2%
85162999	Heaters	2%
76101000	Constructional parts, roofs, doors, windows and their frames and profiles made of Aluminium.(Terrazza, w17c, Glazing Elements)	6%

weinor GmbH & Co. KG PO box 301473 D-50784 Köln

pos	quantity	article code
-----	----------	--------------

In accordance with weinor's General Terms and Conditions of Delivery and Payment, you as a specialist partner are obliged to check whether the delivered goods are complete and undamaged. At the very least, you should ensure that the cartons are complete and undamaged from the outside. This does not relieve you of the above obligation, but it makes it easier for you to detect irregularities. Only if you have the defect confirmed on the delivery note upon receipt of the goods can we grant a refund if necessary after checking the transaction.

1	1,00	5025	Spare fabric for vertical awnings For new overall cassette width of 2575mm		
			Anticipated delivery	: 25.01.2021	
			customer route	: 430	UK export
			Product use	: private house	
			Data of the previous construction this new construction refers to.		
			Sales order	: 202476179	0
			Posn. of the sales order	: 13	0
			Data of spare fabric for vertical awnings		
			spare cover for	: Vertitex II	
			Vertitex II version	: VertiTex II Zip 112	
			Side of control (seen from the front)	: left	
			real-design	: WE7-207	grey-grey
			price per m2	: 72	
			square meter cloth	: 6,97922	m ² 502,50
			Front side of fabric	: Konfektion 1	Front side of fabric outside (standard)
			Fabric width 1 [cm]	: 302	cm
			length of fabric [cm]	: 231,1	cm
			retoure down [cm]	: 2,5	cm
			seam [cm]	: 0	cm
			roll cover	: fabric fixed to roller tube	
			Length (mm) of roller	: 2435	29,22
			diameter of roller	: 69e roller tube	

weinor GmbH & Co. KG
Mathias-Brüggen-Strasse 110
D-50829 Köln
weinor.com

Managing Director:
Thilo Weiermann
General partner:
Weinor Beteiligungs-GmbH
Köln

VAT no.: DE 122814372
Tax ID no.: 217/5866/0097
Place of registration: Cologne
Company reg. no.: HRA 5676
Place of registration: Cologne
Company reg. no.: HRB 4661

Commerzbank London
Sort Code 40-62-01
Swift BIC Code COBAGB2X
Account no: 30266480
IBAN: GB24 COBA 4062 0130 2664 80

weinor GmbH & Co. KG PO box 301473 D-50784 Köln

customer: 165708 sales order 202513506

Page 3 of 3

pos	quantity	article code
-----	----------	--------------

value of goods	discount amount / %	net
531,72	212,69 / 40,00	319,03

value of goods	discount amount	net	VAT (0 %)	Total GBP
531,72	212,69	319,03	0,00	319,03

This order confirmation is according to the current terms of payment and delivery.

<https://www.weinor.com/agb/>

delivery exw Cologne
 payment: Direct debit / 3 days - 4% cash discount
 mode of dispatch UK export

Configuration details

weinor GmbH & Co. KG PO box 301473 D-50784 Köln

customer: 165708

reference: SO9687 Roberts

Page 19 of 22

isometric view

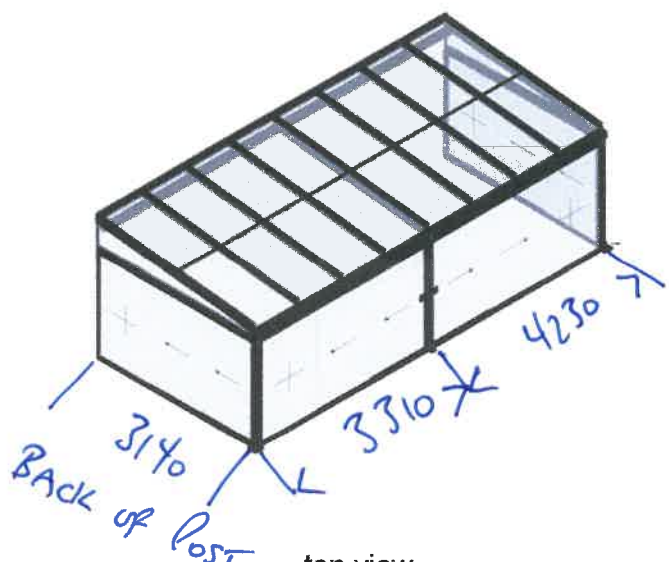

top view

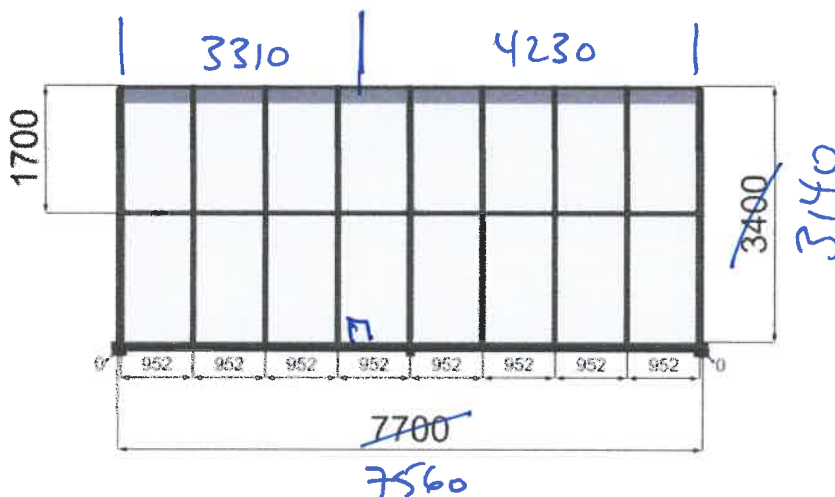

weinor GmbH & Co. KG
Mathias-Brüggen-Strasse 110
D-50829 Köln
weinor.com

Managing Director:
Thilo Weiermann
General partner:
Weinor Beteiligungs-GmbH
Köln

VAT no.: DE 122814372
Tax ID no.: 217/5866/0097
Place of registration: Cologne
Company reg. no.: HRA 5676
Place of registration: Cologne
Company reg. no.: HRB 4661

Commerzbank London
Sort Code 40-62-01
Swift BIC Code COBAGB2X
Account no: 30266480
IBAN: GB24 COBA 4062 0130 2664 80

Configuration details

weinor GmbH & Co. KG PO box 301473 D-50784 Köln

customer: 165708

reference: SO9687 Roberts

Page 20 of 22

front view

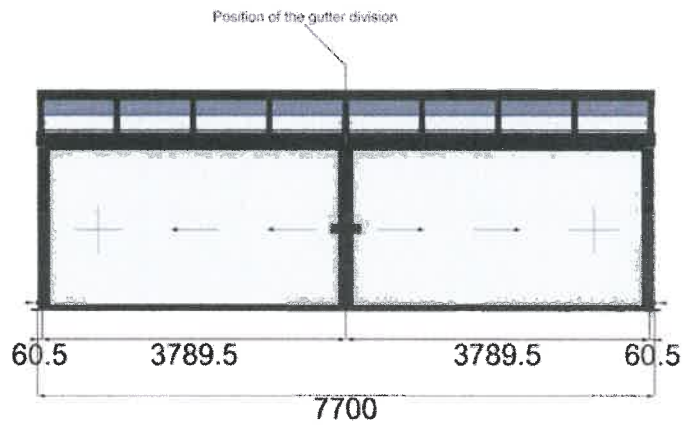

side view left

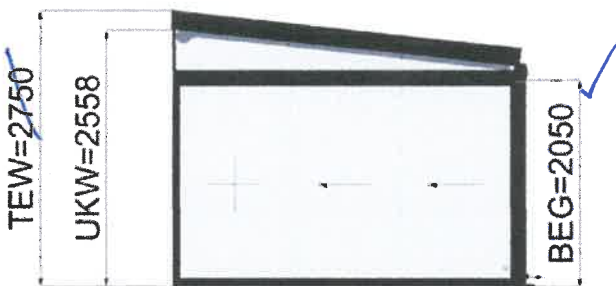

side view right

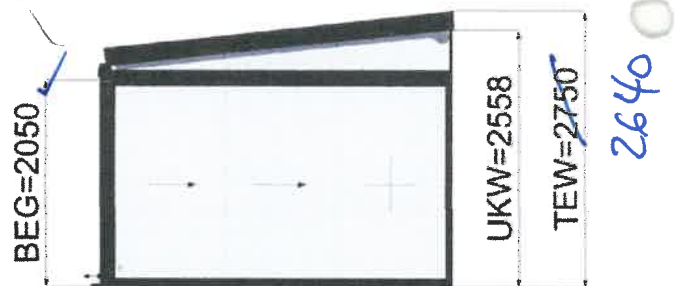

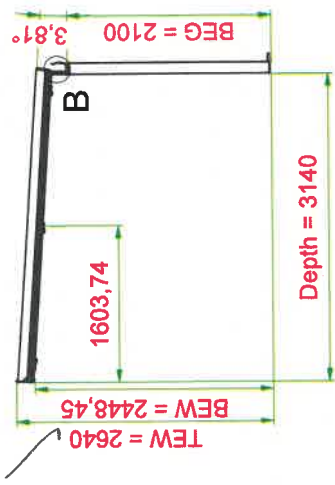
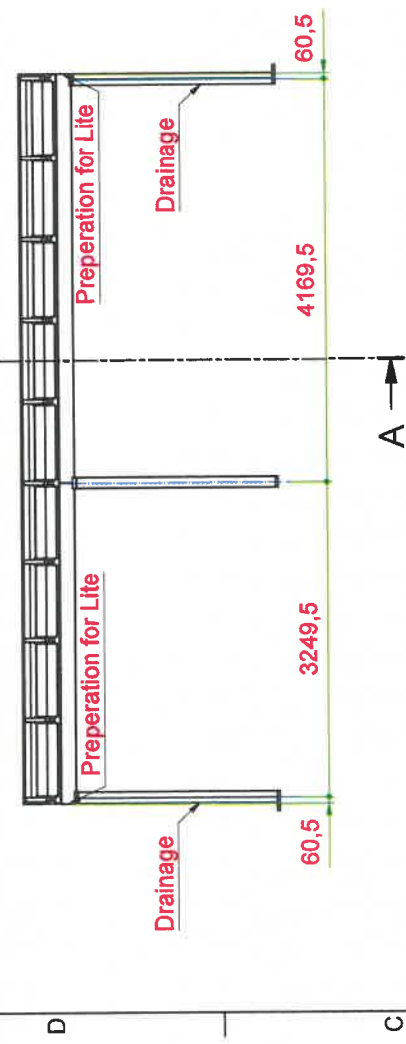

release 3

A-A (1:50)

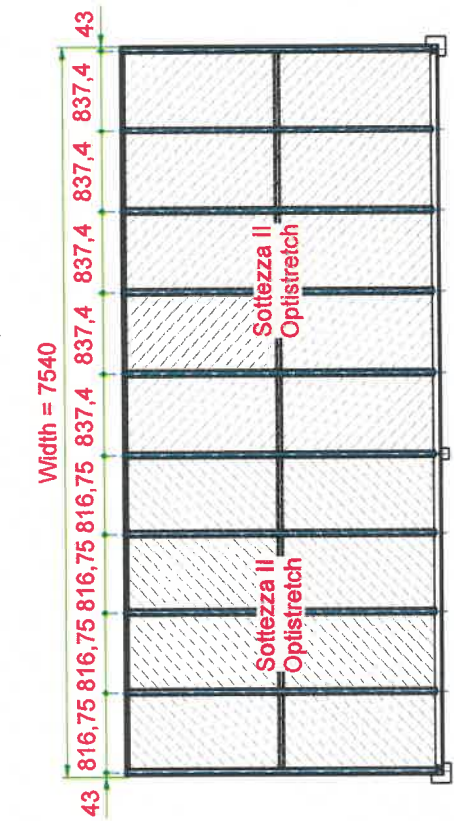

B (1:10)



Selected roof covering: VSG 10mm 5-5-2; Keildichtung 7-10; To be approved on site Keildichtung WAS 4-7mm	Order number-position: 202476179-001	Contact person: Chris Nicolson	Scale: 1 : 50
Colour: RAL 7015 Takeseal grau	Reference: 001	Drawing number: TBS2-D-00174592	
Release: (Signature) (Date)	Client: C P Interiors	Awnings Patio roofs Glasoasen	1 2 3 4 5 6

