



Above glass awning

## markilux 770 tracfix

The clean and concise exterior awning for medium-sized areas.



reddot design award  
winner 2017



GERMAN  
DESIGN  
AWARD  
WINNER  
2018

[markilux.com](http://markilux.com)

**markilux**  
safe timeless beautiful

# Product Characteristics

Wind resistance class 3  
Beaufort 6 → 38–48 km/h → 10.5–13.4 m/s → 24–30 mph

01  
02  
03  
04  
05  
06  
07  
08  
09  
10  
11  
12  
13  
14  
15  
16  
17  
18  
19



1 side view track-only fixture

2 when extended, the front profile finishes flush with the end of the guide tracks

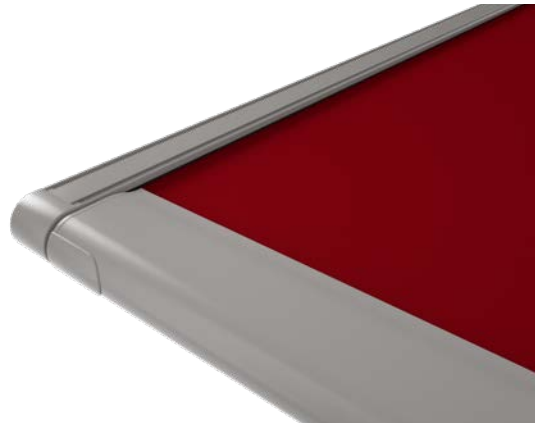

3 tracfix cover guidance system – leaves no gap between the cover and the guide track



## Product Characteristics

### Description

- exterior awning for conservatories and glass canopies. One awning can shade an area of up to 18 m<sup>2</sup>

### Special features

- fully encompassing cassette that protects the cover perfectly
- tried and tested tensioning system with drive belts and integrated gas pistons – delivers optimum cover tension in any phase of extension
- with tracfix system, the continuous lateral cover guidance system that leaves no gap between the cover and guide tracks – gives improved wind stability and a cleaner appearance
- the broad range of brackets with patented clip-on system offers individual fixture solutions

### Dimensions

- single unit: awning fixture width 60–450 cm in width, maximum extension 400 cm
- maximum dimensions, awning fixture width × extension: 450 cm × 400 cm
- intermediate sizes are available

### Roller tube and lateral bearings

- round roller tube Ø 85 mm with keyway, galvanised steel – excellent stability, ensures near perfect cover performance even at the largest widths
- the roller tube bearing is made of stainless steel

### Awning profiles

- extruded aluminium, in façade quality, powder coated
- cassette profile in two pieces, angular, height × depth 125 mm × 125 mm
- guide tracks angular, rounded edges, width × height 52 mm × 52 mm
- front profile rounded at the front, depth × height 110 mm × 52 mm

### End caps

- the cassette end caps are made of die-cast aluminium, in two parts, powder coated
- the front profile end caps are made of high-quality plastic, powder coated

### Fixture brackets

- extruded aluminium, powder coated
- cassette is self-supporting on guide tracks
- brackets for the guide tracks: stand-off brackets, reveal fixture, flat track brackets for lateral fixture
- standard bracket heights: 105 mm / 145 mm / 100–500 mm (bespoke heights can be ordered)
- other accessories are available

01  
02  
03  
04  
05  
06  
07  
08  
09  
10  
11  
12  
13  
14  
15  
16  
17  
18  
19

**15**

## Frame colours

### markilux frame colours without surcharge

traffic white, RAL 9016



metallic aluminium, RAL 9006



grey brown, similar to RAL 8019



off-white textured finish, 5233 <sup>1)</sup>



stone grey metallic, 5215 <sup>1)</sup>



anthracite metallic, 5204 <sup>1)</sup>



havana brown textured finish, 5229 <sup>1)</sup>



15

### Non-standard powder-coated finish

Bespoke frame colours incur a surcharge – matt, metallic, finely textured and pearl finishes as well as other colour ranges (DB, Tiger etc.) on request. All frame colours are available at a surcharge with enhanced corrosion protection.

Colours may differ slightly from those depicted in both hue and finish.

<sup>1)</sup> textured finish

# Dimensions and configuration options

Single unit

		Awning fixture width						Minimum fixture width		
		150	200	250	300	350	400	450	Hard-wired motor	Radio-controlled motor
Order dimensions		72	151	201	251	301	351	401	72	82
		150	200	250	300	350	400	450		
		+ 5,4								
H	150								107 <sup>1)</sup>	107 <sup>1)</sup>
	200									
	250									
	300									
	350									
	400									

dimensions in cm

1) = from an extension of 281 cm

H = extension

= 4 brackets

= 6 brackets

= 6 brackets,  
1 cover support tube

Operation	standard	optional
crank handle	—	—
hard-wired motor	✓	—
silentec motor (optionally with an external io / RTS receiver)	—	—
radio-controlled motor io, 868 MHz	—	✓
radio-controlled motor RTS, 433 MHz	—	✓
868 MHz radio-controlled motor io with manual override	—	—

### Coupled awnings

not available

### Optional accessories

automatic controls (light, wind, rain)

N.B. Important background information can be found in the chapter "Optional Accessories"

Awning cover	fabric pattern no.	standard	optional
sunvas	300..-315..	✓	—
sunsilk	324.. / 325.. / 328.. / 369..	✓	—
sunbow	411..-427..	✓	—
smart art	340..	—	✓
perla FR	371.. / 372..	—	✓
perfotex	331.. / 332..	✓	—
transolair	338..	—	✓
transolair (120 cm)	339..	—	✓
vuscreen Alu	317..	—	✓
Soltis Perform 92	92-..	—	✓

### Shadeplus

not available

**sunvas**  
**transolair**  
**perla FR**  
 Fabric width 120 cm

Fabric pattern 301.. / 309.. – 315..  
 339..  
 371..<sup>3)</sup> / 372..<sup>3)</sup>

**smart art**  
**sunsilk**  
 340..  
 324.. / 325.. / 328.. / 369..

		Awning fixture width						
		150	200	250	300	350	400	450
AH	150							
	200							
	250							
	300							
	350							
	400							

**sunvas**  
 Fabric pattern 31008..<sup>1)</sup>, -09<sup>1)</sup>, -13, -16, -18, -25, -27, -28, -31, -36, -37, -57, -58, 31109, -14, -17  
 Fabric width 250 cm

		Awning fixture width						
		150	200	250	300	350	400	450
AH	150							
	200							
	243							
	300				1)	1)	1)	
	350				1)	1)	1)	
	400				1)	1)		

1) also available in fabric width 320 cm – then seamless

**sunbow**  
 Fabric pattern 411.. - 427..  
 Fabric width 120 cm

		Awning fixture width						
		150	200	250	300	350	400	450
AH	150							
	200							
	250							
	300							
	350							
	400							

**Note:** The maximum width of the outer panels in tracfix systems with vertical panel joints is 35 cm  
 [Yellow] = vertical panel joints (panel width approx. 120 cm)      [Light Green] = seamless      [Grey] = not available  
 [Dark Green] = horizontal panel joint(s)      **AH** = unit height

dimensions in cm

**transolair** Fabric pattern 338..  
Fabric width 250 cm

		Awning fixture width						
		150	200	250	300	350	400	450
AH	150	Seamless	Seamless	Seamless	Seamless	Seamless	Seamless	Vertical panel joints
	200	Seamless	Seamless	Seamless	Seamless	Seamless	Seamless	Vertical panel joints
	243	Seamless	Seamless	Seamless	Seamless	Seamless	Seamless	Vertical panel joints
	300	Horizontal panel joint(s)	Horizontal panel joint(s)	Horizontal panel joint(s)	Horizontal panel joint(s)	Horizontal panel joint(s)	Horizontal panel joint(s)	Vertical panel joints
	350	Horizontal panel joint(s)	Horizontal panel joint(s)	Horizontal panel joint(s)	Horizontal panel joint(s)	Horizontal panel joint(s)	Horizontal panel joint(s)	Vertical panel joints
	400	Horizontal panel joint(s)	Horizontal panel joint(s)	Horizontal panel joint(s)	Horizontal panel joint(s)	Horizontal panel joint(s)	Horizontal panel joint(s)	Vertical panel joints

**perfortex** Fabric pattern 331.. / 332..  
Fabric width 120 cm

		Awning fixture width						
		150	200	250	300	350	400	450
AH	150	Vertical panel joints	Vertical panel joints	Vertical panel joints	Vertical panel joints	Vertical panel joints	Vertical panel joints	Vertical panel joints
	200	Vertical panel joints	Vertical panel joints	Vertical panel joints	Vertical panel joints	Vertical panel joints	Vertical panel joints	Vertical panel joints
	250	Vertical panel joints	Vertical panel joints	Vertical panel joints	Vertical panel joints	Vertical panel joints	Vertical panel joints	Vertical panel joints
	300	Vertical panel joints	Vertical panel joints	Vertical panel joints	Vertical panel joints	Vertical panel joints	Vertical panel joints	Vertical panel joints
	350	Vertical panel joints	Vertical panel joints	Vertical panel joints	Vertical panel joints	Vertical panel joints	Vertical panel joints	Vertical panel joints
	400	Vertical panel joints	Vertical panel joints	Vertical panel joints	Vertical panel joints	Vertical panel joints	Vertical panel joints	Vertical panel joints

**Serge 600 (not available)** Fabric pattern 272..  
Fabric width 250 cm

		Awning fixture width						
		150	200	250	300	350	400	450
AH	150	Not available	Not available	Not available	Not available	Not available	Not available	Not available
	200	Not available	Not available	Not available	Not available	Not available	Not available	Not available
	250	Not available	Not available	Not available	Not available	Not available	Not available	Not available
	300	Not available	Not available	Not available	Not available	Not available	Not available	Not available
	350	Not available	Not available	Not available	Not available	Not available	Not available	Not available
	400	Not available	Not available	Not available	Not available	Not available	Not available	Not available

**Soltis Perform 92** Fabric pattern 277..  
Fabric width 177 cm

		Awning fixture width						
		150	200	250	300	350	400	450
AH	150	Seamless	Seamless	Seamless	Seamless	Seamless	Seamless	Not available
	180	Seamless	Seamless	Seamless	Seamless	Seamless	Seamless	Not available
	250	Seamless	Seamless	Horizontal panel joint(s)	Horizontal panel joint(s)	Horizontal panel joint(s)	Horizontal panel joint(s)	Not available
	300	Seamless	Seamless	Horizontal panel joint(s)	Horizontal panel joint(s)	Horizontal panel joint(s)	Horizontal panel joint(s)	Not available
	350	Not available	Not available	Not available	Not available	Not available	Not available	Not available
	400	Not available	Not available	Not available	Not available	Not available	Not available	Not available

**Note:** The maximum width of the outer panels in tracfix systems with vertical panel joints is 35 cm

= vertical panel joints (panel width approx. 120 cm)
  = seamless
  = not available
  = horizontal panel joint(s)
 AH = unit height

dimensions in cm

## Fixtures, fittings and accessories

01  
02  
03  
04  
05  
06  
07  
08  
09  
10  
11  
12  
13  
14  
15  
16  
17  
18  
19

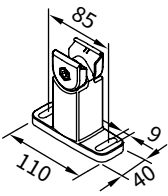

track bracket, with adjustable head  
100 mm

**76046.**

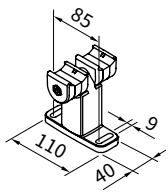

double track bracket with adjustable head  
100 mm  
central bracket for 2 single units next to each other

**73634.**

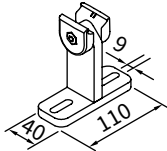

track bracket for conservatory transom fixture  
100 mm

**76055.**

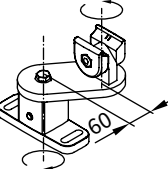

windmill track bracket  
100 mm

**76054.**

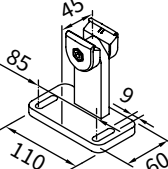

track bracket with offset footplate  
100 mm

**76199.**

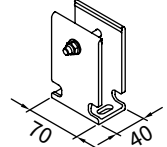

track bracket for track-only fixture, rigid  
100 mm

**76017.**

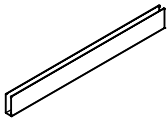

track bracket for track-only fixture, rigid by the metre, undrilled, 100 mm  
maximum length 6 mm

**76013.**

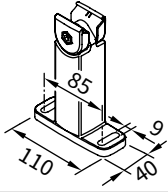

track bracket, with adjustable head  
140 mm

**76048.**

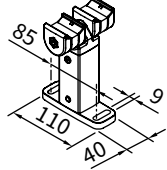

double track bracket with adjustable head  
140 mm  
central bracket for 2 single units next to each other

**73636.**



track bracket, with adjustable head and foot  
200–500 mm

**76045.**



track bracket, with adjustable head  
140–500 mm

**76047.**

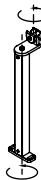

universal track bracket with adjustable head  
140–500 mm

**76053.**

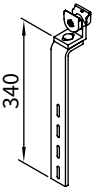

flat track bracket with adjustable head  
for lateral guide track fixture  
340

**76049.**

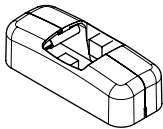

covering cap for square track bracket  
standard accessory for bracket

**2 × 76718.**

## Fixtures, fittings and accessories

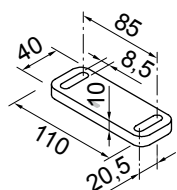

spacer plate  
for track bracket  
110 × 40 × 10 mm

**78570.**

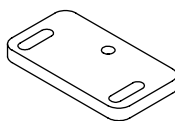

adapter plate  
for track bracket  
110 × 60 × 10 mm

**78158.**

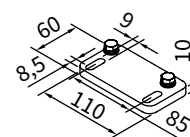

adapter plate  
for track bracket  
110 × 60 × 10 mm

**78165.**

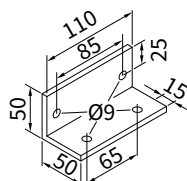

angled mounting  
bracket

**76098.**

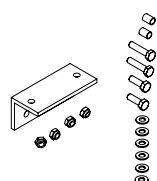

angled mounting  
bracket 76098.  
including coupling bolts

**76099.**

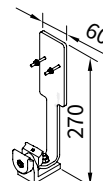

fixture bracket for light  
and / or wind and/or  
rain sensor

**76050.**

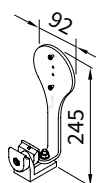

bracket for sun and/or  
wind sensor io

**76723.**

01  
02  
03  
04  
05  
06  
07  
08  
09  
10  
11  
12  
13  
14  
**15**  
16  
17  
18  
19

# Fixture types

## 21

Clearance 105 mm

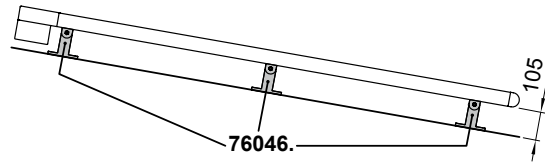

## 22

Clearance 145 mm

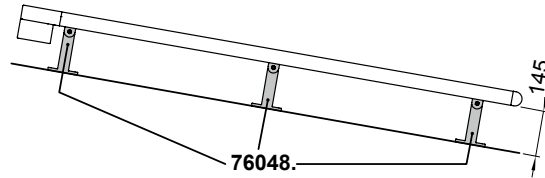

## 30

Flat track bracket

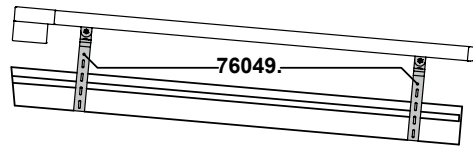

Individual bracket selection:

See "Fixtures, fittings and accessories".  
Awning extension > 300 cm, always  
3 brackets per guide track.

### Overview of dimensions

Fixture type 21,22

Fixture type 30

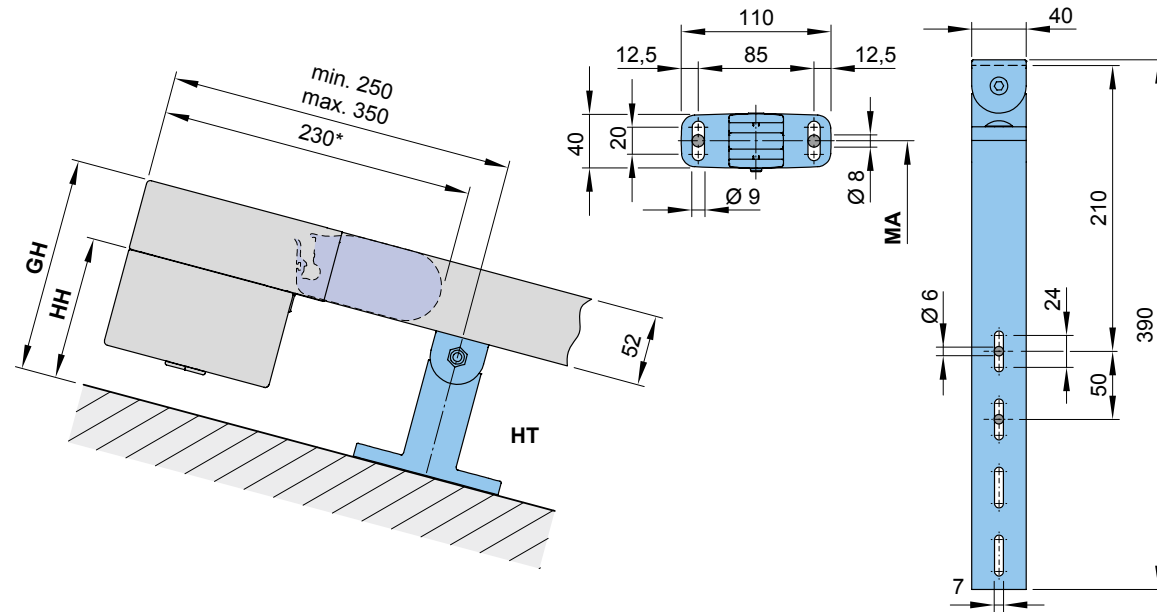

fixture type 21

fixture type 22

fixture type 30

HT	= bracket	76046.	76048.	76049.
HH	= bracket height	105	145	ca. 195–335
GH	= overall height	157	197	ca. 247–387
MA	= <b>order dimension</b> = blind fixture width = fixture width			
*	= extension when retracted			

dimensions in mm

# Overview of dimensions

Single unit

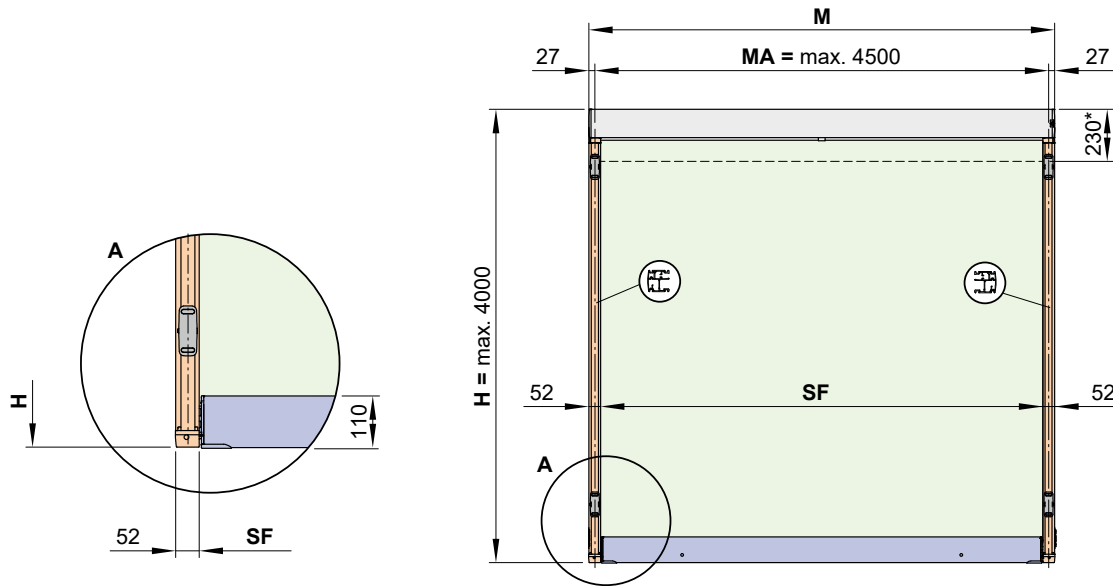

Two single units - fixture via double track brackets

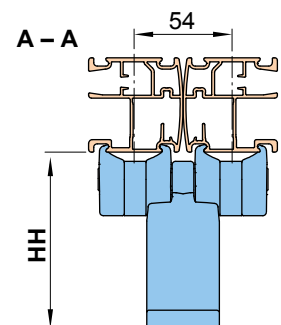
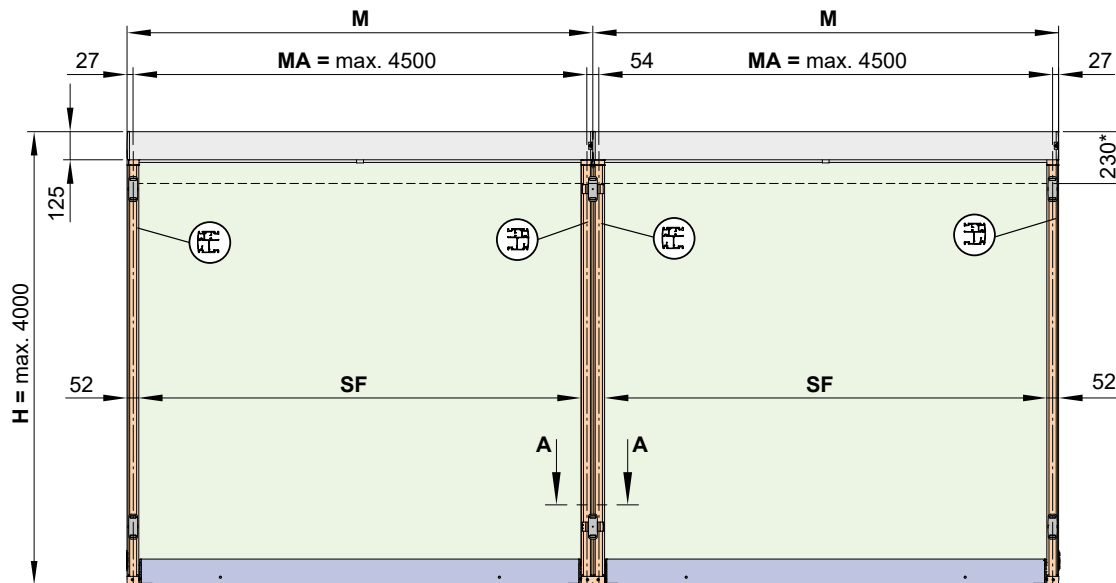

- \* = extension when retracted
- H = **order dimension** = extension
- HH = bracket height
- M = awning width
- MA = **order dimension** = blind fixture width = fixture width
- SF = visible cover

dimensions in mm

01  
02  
03  
04  
05  
06  
07  
08  
09  
10  
11  
12  
13  
14  
15  
16  
17  
18  
19

01 **Dimension overview Fixture type 21, 22**

02 **Fixtures, fittings and accessories**

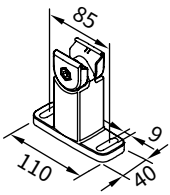

track bracket, with adjustable head  
100 mm

**76046.**

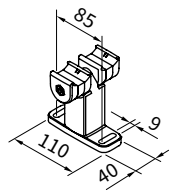

double track bracket with adjustable head 100 mm  
central bracket for 2 single units next to each other

**73634.**

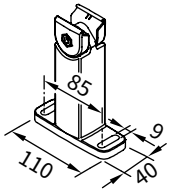

track bracket, with adjustable head  
140 mm

**76048.**

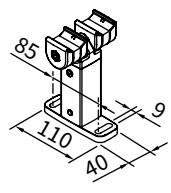

double track bracket with adjustable head 140 mm  
central bracket for 2 single units next to each other

**73636.**

15

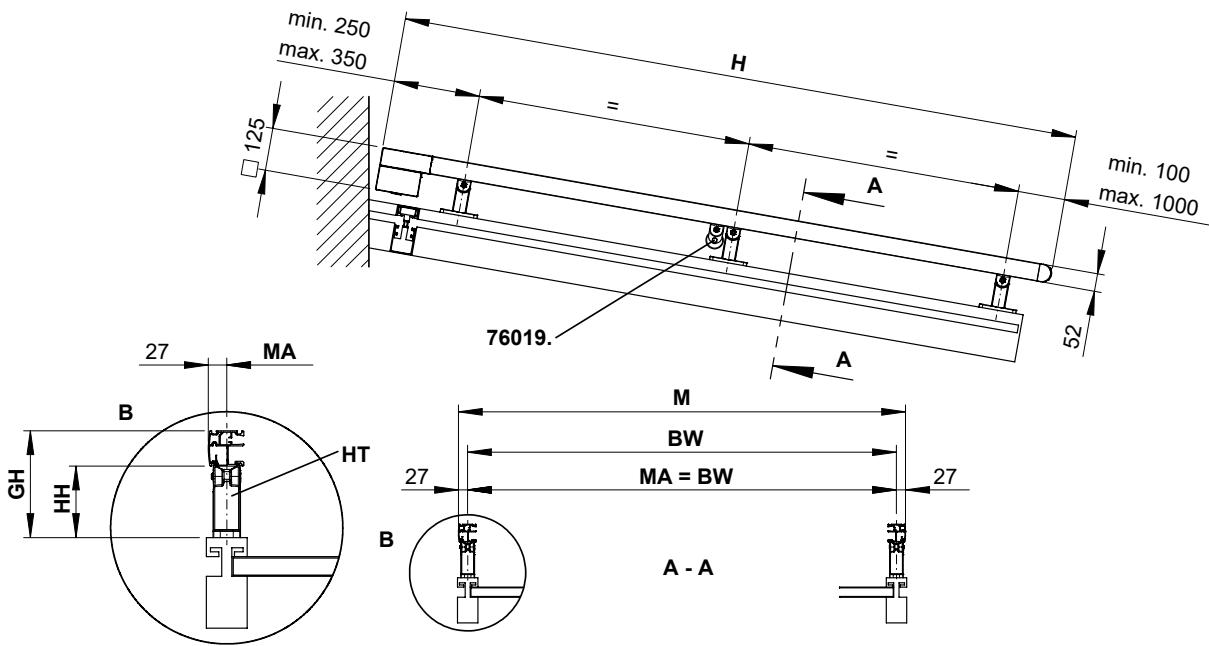

- 76019.** = bracket for cover support tube
- BW** = width between fixture points on the conservatory
- H** = **order dimension** = extension
- HH** = bracket height
- HT** = bracket
- M** = awning width
- MA** = **order dimension** = blind fixture width = fixture width

dimensions in mm

# Dimension overview fixture combination 30

Fixtures, fittings and accessories

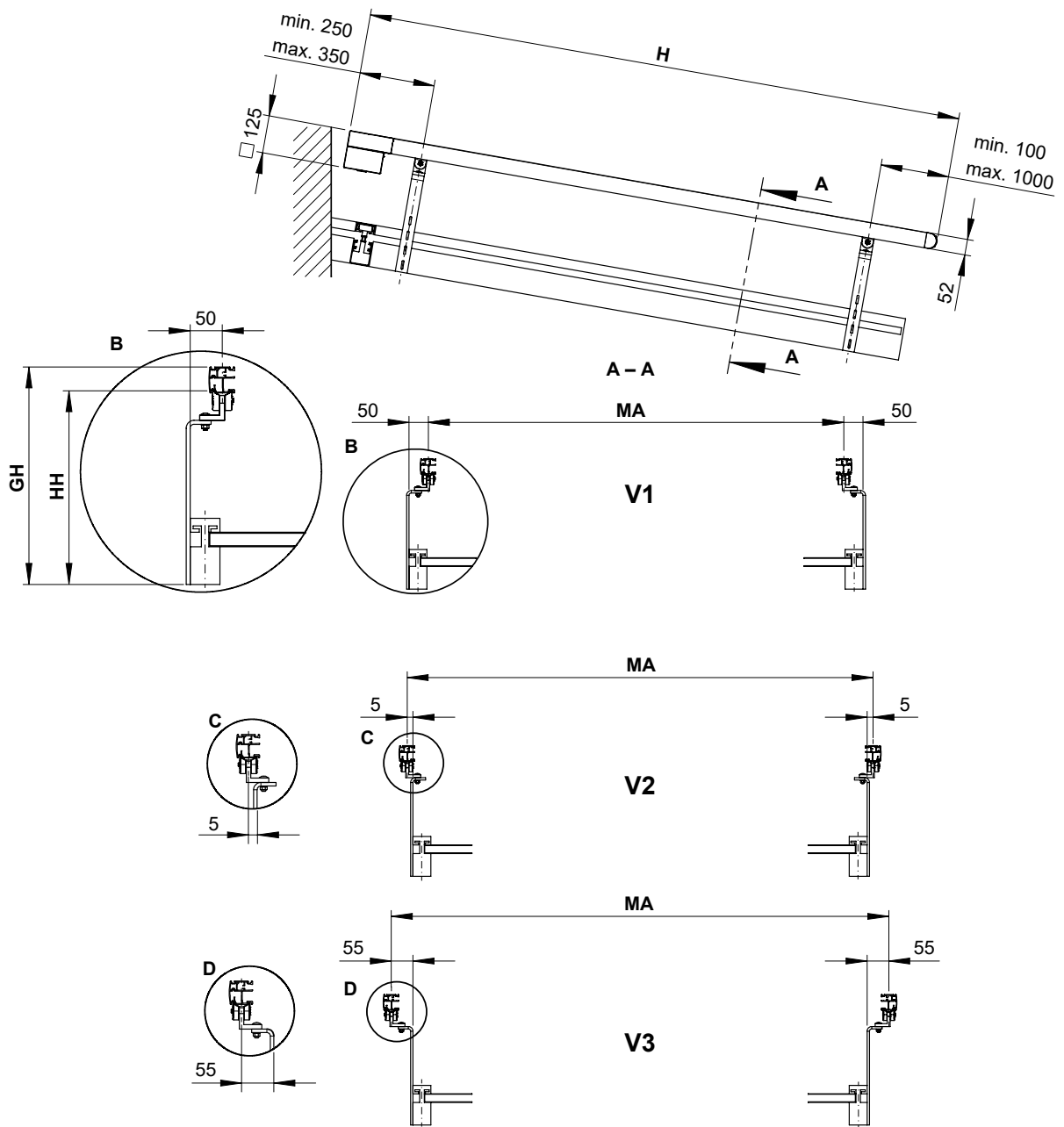
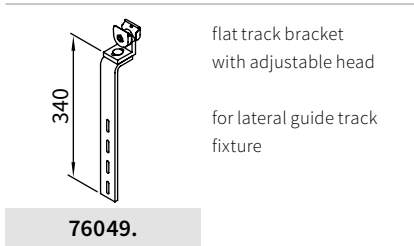

- H = order dimension = extension
- MA = order dimension = blind fixture width = fixture width
- V1, V2, V3 = variants

dimensions in mm

01  
02  
03  
04  
05  
06  
07  
08  
09  
10  
11  
12  
13  
14  
15  
16  
17  
18  
19

# Dimension overview eaves fixture with additional bracket fitting

Fixtures, fittings and accessories

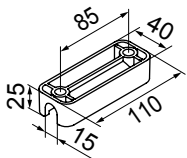

track bracket accessory  
width 14 mm

for direct assembly on  
conservatory rafters

**76804.**

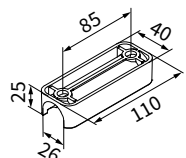

track bracket accessory  
width 25 mm

for direct assembly on  
conservatory rafters

**76805.**

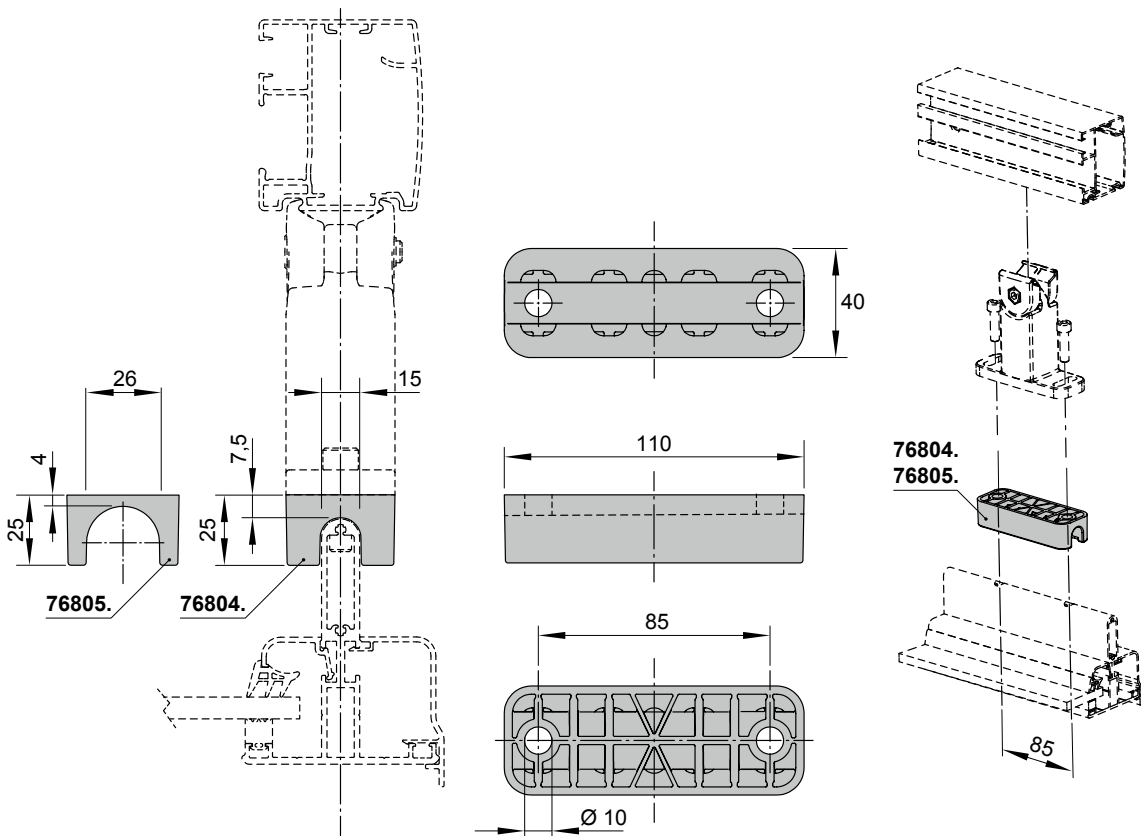

76804.  
76805.

dimensions in mm

# Motor cable exit point

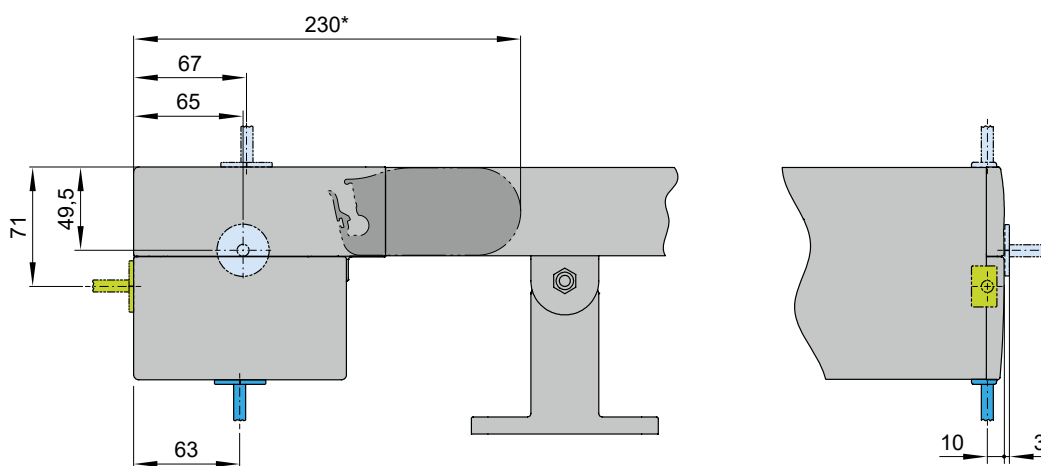

- 01
- 02
- 03
- 04
- 05
- 06
- 07
- 08
- 09
- 10
- 11
- 12
- 13
- 14
- 15**
- 16
- 17
- 18
- 19

- \* = extension when retracted
- = standard
- = optional
- = optionally with surcharge

dimensions in mm

01

02

03

04

05

06

07

08

09

10

11

12

13

14

**15**

16

17

18

19