

## C27 Electric 230v

### Features:

The YewdaleDefiant® C27 electric cassette blind features a strong headbox and 230v AC motor as standard. Designed for top or face fixing and accommodates 40mm grooved aluminium barrel which houses the motor. The motor is controlled by a switch which may be surface or flush mounted (not supplied as standard). Fabric is locked into groove in barrel and an aluminium bottom bar. Black or white hardware as standard.

- Quick and easy installation
- Block light with powder coated end plates
- Dedicated support team available to assist with installation and product enquiries
- Blackout options available

### Benefits:

The C27 offers a premium electric operated cassette blind for situations where durability and functionality are required. The quiet and reliable motor is housed within the barrel and further protected by the aluminium headbox housing. The fabric is locked into the barrel and bottom bar and will give years of trouble-free use. It is located in the groove so that it may be slid out sideways for easy repair or replacement of blind cover. You can choose between a square or rounded headbox to complete the blind and protect it from dust and damage.

### Options:

Square or rounded headbox; Black or white hardware; Remote and/or group control systems in place of single switch; With side channels C475-90/120; Wire side-guiding system; Available in any RAL colour.

### Specification:

YewdaleDefiant® C27-90/120 electric cassetted blind as manufactured by Yewdale, +44 (0)1268 570900. Flame retardant fabric from the YewdaleDefiant® range, locked into grooved 53/70mm aluminium barrel along with aluminium bottom bar as standard. 230v AC motor is housed within black/white aluminium cassette.

## Cassetted Blind Profile Dimension Guide

Model	Cassette Size (HxD)	Barrel Size Ø	Side Channel Size (WxD)
C27-90	Rounded / Square - 105 x 95mm	53mm	N/A
C27-120	Rounded / Square - 140 x 120mm	53 / 70mm	N/A

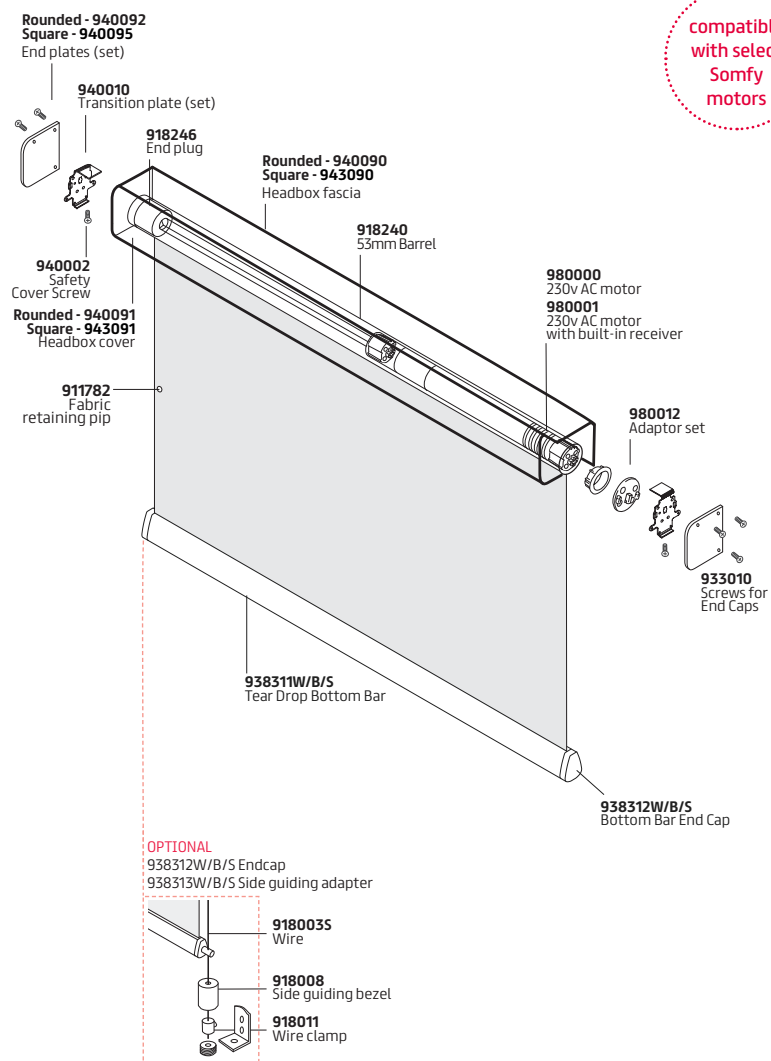

Find this product on  
NBS Source



# Cassette Headbox

Recommended Installation Clearance

yewdale **Defiant**<sup>®</sup>  
FABRIC AND BLIND SYSTEMS

Cassette 60

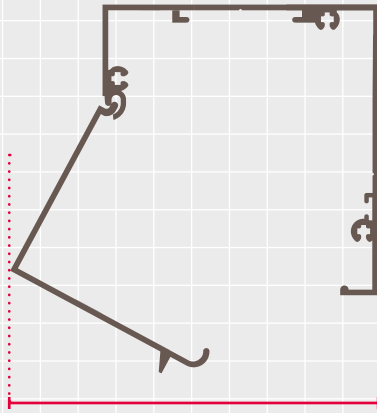

Min. Required: 95mm

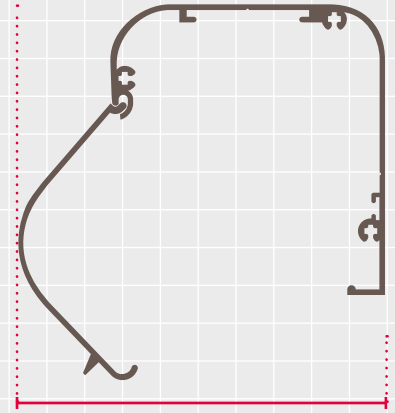

Min. Required: 95mm

Cassette 90

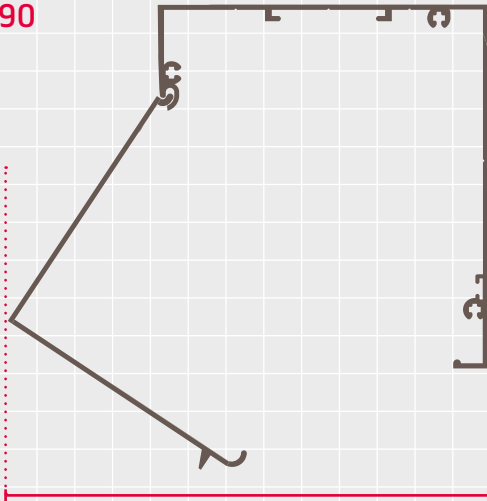

Min. Required: 145mm

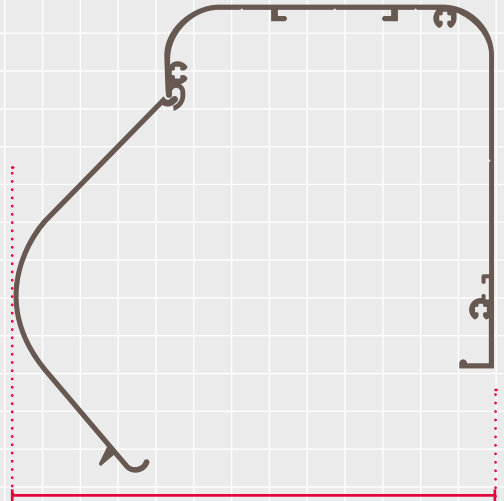

Min. Required: 145mm

Cassette 120

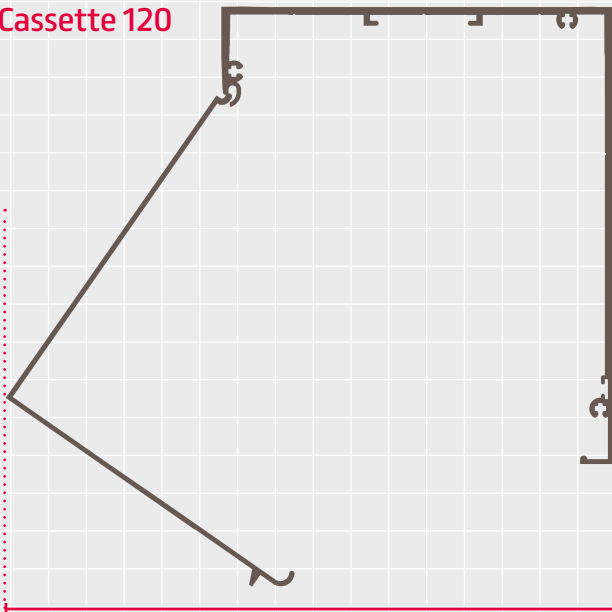

Min. Required: 185mm

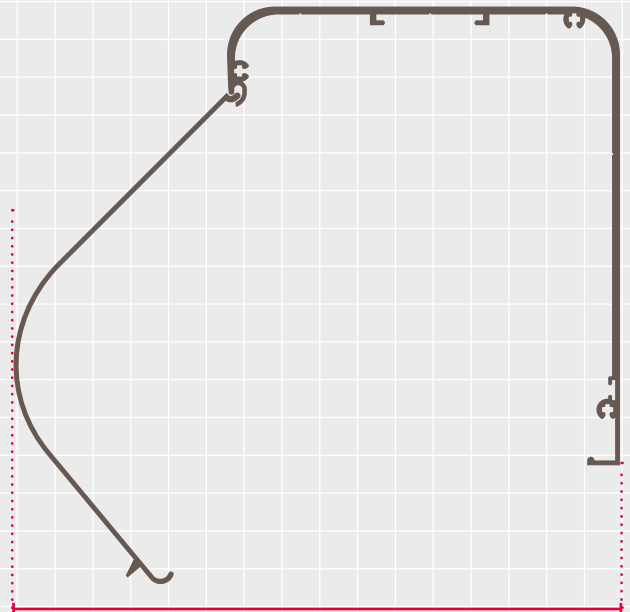

Min. Required: 185mm

All dimensions shown are indicative guidance only. The contractor/installer is responsible for verifying minimum space requirements prior to installation.